

# PRODUCT INFORMATION MODEL OD0618 BOOGIE

© 2018 KURT BEIER & KATI QUINGER



Swing and rocking function



As a single or double lounger





Practical stool

**OUTDOOR BOOGIE:** EXTRAVAGANT DESIGN.  
 MAXIMUM COMFORT. PURE RELAXATION. OPTIONALLY AVAILABLE AS  
 A ROTARY AND ROCKING CHAIR, ARMCHAIR, SOFA, LOUNGER AND  
 RECAMIERE. ELEMENTS WITH A CUSHION LOOK ON A METAL BASE  
 FRAME, MATT FINE STRUCTURE POWDER-COATED. LARGE SELECTION  
 OF OUTDOOR TEXTILES. UNIQUE PIECE PRODUCTION.

**Metal skids:** finestructure powder coated, 2 colours  
**Foot plate, type 139/145:** only available in black fine structure powder coated  
**Attention!** Maximum load with armchair type 139/145: up to 110 kg

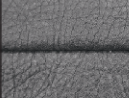
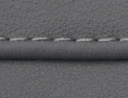

### Processing options of main seam / decorative seam

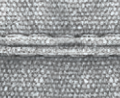
	Plain seam	Lap seam	KR* (zipper piping) extra charge	Overcast seam extra charge	Piping
					
Outdoor fabric	x				
Outdoor leather	x				

### Outdoor innercover

Additional protection against moisture penetration is provided by an inner cover made of waterproof fabric. The inner cover can be selected for the respective model at an extra charge. Please specify when ordering.

### Colours for metal skids

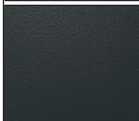
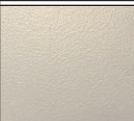
Black	Silk grey
	
✓	✓



*Model OD0618 Boogie is also available as indoor product!*

*For further informations refer to product information 0618 Boogie.*

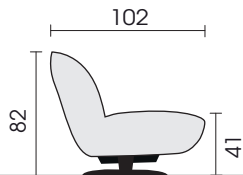

Side view (type 139)

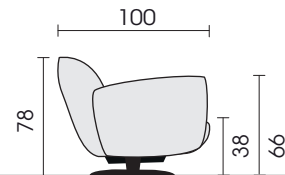

Side view (type 145)

Functional armchairs:

SD = Seat depth  
AR = Armrest

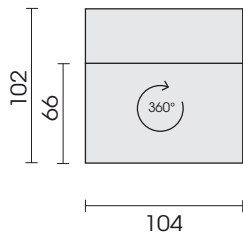

Element,  
turning and swing function  
**139**

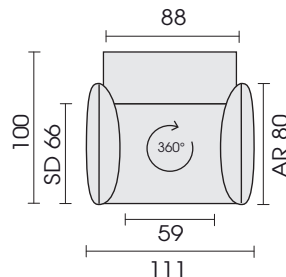

Element, 2 AR  
turning and swing function  
**145**

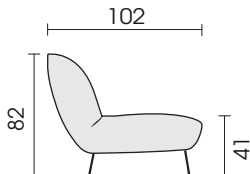

Side view (type 130)

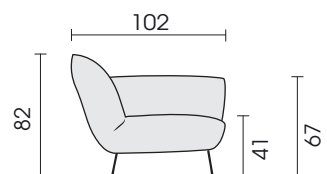

Side view (type 110/210)

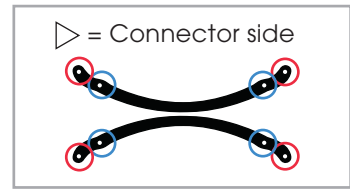

Solid elements:

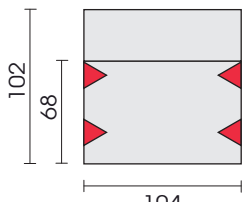

Element  
**130**

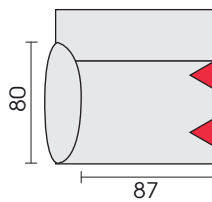

Element  
armrest left  
**120**

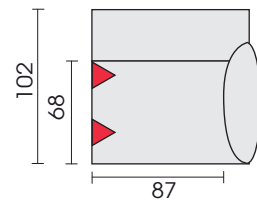

Element  
armrest right  
**110**

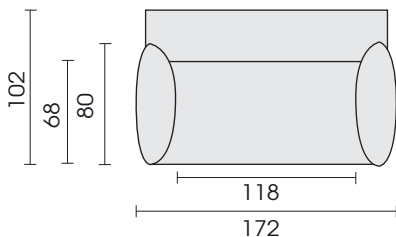

Sofa, 2-seat  
2 armrests  
**200**

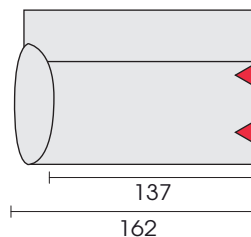

Sofa, 2-seat  
armrest left  
**220**

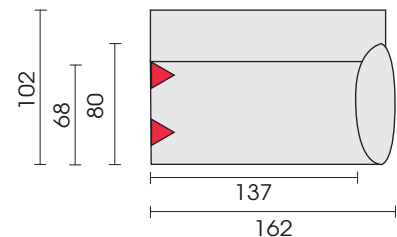

Sofa, 2-seat  
armrest right  
**210**

Each piece of furniture is handmade and unique. Deviations to the listed measurements may be caused by:  
1. different upholstery materials (fabric, leather), 2. processing of ticking mats, 3. the pressure to combine individual parts, etc.  
The seat comfort of a sofa type with larger seat depth usually differs from one with lower depth.

Deep elements:

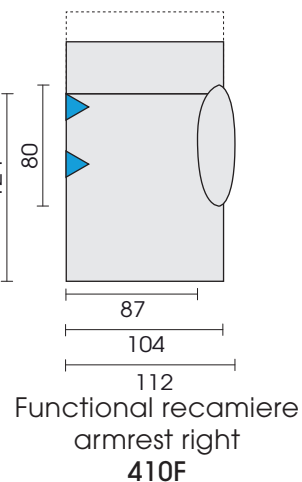
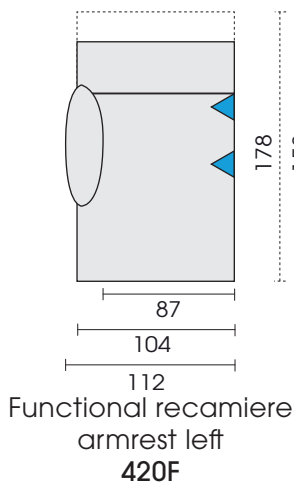
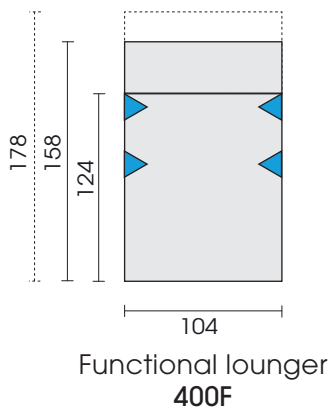
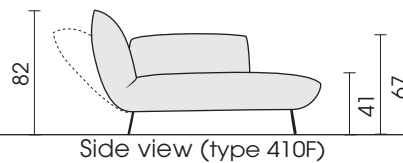
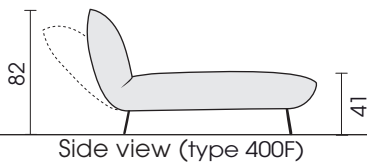
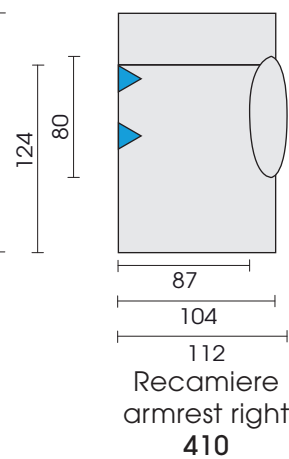
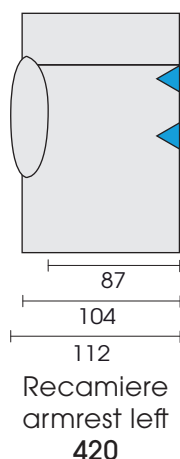
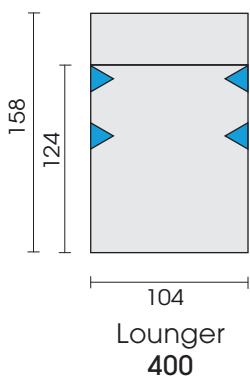
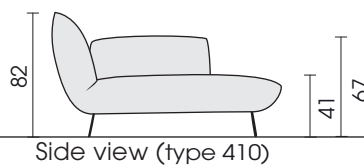
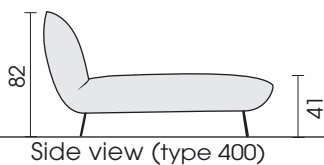
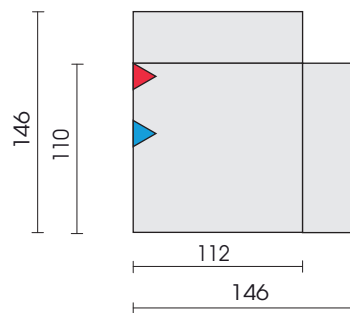
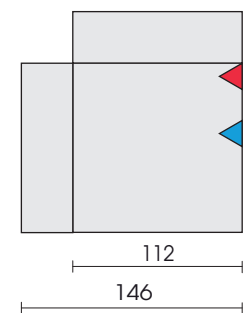
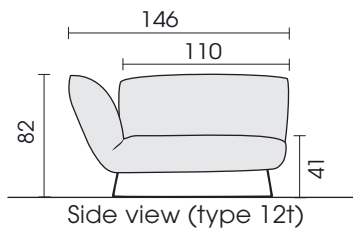

Each piece of furniture is handmade and unique. Deviations to the listed measurements may be caused by:  
1. different upholstery materials (fabric, leather), 2. processing of ticking mats, 3. the pressure to combine individual parts, etc.  
The seat comfort of a sofa type with larger seat depth usually differs from one with lower depth.

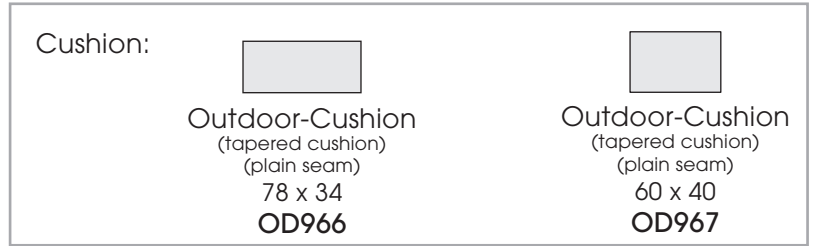
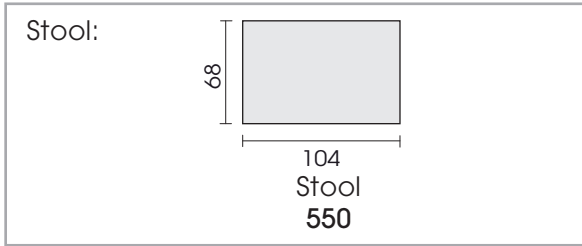

**Protective covers** (Waterproof):

Protective cover for type 130/139: SH139	Protective cover for type 220: SH220
Protective cover for type 145: SH145	Protective cover for type 11t/12t: SH11t
Protective cover for type 110: SH110	Protective cover for type 410/410F: SH410
Protective cover for type 120: SH120	Protective cover for type 420/420F: SH420
Protective cover for type 200: SH200	Protective cover for type 400/400F: SH400
Protective cover for type 210: SH210	Protective cover for type 550: SH550

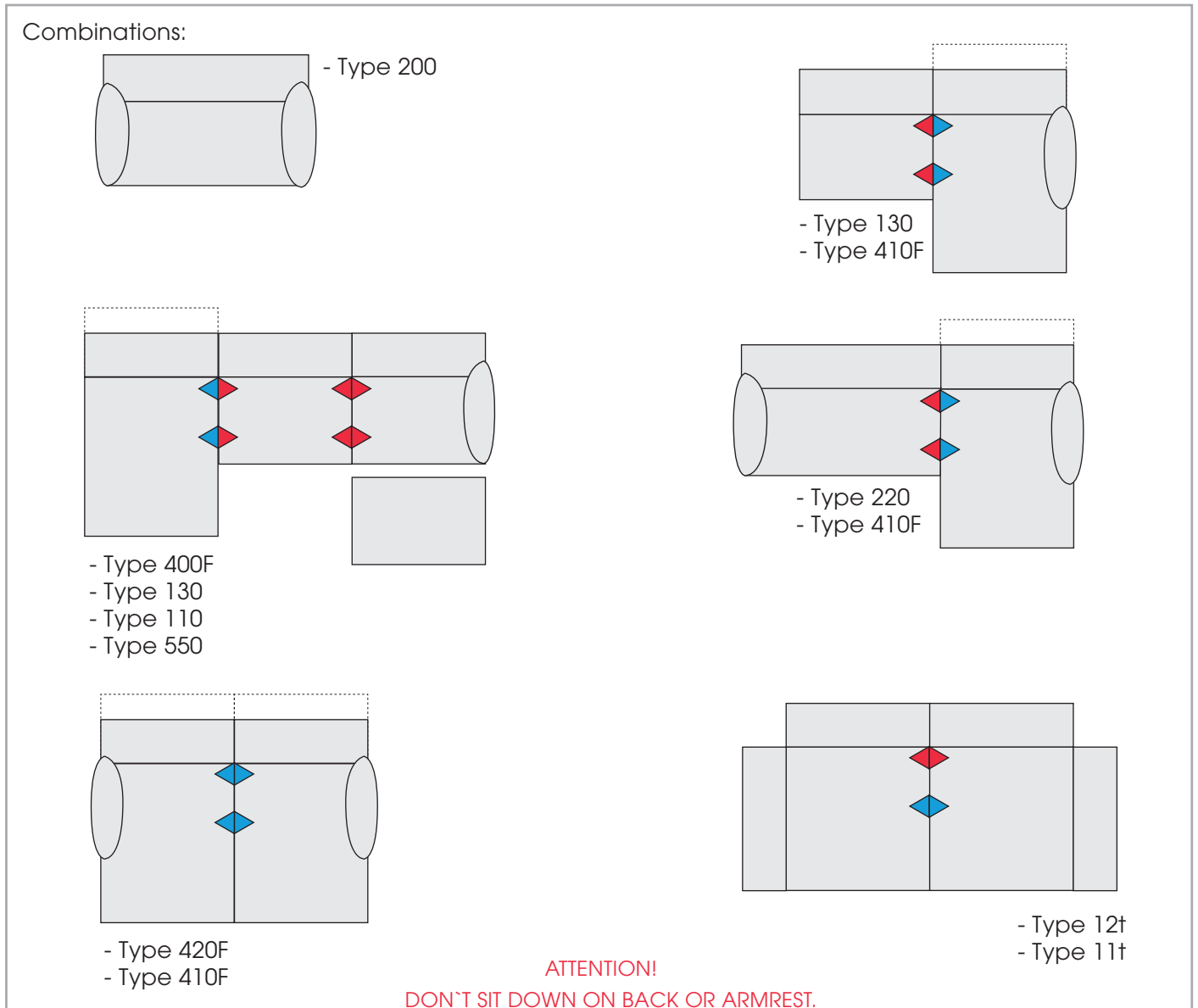

Each piece of furniture is handmade and unique. Deviations to the listed measurements may be caused by:  
 1. different upholstery materials (fabric, leather), 2. processing of ticking mats, 3. the pressure to combine individual parts, etc.  
 The seat comfort of a sofa type with larger seat depth usually differs from one with lower depth.