

PRODUCT INFORMATION MODEL 1070 IWAN

© 2016 KURT BEIER & KATI QUINGER









IWAN: DESIGNER'S FAVOURITE. EXPERIENCE A NEW WAY OF LIVING. ON YOUR OWN OR WITH COMPANY. A FAVOURITE SPOT, SENSUAL AND PURISTIC AT THE SAME TIME. WHETHER AS A SOLITAIRE OR AS A CORNER ENSEMBLE - THE CREATIVE SEATING AND LOUNGING ELEMENTS CAN BE COMBINED IN MULTIPLE WAYS ALLOWING FOR INDIVIDUAL ROOM DESIGN. THE FUNCTIONAL CUSHIONS IN DIFFERENT SIZES SET THE CREATIVE STYLE OF THE MODEL. LARGE SELECTION OF SPECIAL FABRICS AND LEATHERS. ALSO AVAILABLE FOR OUTDOOR USE. UNIQUE PIECE PRODUCTION.

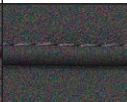

Feet: 7 cm, plastic glides. **Optionally** wooden feet (extra charge): 13 cm, cylindrical, black lacquered or 7 cm lockable castors (extra charge). Attention! Castors cannot be fitted to type 230P.
Floor distance: approx. 7 cm or 13 cm.

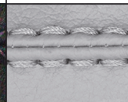

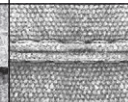
Corpus - Processing options of main seam / decorative seam

	Plain seam	Lap seam	Raw edged	Moccasin seam extra charge	Twin seam extra charge	KR* (zipper piping) extra charge	Overcast seam extra charge	Piping	Two-needle seam	Manufact seam square extra charge
										
Fabric	x									
Leather	x		x							

It is possible to order main seam or decorative seam either tone in tone like the colours of cover or in the contrasting colours white, nature, grey, rust and black. On request special colours possible.

*Zipper piping: optionally in the colours black, red, nature or light grey.

Only the following leathers are used for seat elements:

2055 Toro / 2070 Sierra / 2100 Oasis / 2120 Desperado / 2180 Navajo / 2210 Jungle / 2399 Rhino / 2510 Crazy Nubuk
2600 Alpaca / 26 Royal Nappa

Thick leather 2625 Crazy Neck processing is only possible with seat elements (only raw edged workmanship).

The following fabrics cannot be used for seat elements:

15 Powder / 15 Fuzzy / 11 Roger

Back - Processing options of main seam / decorative seam

	Plain seam	Raw edged	 <p>Only the following leathers are used for functional backs Moba: 2055 Toro / 2070 Sierra / 2100 Oasis / 2120 Desperado / 2180 Navajo / 2210 Jungle / 2399 Rhino / 2510 Crazy Nubuk / 2600 Alpaca / 26 Royal Nappa</p>
			
Fabric	x		
Leather	x	x	
Fake fur	x		

It is possible to order main seam or decorative seam either tone in tone like the colours of cover or in the contrasting colours white, nature, grey, rust and black. On request special colours possible.

Option: removable covers, fabric:

All types (except type 230P) are also available with a removable cover. Please specify this when placing your order.

Element connectors CANNOT be installed on seating elements with removable covers!

Variants, feet/castors:



Wooden feet
(extra charge)
13 cm



Lockable castors
(extra charge)
7 cm

103
approx. 45

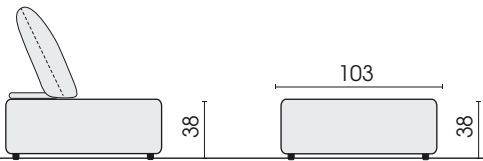

Attention! For an extra charge it is possible to mount element connectors!

Side view (with back type 611)

Seat elements:

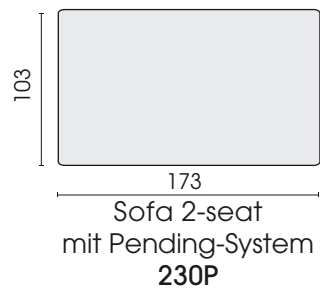
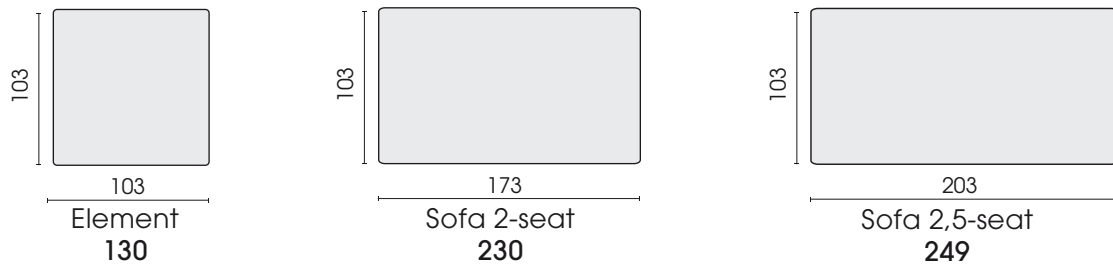

Attention!
With sofa type 230P NO
element connectors or castors can be fitted!

111
approx. 45

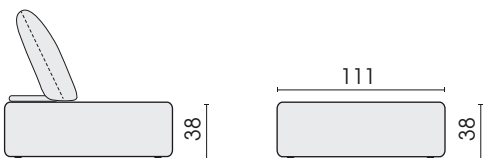

Side view seat element, deep (with back type 611)

Seat elements, deep:

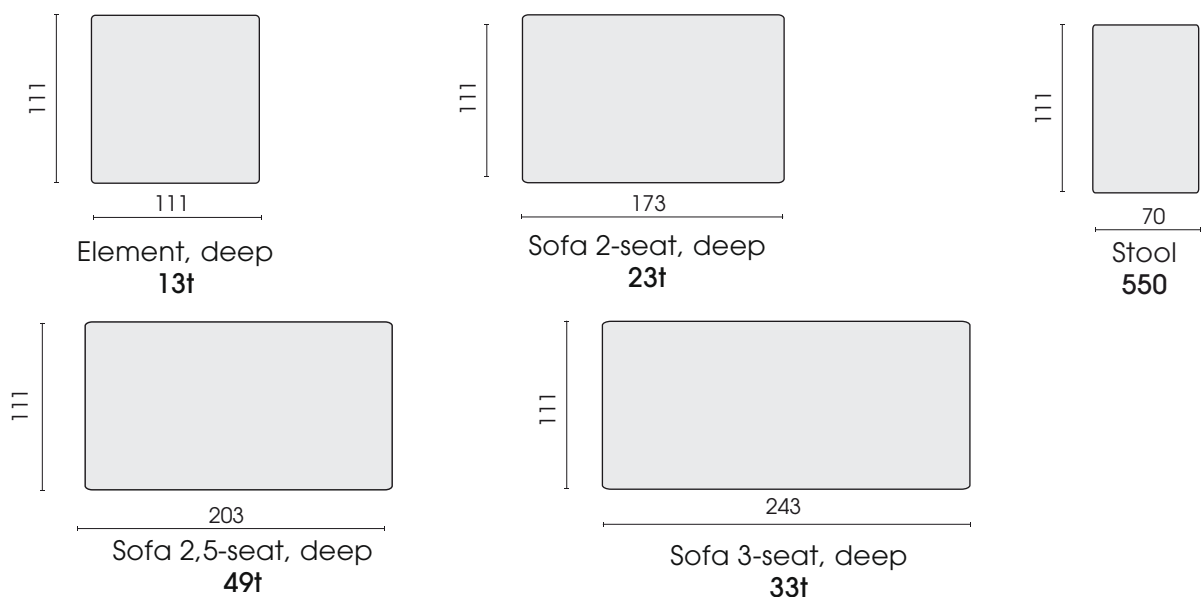

Each piece of furniture is handmade and unique. Deviations to the listed measurements may be caused by:
1. different upholstery materials (fabric, leather), 2. processing of ticking mats, 3. the pressure to combine individual parts, etc.
The seat comfort of a sofa type with larger seat depth usually differs from one with lower depth.

---- Dividing seam ▷ = Connector side

For the connection with the corner element 70t, the assembly of element connectors (for an extra charge) is recommended!

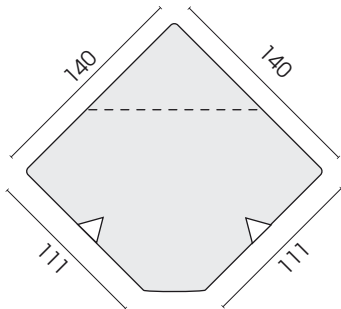

Corner element, deep
70t

The elements 216t & 215t can only be connected to each other on the slanted side!
For the elements 216t / 215t, the assembly of element connectors (for an extra charge) is recommended!

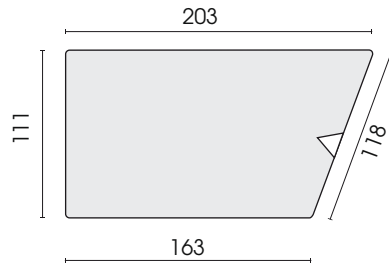

Segment 2-seat
left
216t

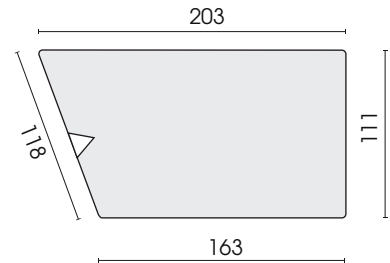

Segment 2-seat
right
215t

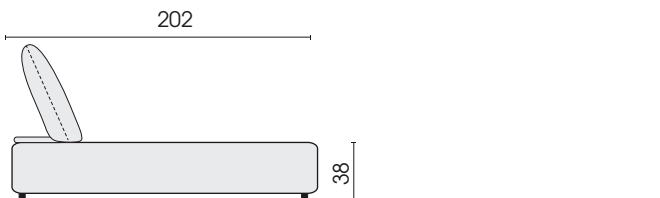

Side view (with back type 614)

Lounger & corner element:

For the connection with the corner part 80t, the assembly of element connectors (for an extra charge) is recommended!

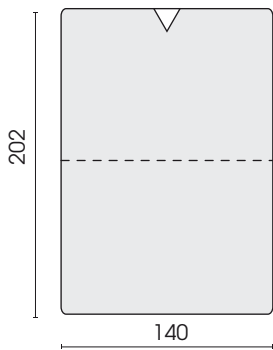

Lounger, wide
440

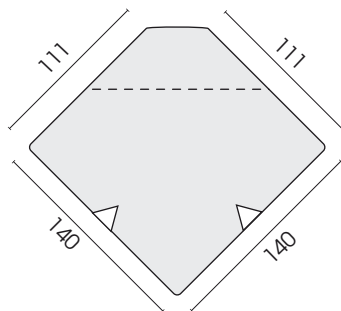

Corner element, deep
80t

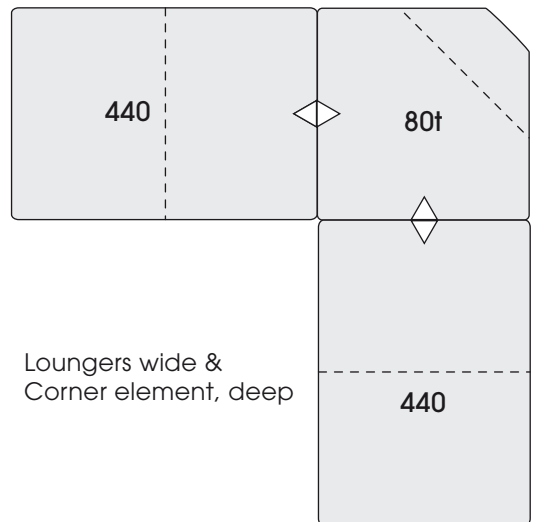

Loungers wide &
Corner element, deep

Stools:

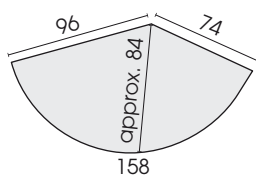

Stool, semi-circular, left
530L

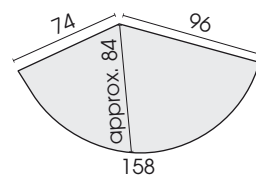

Stool, semi-circular, right
530R

Each piece of furniture is handmade and unique. Deviations to the listed measurements may be caused by:
1. different upholstery materials (fabric, leather), 2. processing of ticking mats, 3. the pressure to combine individual parts, etc.
The seat comfort of a sofa type with larger seat depth usually differs from one with lower depth.

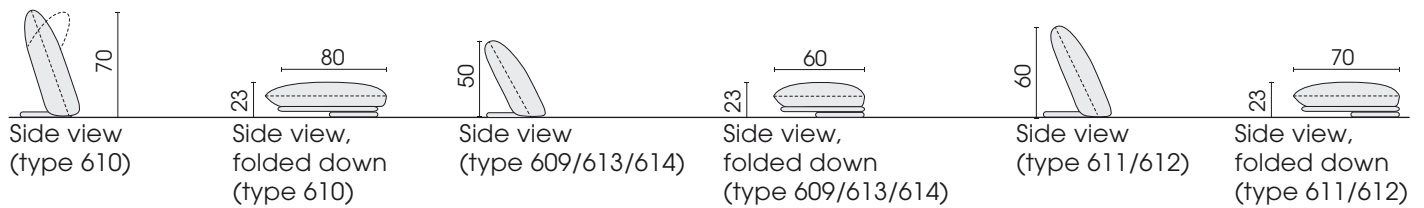

Backs:

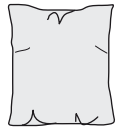

Moba S
double functional back
(tapered cushion)
70 x 80
610

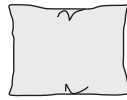

Moba NB
Functional back
(tapered cushion)
80 x 60
609

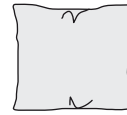

Moba B
Functional back
(tapered cushion)
80 x 70
611



Moba XB
Functional back
(tapered cushion)
95 x 70
612



Moba XN
Functional back
(tapered cushion)
95 x 60
613



Moba XLN
Functional back
(tapered cushion)
125 x 60
614

Cushions with decorative seams are either tone in tone or contrasting colour possible.



Cushion
(tapered cushion)
(fabric: decorative
overcast seam)
60 x 40
925



Cushion
(tapered cushion)
(plain seam)
78 x 60
949



Cushion
(tapered cushion)
(plain seam)
60 x 40
967



Cushion
(with dart)
(fabric: plain seam)
(leather: lap seam)
50 x 50
972



Cushion
(with dart)
(fabric: plain seam)
(leather: lap seam)
58 x 58
973



Cushion
(tapered cushion)
(leather: raw edged)
60 x 40
975

Slide table 1117, solid wood (available in different wood types):

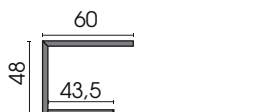

Side view (type 866)

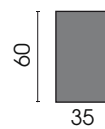
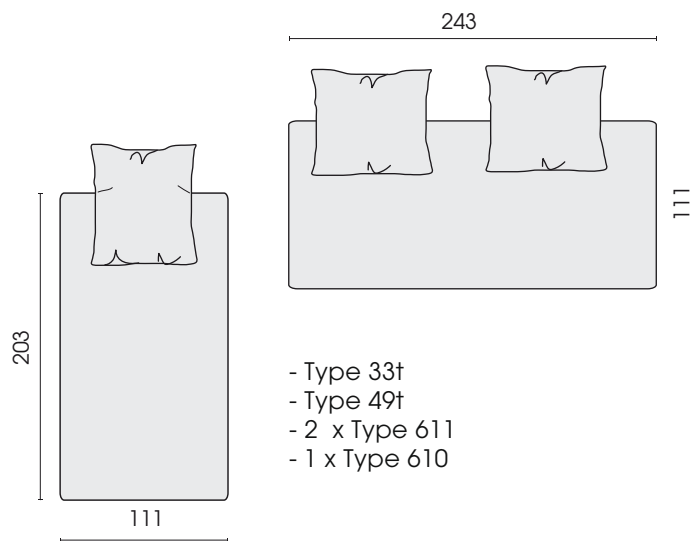
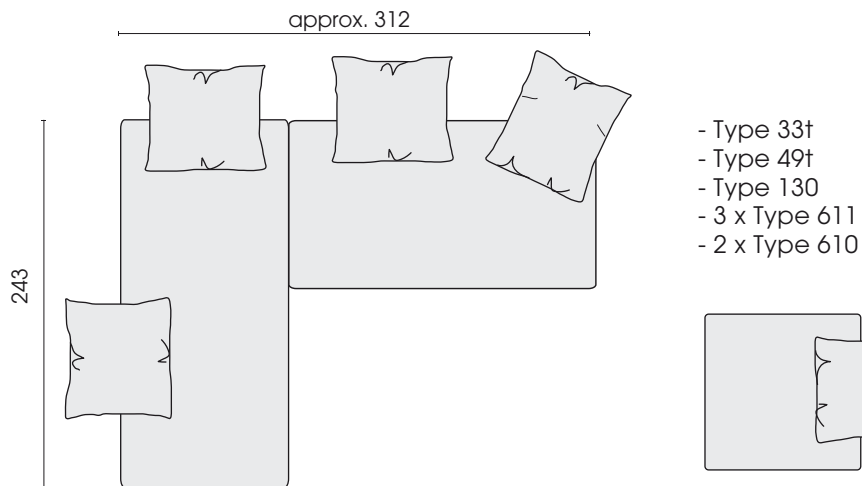
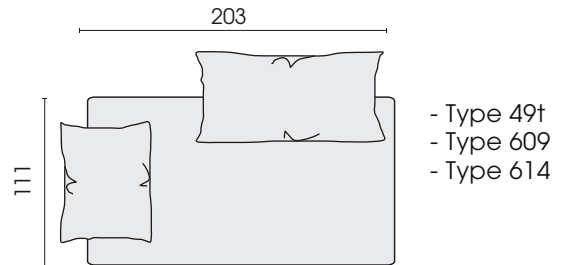
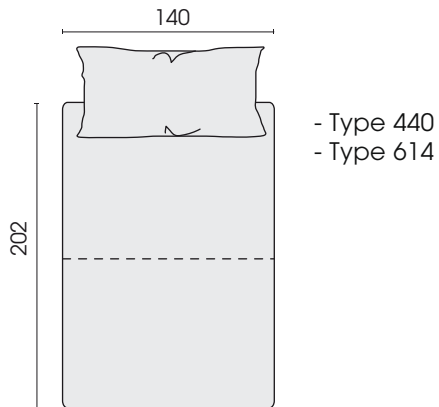

Table
to push
866

Each piece of furniture is handmade and unique. Deviations to the listed measurements may be caused by:
1. different upholstery materials (fabric, leather), 2. processing of ticking mats, 3. the pressure to combine individual parts, etc.
The seat comfort of a sofa type with larger seat depth usually differs from one with lower depth.

Combinations



Each piece of furniture is handmade and unique. Deviations to the listed measurements may be caused by:
1. different upholstery materials (fabric, leather), 2. processing of ticking mats, 3. the pressure to combine individual parts, etc.
The seat comfort of a sofa type with larger seat depth usually differs from one with lower depth.

Combinations

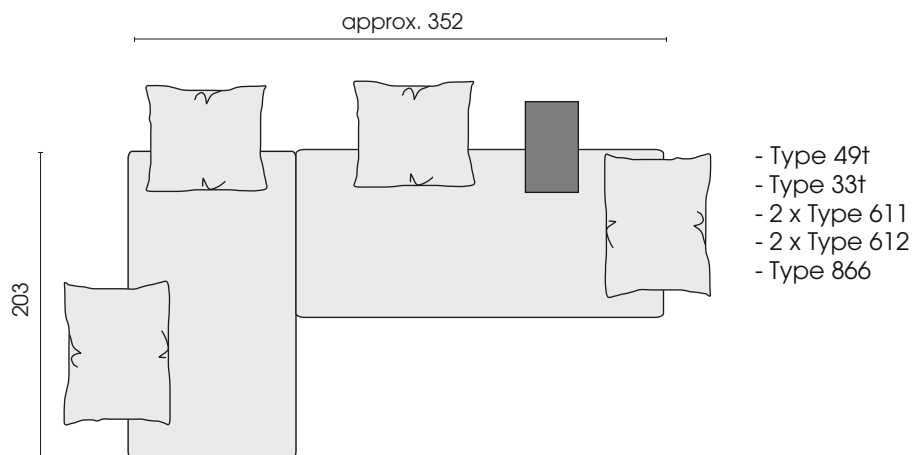
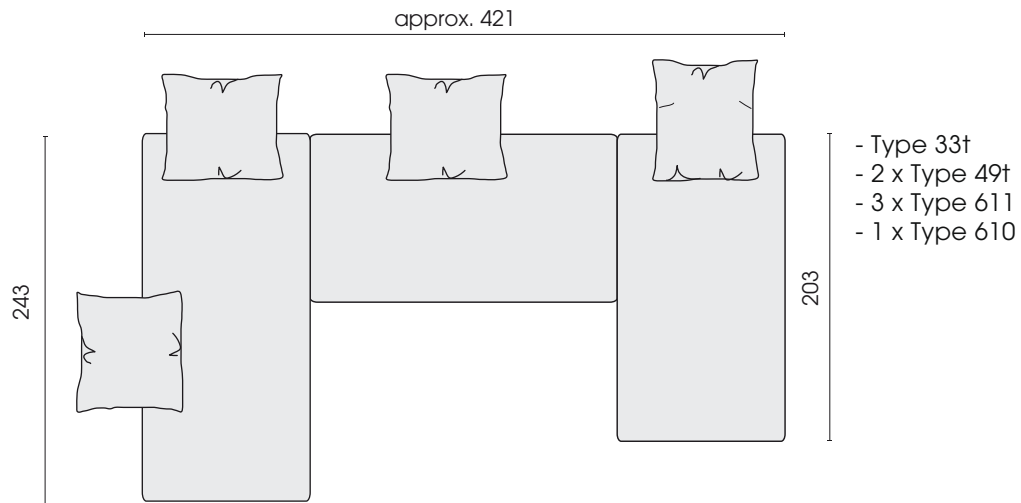

Each piece of furniture is handmade and unique. Deviations to the listed measurements may be caused by:
 1. different upholstery materials (fabric, leather), 2. processing of ticking mats, 3. the pressure to combine individual parts, etc.
 The seat comfort of a sofa type with larger seat depth usually differs from one with lower depth.

Combinations

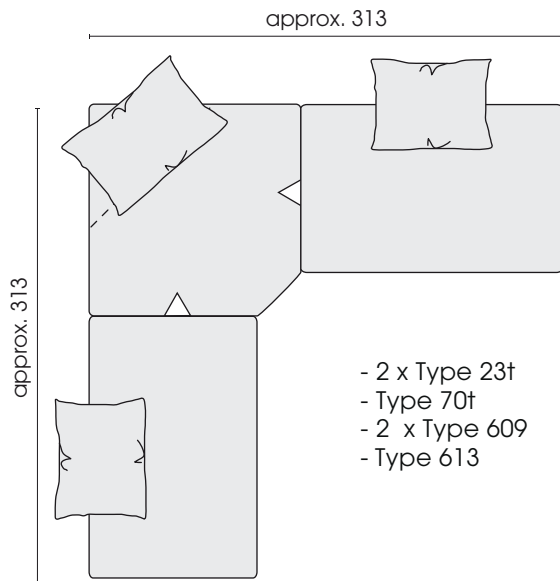

- 2 x Type 23t
- Type 70t
- 2 x Type 609
- Type 613

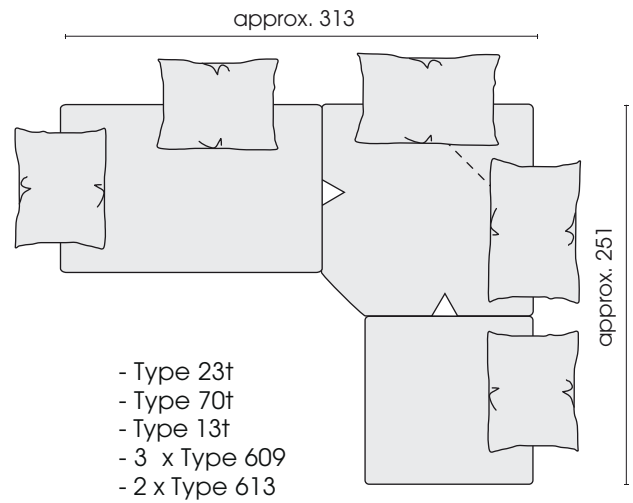

- Type 23t
- Type 70t
- Type 13t
- 3 x Type 609
- 2 x Type 613

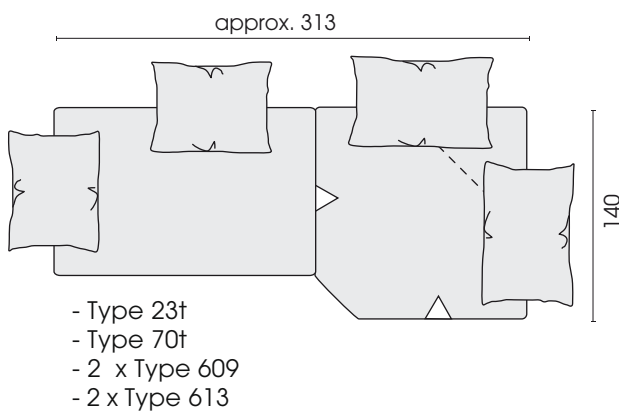

- Type 23t
- Type 70t
- 2 x Type 609
- 2 x Type 613

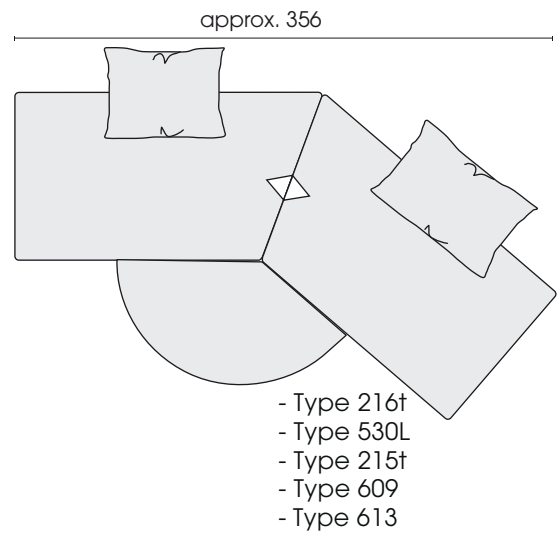

- Type 216t
- Type 530L
- Type 215t
- Type 609
- Type 613

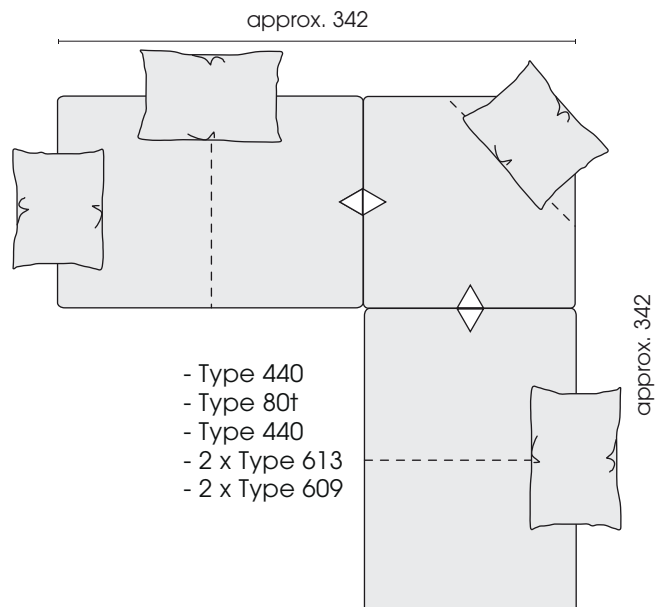

- Type 440
- Type 80t
- Type 440
- 2 x Type 613
- 2 x Type 609

Each piece of furniture is handmade and unique. Deviations to the listed measurements may be caused by:
 1. different upholstery materials (fabric, leather), 2. processing of ticking mats, 3. the pressure to combine individual parts, etc.
 The seat comfort of a sofa type with larger seat depth usually differs from one with lower depth.