

PRODUCT INFORMATION MODEL OD1070 IWAN

© 2016 KURT BEIER & KATI QUINGER





OD IWAN: THE CREATIVE LOUNGE. A TOTALLY NEW OUTDOOR EXPERIENCE - ON YOUR OWN OR WITH COMPANY. WHETHER AS A SOLITAIRE OR AS A CORNER ENSEMBLE. THE CREATIVE SEATING AND LOUNGING ELEMENTS CAN BE COMBINED IN MANY DIFFERENT WAYS. THE FUNCTIONAL CUSHIONS IN DIFFERENT SIZES SET THE CREATIVE STYLE OF THE MODEL. LARGE SELECTION OF OUTDOOR FABRICS. MATCHING WIND- AND RAINPROOF COVERS. ALSO AVAILABLE FOR INDOOR USE. UNIQUE PIECE PRODUCTION.

Feet: 7 cm plastic glides or 7 cm lockable castors (extra charge)
Attention! Castors cannot be fitted to type 230P.
Floor distance: approx. 6 cm

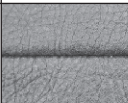
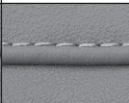

Processing options of main seam / decorative seam, Elements

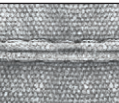
	Plain seam	Lap seam	KR* (zipper piping) extra charge	Overcast seam extra charge	Piping
					
Outdoor fabric	x				
Outdoor leather	x				

*Zipper piping: optionally in the colours black, red, nature or light grey.

Outdoor innercover

Additional protection against moisture penetration is provided by an inner cover made of waterproof fabric. The inner cover can be selected for the respective model at an extra charge.

Please specify when ordering.

Option: removable cover, fabric:

All types (except type 230P) are also available with a removable cover. Please specify this when placing your order.

Note: Removable seat elements are already equipped with an outdoor inner cover

Element connectors CANNOT be installed on seating elements with removable covers!

Variants, feet/castors:



Plastic glides
7 cm



Lockable castors
(extra charge)
7 cm

*Model OD1070 Iwan is also available as indoor product!
For further informations refer to product information 1070 Iwan.*

103
approx. 45

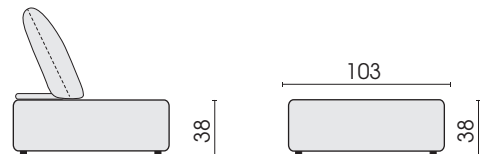

Note! For an extra charge it is possible to mount element connectors!

Side view (with back: type 611)

Seat elements:

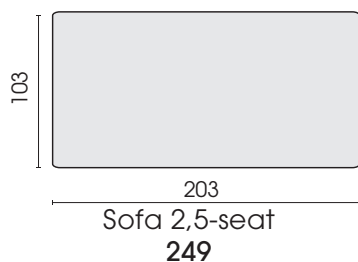
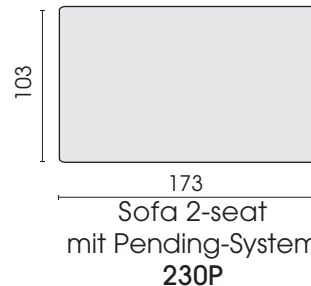
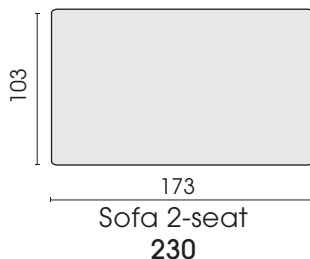
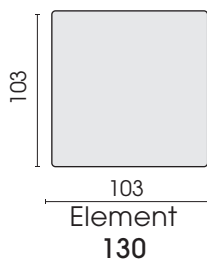

Attention!
With sofa type 230P NO
element connectors or castors can be fitted!

111
approx. 45

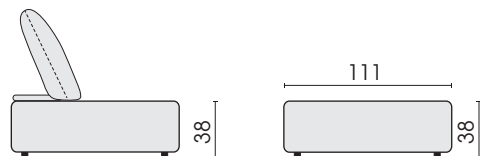

Side view, seat element, deep (with back, type 611)

Seat element, deep:

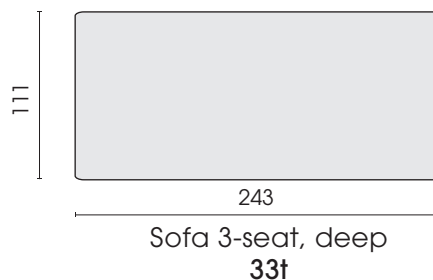
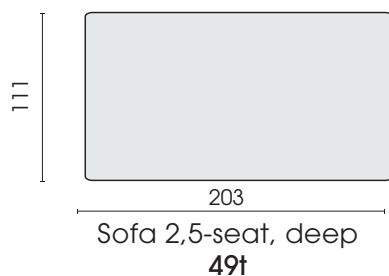
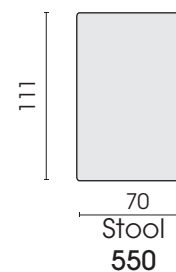
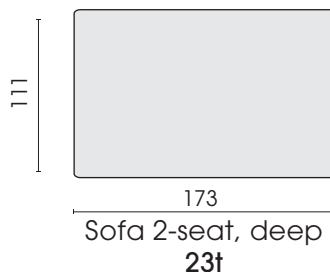
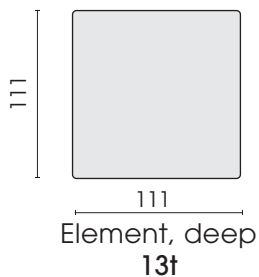

Each piece of furniture is handmade and unique. Deviations to the listed measurements may be caused by:
1. different upholstery materials (fabric, leather), 2. processing of ticking mats, 3. the pressure to combine individual parts, etc.
The seat comfort of a sofa type with larger seat depth usually differs from one with lower depth.

---- Dividing seam ▷ = Connector side

For the connection with the corner element 70t, the assembly of element connectors (for an extra charge) is recommended!

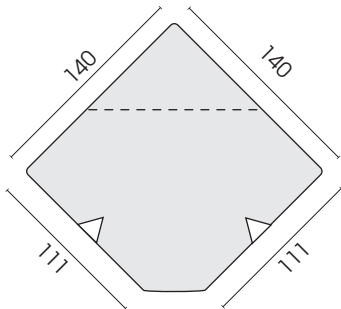

Corner element, deep
70t

The elements 216t & 215t can only be connected to each other on the slanted side! For the elements 216t / 215t, the assembly of element connectors (for an extra charge) is recommended!

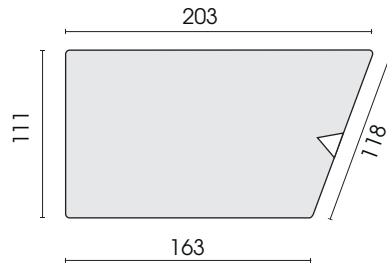

Segment 2-seat
left
216t

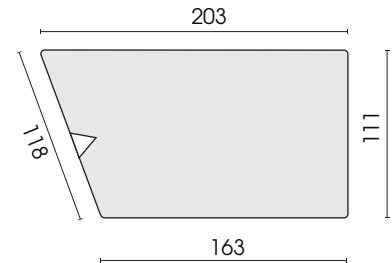

Segment 2-seat
right
215t

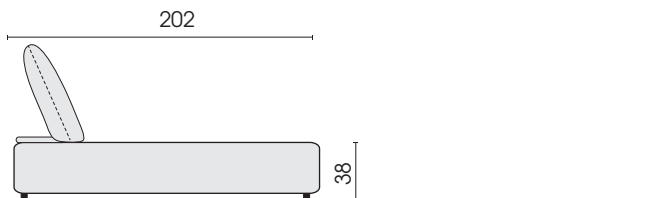

Side view (with back type 614)

Lounger & corner element:

For the connection with the corner part 80t, the assembly of element connectors (for an extra charge) is recommended!

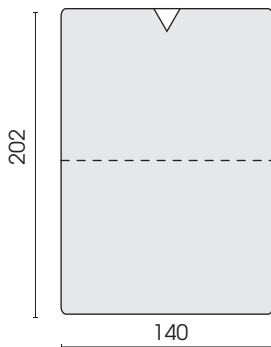

Lounger, wide
440

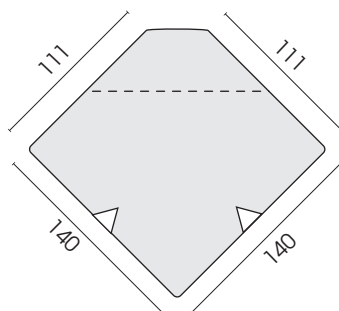

Corner element, deep
80t

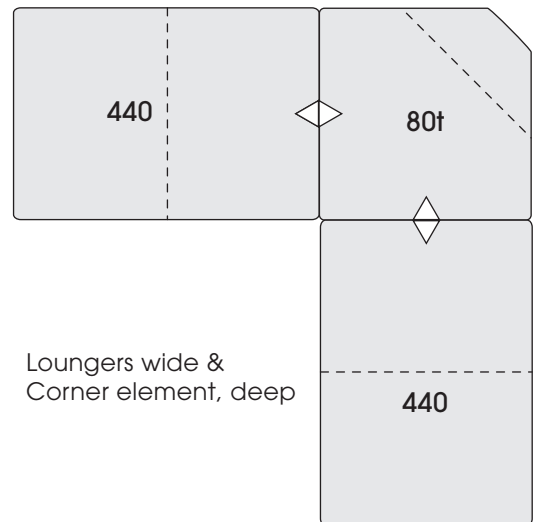

Loungers wide &
Corner element, deep

Stools:

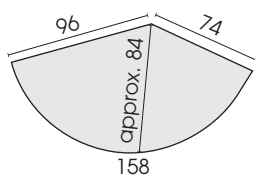

Stool, semi-circular, left
530L

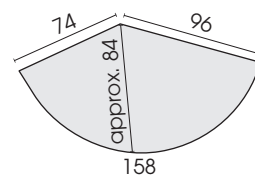

Stool, semi-circular, right
530R

Each piece of furniture is handmade and unique. Deviations to the listed measurements may be caused by:
1. different upholstery materials (fabric, leather), 2. processing of ticking mats, 3. the pressure to combine individual parts, etc.
The seat comfort of a sofa type with larger seat depth usually differs from one with lower depth.

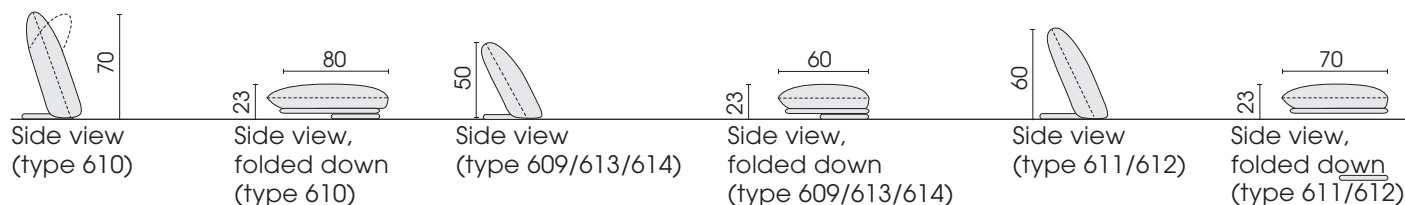

Functional backs:

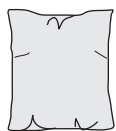

Moba S
double functional back
(tapered cushion)
70 x 80
610

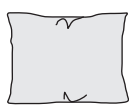

Moba NB
Functional back
(tapered cushion)
80 x 60
609

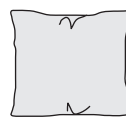

Moba B
Functional back
(tapered cushion)
80 x 70
611

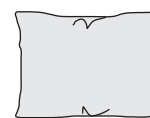

Moba XB
Functional back
(tapered cushion)
95 x 70
612



Moba XN
Functional back
(tapered cushion)
95 x 60
613



Moba XLN
Functional back
(tapered cushion)
125 x 60
614

Protective cover (waterproof):

Protective cover for type 13t: SH13t
 Protective cover for type 23t: SH23t
 Protective cover for type 33t: SH33t
 Protective cover for type 49t: SH49t
 Protective cover for type 130: SH130
 Protective cover for type 230/230P: SH230
 Protective cover for type 249: SH249
 Protective cover for type 440: SH440

Protective cover for type 550: SH550
 Protective cover for type 530L: SH530L
 Protective cover for type 530R: SH530R
 Protective cover for type 215t: SH215t
 Protective cover for type 216t: SH216t
 Protective cover for type 70t: SH70t
 Protective cover for type 80t: SH80t

Combinations

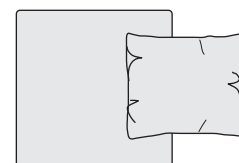
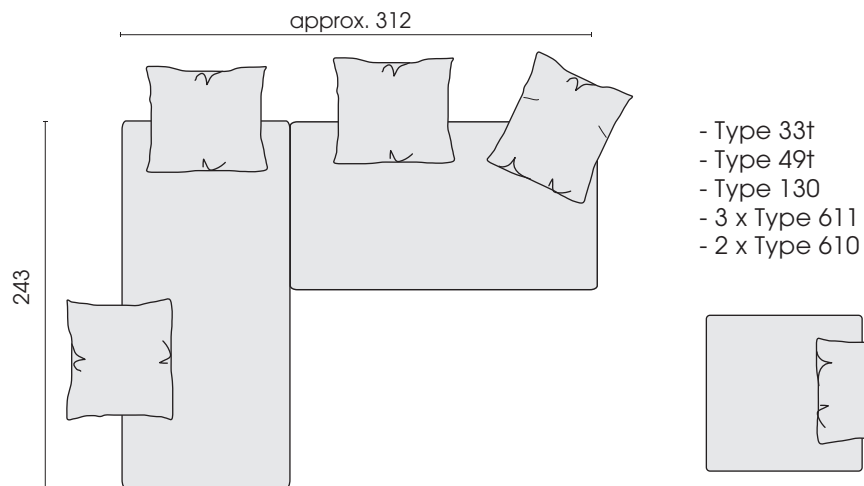
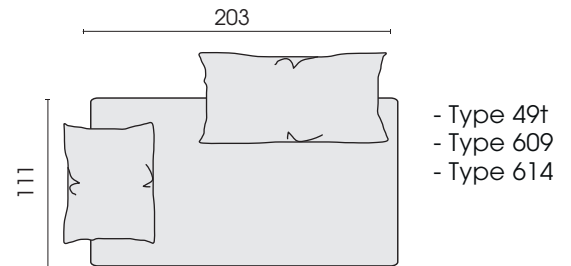
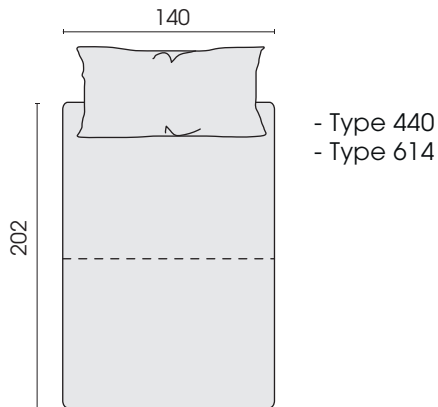

Each piece of furniture is handmade and unique. Deviations to the listed measurements may be caused by:
 1. different upholstery materials (fabric, leather), 2. processing of ticking mats, 3. the pressure to combine individual parts, etc.
 The seat comfort of a sofa type with larger seat depth usually differs from one with lower depth.

Combinations

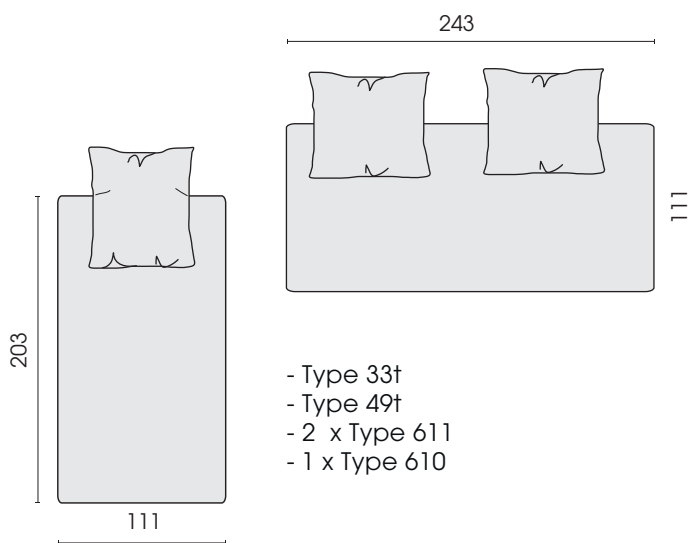

- Type 33t
- Type 49t
- 2 x Type 611
- 1 x Type 610

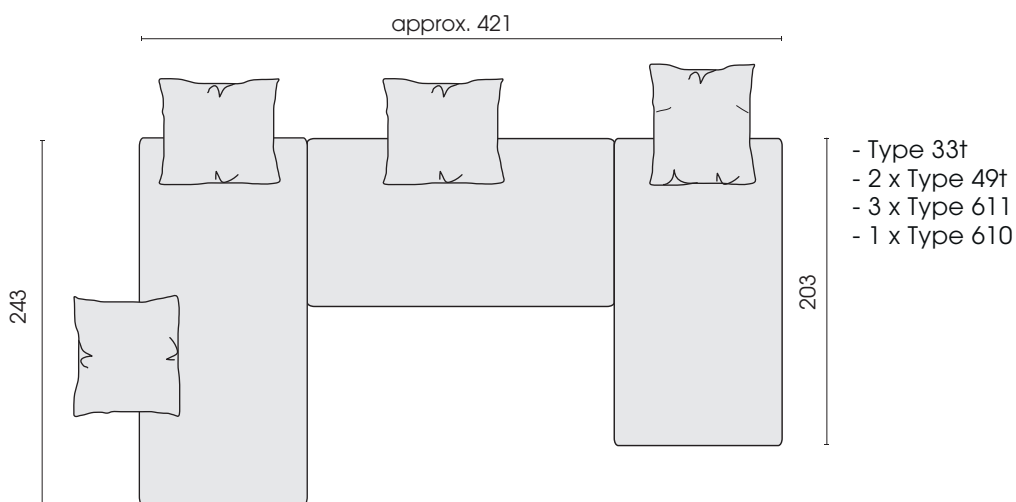

- Type 33t
- 2 x Type 49t
- 3 x Type 611
- 1 x Type 610

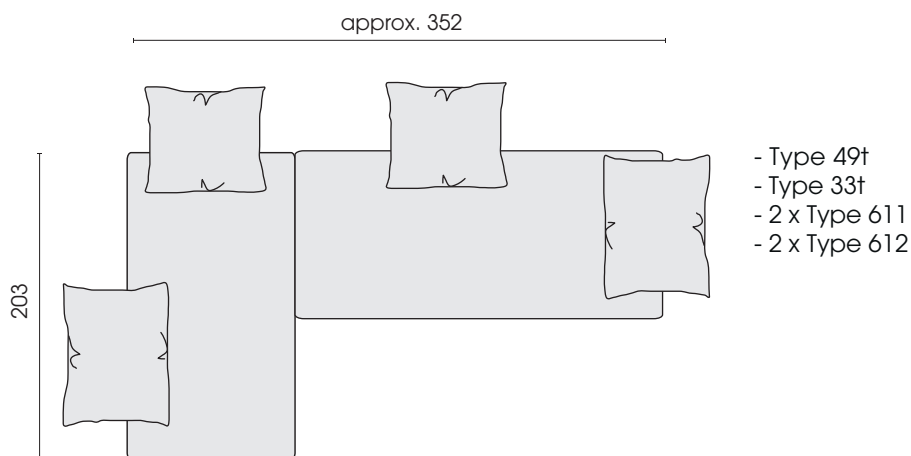

- Type 49t
- Type 33t
- 2 x Type 611
- 2 x Type 612

Each piece of furniture is handmade and unique. Deviations to the listed measurements may be caused by:
 1. different upholstery materials (fabric, leather), 2. processing of ticking mats, 3. the pressure to combine individual parts, etc.
 The seat comfort of a sofa type with larger seat depth usually differs from one with lower depth.

Combinations

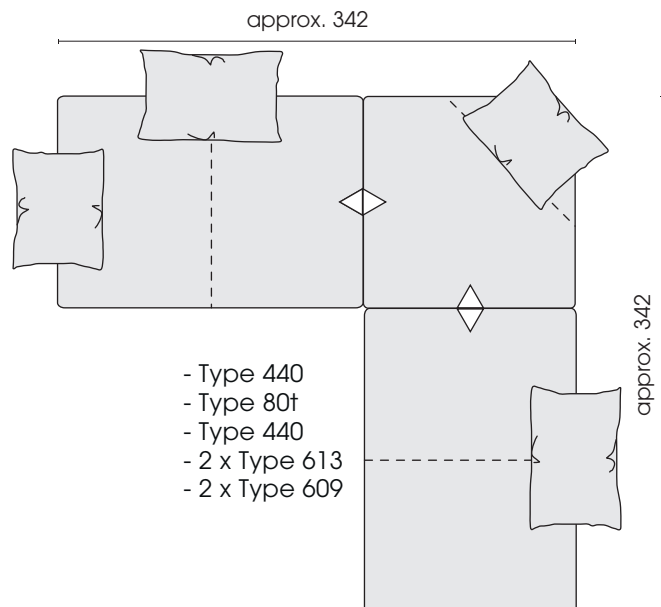
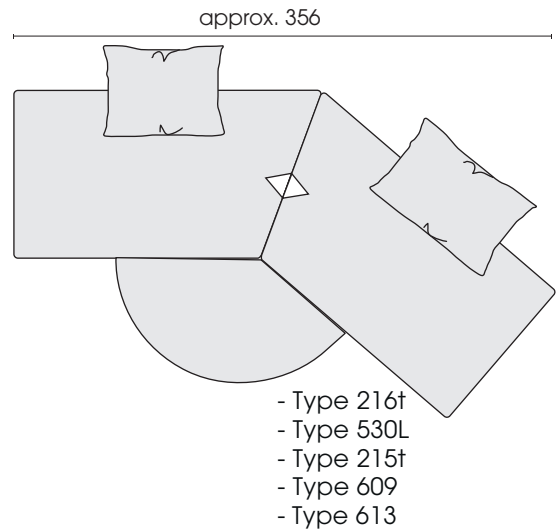
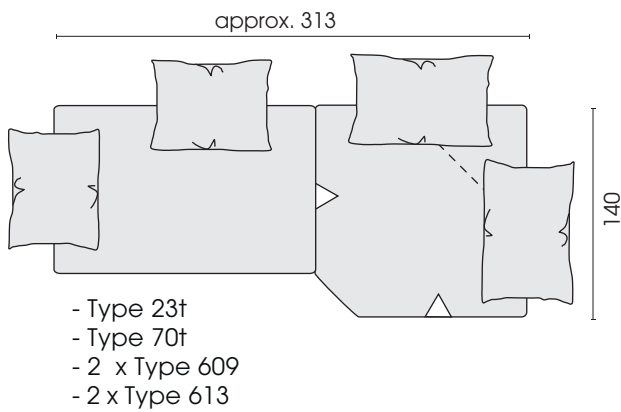
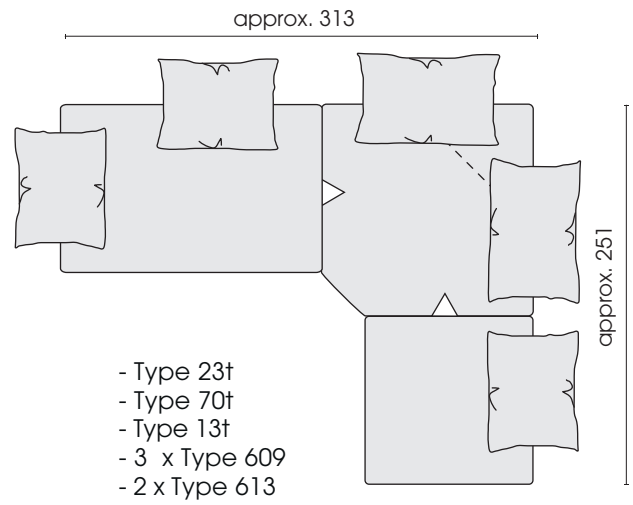
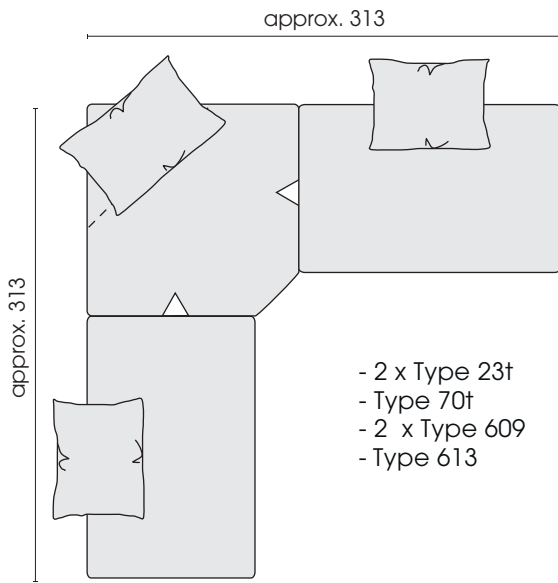

Each piece of furniture is handmade and unique. Deviations to the listed measurements may be caused by:
 1. different upholstery materials (fabric, leather), 2. processing of ticking mats, 3. the pressure to combine individual parts, etc.
 The seat comfort of a sofa type with larger seat depth usually differs from one with lower depth.