

PRODUCT INFORMATION MODEL 0221 WUMMS!

© 2021 KURT BEIER & KATI QUINGER



Type 62T

Type 61T



Type 258

Type 61TF



Big sofa on a covered plateau



Optionally with motorised seat adjustment



Luxurious with comfortable spring core











Loosely inserted seat cushions

WUMMS!: LUX LOUNGE - A DREAM OF FREEDOM - GENEROUS AND LUXURIOUS! A MASTERPIECE FOR THE LIVING ROOM. SIT WITH PLEASURE, LIE DOWN AND CHILL. THE MATERIALS SELECTED FOR THE BEST COMFORT. CUSTOMIZE YOUR SOFA WITH LEATHER OR FABRIC. AS WELL AS THE NUMBER AND SIZE OF THE CUSHIONS. USE OUR VARIETY OF PLAIN AND PATTERNED FABRICS. WUMMS! - A REAL BULLFROG. UNIQUE PIECE PRODUCTION.

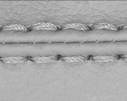

Feet: angle steel feet, black matt fine structure powder-coated , 10 cm
Floor distance: ca. 10 cm

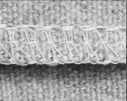
Processing options of main seam / decorative seam

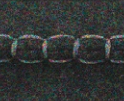
	Plain seam	Lap seam	Raw edged	Moccasin seam extra charge	Twin seam extra charge	KR* (zipper piping) extra charge	Overcast seam extra charge	Piping	Two needle seam	Square seam extra charge
										
Fabric	x									
Leather		x	x							
Fur										

It is possible to order main seam or decorative seam either tone in tone like the colours of cover or in the contrasting colours white, nature, grey, rust and black. On request special colours possible.

*Zipper piping: optionally in the colours black, red, nature or light grey.

Standard version for motorised drive:

- wireless remote control
- power supply

Optionally with battery for an extra charge.

14.09.2022

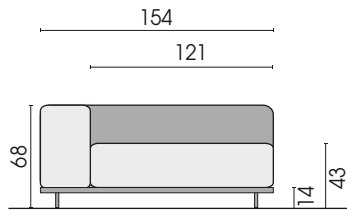

Front view

▷ = Connector side

◻ = Label

Single elements, deep

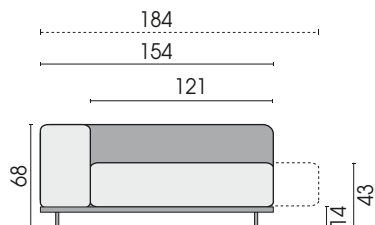
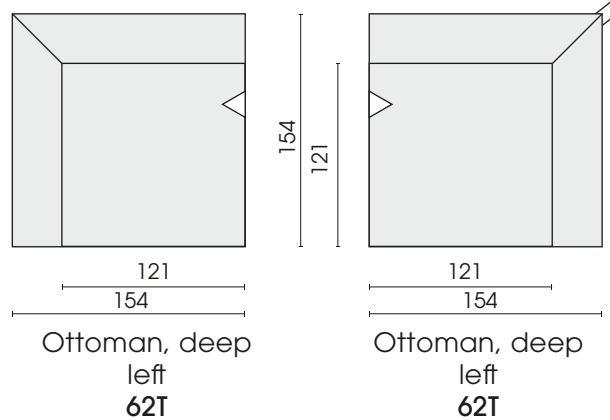

Side view

▷ = Connector side

◻ = Label

Single elements with motorised seat adjustment, deep

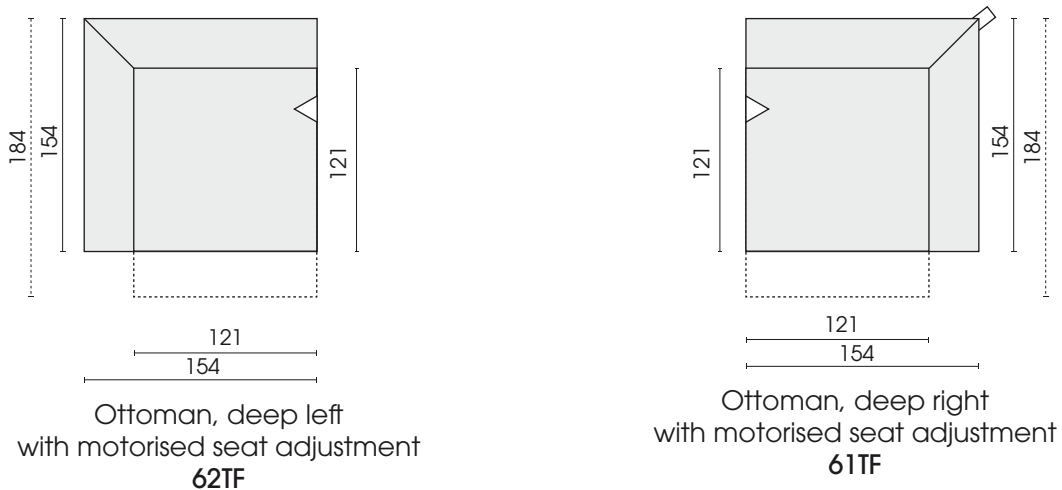

Each piece of furniture is handmade and unique. Deviations to the listed measurements may be caused by:

1. different upholstery materials (fabric, leather),
2. processing of ticking mats,
3. the pressure to combine individual parts, etc.

The seat comfort of a sofa type with larger seat depth usually differs from one with lower depth.

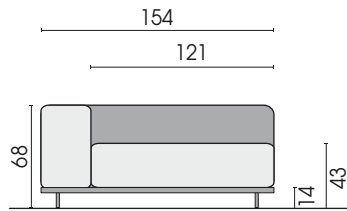

Front view

▷ = Connector side

□ = Label

Single elements

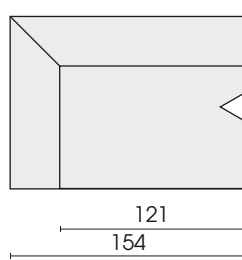

Sofa 2-seat,
armrest left
220

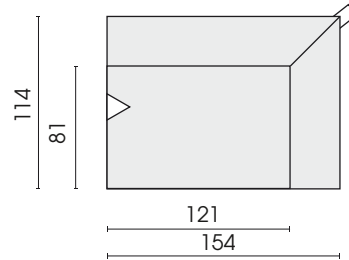

Sofa 2-seat,
armrest right
210

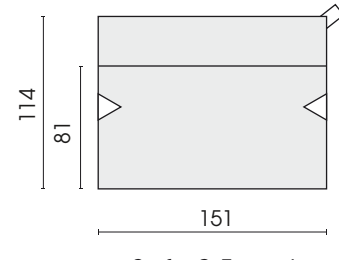

Sofa 2,5-seat,
withour armrest
249

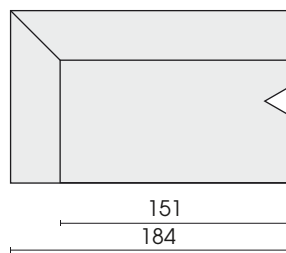

Sofa 2,5-seat,
armrest, left
258

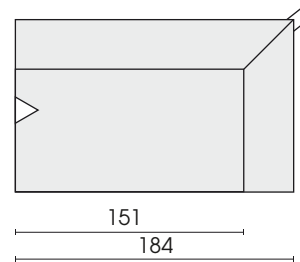

Sofa 2,5-seat,
armrest, right
257

Cushions

Cushions with decorative seams are either tone in tone or contrasting colour possible.

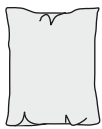

Funkli S

Functional cushion
(tapered cushion)
(plain seam)
(Leather: raw edged)
62 x 78
582



Funkli

Functional cushion
(with dart)
(plain seam)
62 x 78
586

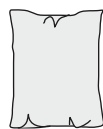

Funkli S

Functional cushion
(tapered cushion)
(decorative overcast seam)
62 x 78
589



Cushion

(tapered cushion)
(plain seam)
78 x 58
902



Cushion

(tapered cushion)
(plain seam)
72 x 72
904



Cocu

Triangle cushion
(Fabric: plain seam)
65 cm
906



Cushion

(tapered cushion)
(plain seam)
38 x 38
950



Cushion

(throw cushion)
(plain seam)
70 x 60
955



Cushion

(tapered cushion)
KF (tassels, piping)
(plain seam)
60 x 40
967KF



Cushion

(tapered cushion)
(plain seam)
60 x 40
967



Cushion

(with dart)
(Fabric: plain seam)
(Leather: lap seam)
50 x 50
972



Cushion

(with dart)
(Fabric: plain seam)
(Leder: lap seam)
58 x 58
973

Each piece of furniture is handmade and unique. Deviations to the listed measurements may be caused by:

1. different upholstery materials (fabric, leather), 2. processing of ticking mats, 3. the pressure to combine individual parts, etc.
- The seat comfort of a sofa type with larger seat depth usually differs from one with lower depth.

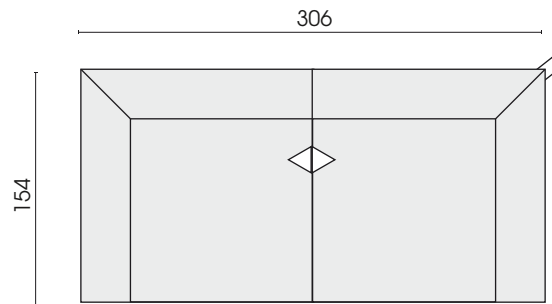

- Type 62T
- Type 61T

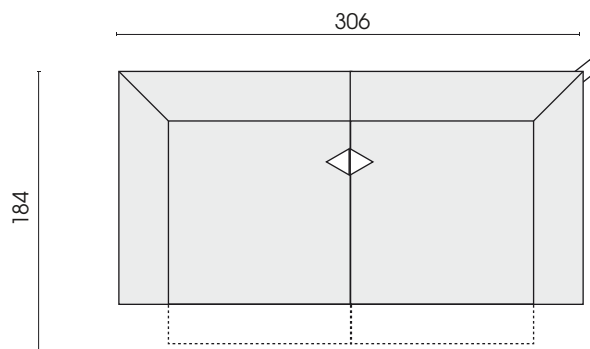

- Type 62TF
- Type 61TF

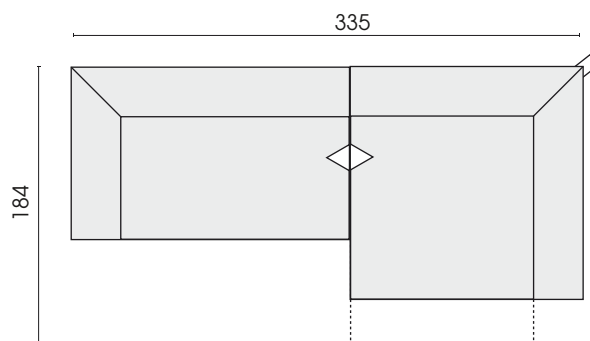

- Type 258
- Type 61TF

Each piece of furniture is handmade and unique. Deviations to the listed measurements may be caused by:
1. different upholstery materials (fabric, leather), 2. processing of ticking mats, 3. the pressure to combine individual parts, etc.
The seat comfort of a sofa type with larger seat depth usually differs from one with lower depth.