

Fusto in legno massello e legno multistrato con cinghie elastiche intrecciate. Imbottitura in poliuretano espanso rivestito in vellutino bianco. Cuscini di schienale in Piumafib, una speciale miscela ipoallergenica di vera piuma e fibra poliestere siliconata\*.

Cuscini di seduta costituiti da un inserto in poliuretano con densità di 30 Kg/m<sup>3</sup> ricoperto da un trapuntino di vera piuma imbottito a scomparti\*. Completamente sfoderabile in tessuto, non sfoderabile in pelle e finta pelle. Kit letto disponibile.

Disponibile anche nella versione con cuscini di seduta e schienale trapuntati  
\* Manutenzione dei cuscini contenenti piuma: I cuscini contenenti piuma tendono a deformarsi con l'utilizzo.

Per mantenerne la forma è necessario, anche dopo un breve utilizzo, battere e sprimacciare ripetutamente i cuscini. Non utilizzare mai battipanni o aspirapolvere. A coloro che non desiderassero seguire queste indicazioni o che volessero un divano dall'aspetto meno vissuto, raccomandiamo di preferire dei cuscini in gomma.

*Frame made of solid wood and multi-ply wood with interwoven elastic straps. The upholstery is made of polyurethane foam, covered with dacron. The back cushions are filled with Piumafib, a special hypoallergenic mixture of feathers and siliconised polyfibre\*.*

*The seat cushions are made of a foam insert with density of 30 Kg/m<sup>3</sup>, covered with a feather compartments quilt\*. Fully removable fabric covers, fixed leather and artificial leather covers. Sofa-bed is available.*

*Available also with quilted seat and back cushions. \* Maintenance of feather cushions: Cushions filled with feathers tend to change their shape with use.*

*In order to keep their shape it is necessary, even after a short use, to plump up the cushions repeatedly. Never use carpet beater or vacuum cleaner. We recommend to choose foam cushions to those who do not wish to follow these instructions or to have a "used look" sofa.*

*Das Gestell besteht aus Massiv- und Schichtholz, mit geflochtenen Gummigurten, gepolstert mit Polyurethanschaumstoff, mit Dacron bezogen. Rueckenkissen aus Piumafib, einer hypoallergischen speziellen Mischung aus echter Daune und silikonisierter Polyesterfaser\*. Die Sitzkissen bestehen aus einem Schaumkern mit Dichte 30 Kg/m<sup>3</sup> mit einer gekammerten Daunenauflege\*.*

*Stoffbezüge alle abziehbar, Leder und Kunstleder festbezogen. Als Bettsofa verfügbare. Verfügbare auch mit abgesteppten Sitz- und Rueckenkissen.*

*\* Wartungsanleitungen fuer Daunenkissen: Die Kissen, die Daunen enthalten, neigen dazu, sich durch Gebrauch zu verformen.*























*Um die urspruengliche Form zu halten, ist es notwendig, auch nach kurzem Gebrauch, die Kissen wiederholt aufzuschuettern. Keinen Auskloepfer oder Staubsauger verwenden. Unseren Kunden, die diese Anweisungen nicht befolgen moechten, oder die kein Sofa mit solchem "gebrauchten" Aussehen haben moechten, empfehlen wir Polyurethan-Kissen.*

*Для производства каркаса используется массив дерева и многослойная фанера в сочетании с перекрещивающимися эластичными ремнями. Наполнение из полиуретана, обернутого в белый бархат. Наполнение подушек спинки выполнено из материала Piumafib – специальной, не вызывающей аллергии смеси из натурального пуха и полиэфирных силиконовых волокон\*. Подушки сиденья: стеганые по отсекам, наполнение из натурального пуха с вставками из полиуретана плотностью 30 кг/м<sup>3</sup> \*. Полностью съемные чехлы из ткани, несъемные чехлы из кожи.*

*Исполнение дивана в версии со спальным местом: возможно Также возможно изготовление подушек сиденья и спинки с декоративной прострочкой \* Эксплуатация подушек с пуховым наполнением: В процессе эксплуатации подушки с пуховым наполнением могут деформироваться, во избежание чего их необходимо слегка взбивать вручную даже после непродолжительного нахождения на диване. Использование в этих целях пылесоса или выбивалки для одежды категорически запрещено. Если клиент не планирует следовать данным инструкциям и хочет, чтобы подушки сиденья и спинки проминались по минимуму, посоветуйте выбрать наполнение только из полиуретана, полностью исключив натуральный пух.*

*Carcasse en bois massif et multiplis muni de bandes élastiques entrecroisées et finie de mousse polyuréthane couverte de dacron. Coussins de dossier en Piumafib, un mélange hypoallergénique spécial de véritable duvet et fibre polyester siliconisée\*. Les coussins d'assise sont composés d'un noyau en mousse polyuréthane d'une densité de 30 kg/m<sup>3</sup> couvert de véritable duvet matelassé en compartiments\*. Revêtement complètement déhoussable en tissu, fixe en cuir et cuir look. Disponible en canapé-lit. Également disponible avec les coussins d'assise et de dossier matelassés. \* Entretien de coussins en duvet: Coussins en duvet ont tendance à perdre leur forme dû à l'usage. Pour en conserver la forme il est nécessaire, aussi après un usage court, de régulièrement battre les coussins. Ne jamais utiliser la tapette ou l'aspirateur. À ceux qui ne désirent pas suivre ces indications ou qui souhaitent un canapé qui ait l'air moins "usé", nous conseillons vivement de choisir des coussins en mousse polyuréthane.*

## Finiture Finishes

Piedini in metallo Versione A Metal feet version A																			
Code	Shiny chrome metal <b>OPM1</b>	Brushed matt chrome metal <b>OPM2</b>	Brushed matt dark grey metal <b>OPM3</b>	RAL 9017 traffic black painted metal <b>OPM6</b>	Classic bronze painted metal <b>OPM9</b>	Brushed copper metal <b>OPM12</b>													
																			
Code	Brushed antique brass metal <b>OPM13</b>	Shiny black chrome metal <b>OPM14</b>	Brushed antique gold metal <b>OPM15</b>	Shiny brass chrome metal <b>OPM16</b>	Bronze metal <b>OPM17</b>	Anodized bronze metal <b>OPM18</b>													
Piedini in legno Versione B Wooden feet version B																			
Code	Cherry stained beech <b>OPF1</b>	Wengé stained beech <b>OPF2</b>	Walnut stained beech <b>OPF3</b>	Natural beech <b>OPF4</b>	Black stained beech <b>OPF5</b>	Cherry Milano stained beech <b>OPF6</b>	Tobacco stained beech <b>OPF8</b>	Grey taupe stained beech <b>OPF9</b>	Charcoal stained beech <b>OPF11</b>	Mahogany stained beech <b>OPF12</b>									

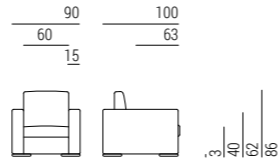

Divani  
Sofas

Elementi componibili  
Modular elements















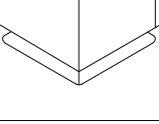
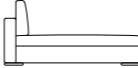

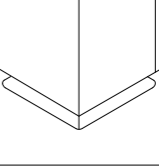
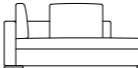

Divani letto  
Sofa-beds

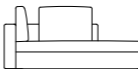
 <b>9G0101</b> L90 P100 H86	 <b>9G0301</b> L115 P100 H86	<p>Elemento angolare Corner element</p>  <b>9G0207</b> L100 P100 H86	 <b>9G0213</b> L190 P100 H86	 Materasso Mattress L115 P190 H15
 <b>9G0202</b> L170 P100 H86	 <b>9G0302</b> L135 P100 H86	<p>Elemento angolare Corner element</p>  <b>9G0208</b> L125 P100 H86	 <b>9G0214</b> L210 P100 H86	 Materasso Mattress L145 P190 H15
 <b>9G0203</b> L190 P100 H86	 <b>9G0303</b> L155 P100 H86	 <b>9G0402</b> L140 P100 H86	 <b>9G0215</b> L230 P100 H86	 Materasso Mattress L160 P190 H15
 <b>9G0204</b> L210 P100 H86	 <b>9G0304</b> L175 P100 H86	 <b>9G0403</b> L160 P100 H86	 <b>9G0216</b> L250 P100 H86	 Materasso Mattress L160 P190 H15
 <b>9G0205</b> L230 P100 H86	 <b>9G0305</b> L195 P100 H86	 <b>9G0404</b> L180 P100 H86	 <b>9G0314</b> L175 P100 H86	 Materasso Mattress L115 P190 H15
 <b>9G0206</b> L250 P100 H86	 <b>9G0306</b> L215 P100 H86	 <b>9G0405</b> L200 P100 H86	 <b>9G0315</b> L195 P100 H86	 Materasso Mattress L145 P190 H15
			 <b>9G0316</b> L215 P100 H86	 Materasso Mattress L160 P190 H15

Dormeuse  
Longchair

Pouf e accessori  
Pouf and accessories

Piedini  
Feet

 <b>9G0102</b> L180 P98 H86	 80	 <b>9G0110</b> L100 P75 H40	 <b>9G0112</b> L100 P125 H40	 Versione A (standard) in metallo Version A (standard) in metal H 3 cm
 <b>9G0103</b> L180 P98 H86	 80	 <b>9G0111</b> L100 P100 H40		 Versione B in legno Version B in wood H 3 cm
 <b>9G0104</b> L200 P98 H86	 55	 <b>9CU103</b> L40 H40 Cuscinetto in piuma senza fascia Feather cushion without band	 <b>9CUT104</b> L60 H60 Cuscinetto trapuntato in piuma senza fascia Quilted feather cushion without band	
 <b>9G0105</b> L200 P98 H86	 80	 <b>9CU105</b> L50 H50 Cuscinetto in piuma senza fascia Feather cushion without band	 <b>9G0107</b> L45 H45 Cuscinetto in piuma con fascia Feather cushion with band	
 <b>9G0106</b> L225 P98 H86	 45	 <b>9CU103</b> L40 H40 Cuscinetto trapuntato in piuma senza fascia Quilted feather cushion without band	 <b>9G0109</b> L80 H40 Cuscinetto in piuma con fascia Feather cushion with band	

Divani  
Sofas

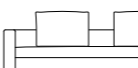
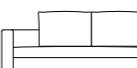
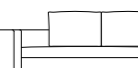
 <b>9G0406</b> L245 P105 H86	 <b>9G0407</b> L187 P105 H86	 <b>9G0408</b> L213 P150 H86
---	---	---

# Gordon Round

# Gordon Move

DESIGN  
STUDIO MARELLI  
2014

Movimento schienali  
Backrest mechanism

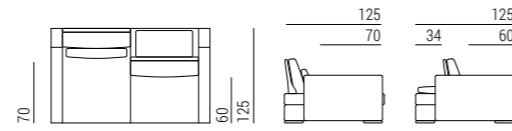

384

LIFESTYLE COLLECTION 2021 \_ MARELLI

Divani  
Sofas

Elementi componibili  
Modular elements

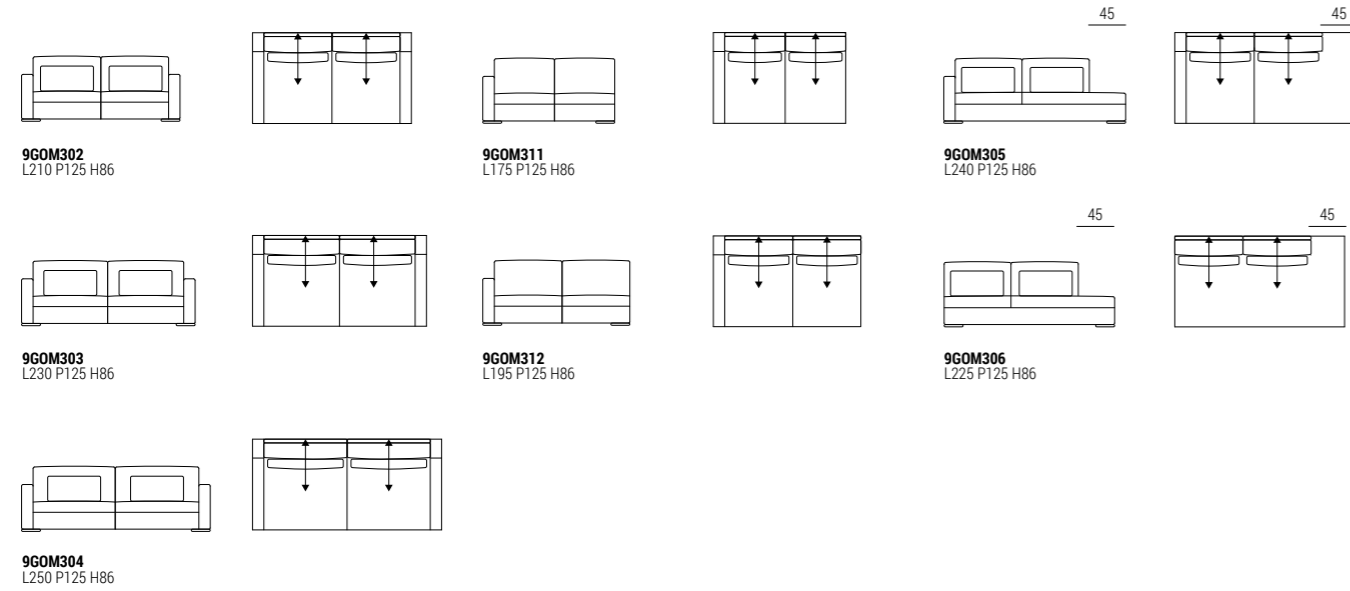

Gli elementi componibili Gordon Move possono essere liberamente combinati con gli elementi Gordon per creare infinite composizioni

The different elements of Gordon Move can be combined with the modular elements of Gordon to create several and different compositions

# Gordon Move

DESIGN  
STUDIO MARELLI  
2014

385

LIFESTYLE COLLECTION 2021 \_ MARELLI

Pouf e accessori  
Pouf and accessories

Piedini  
Feet

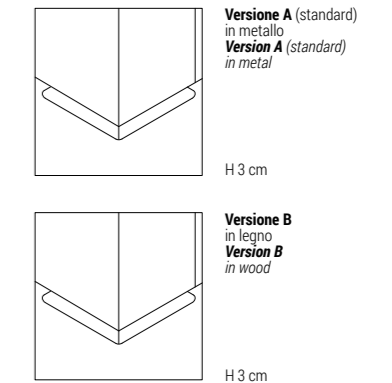
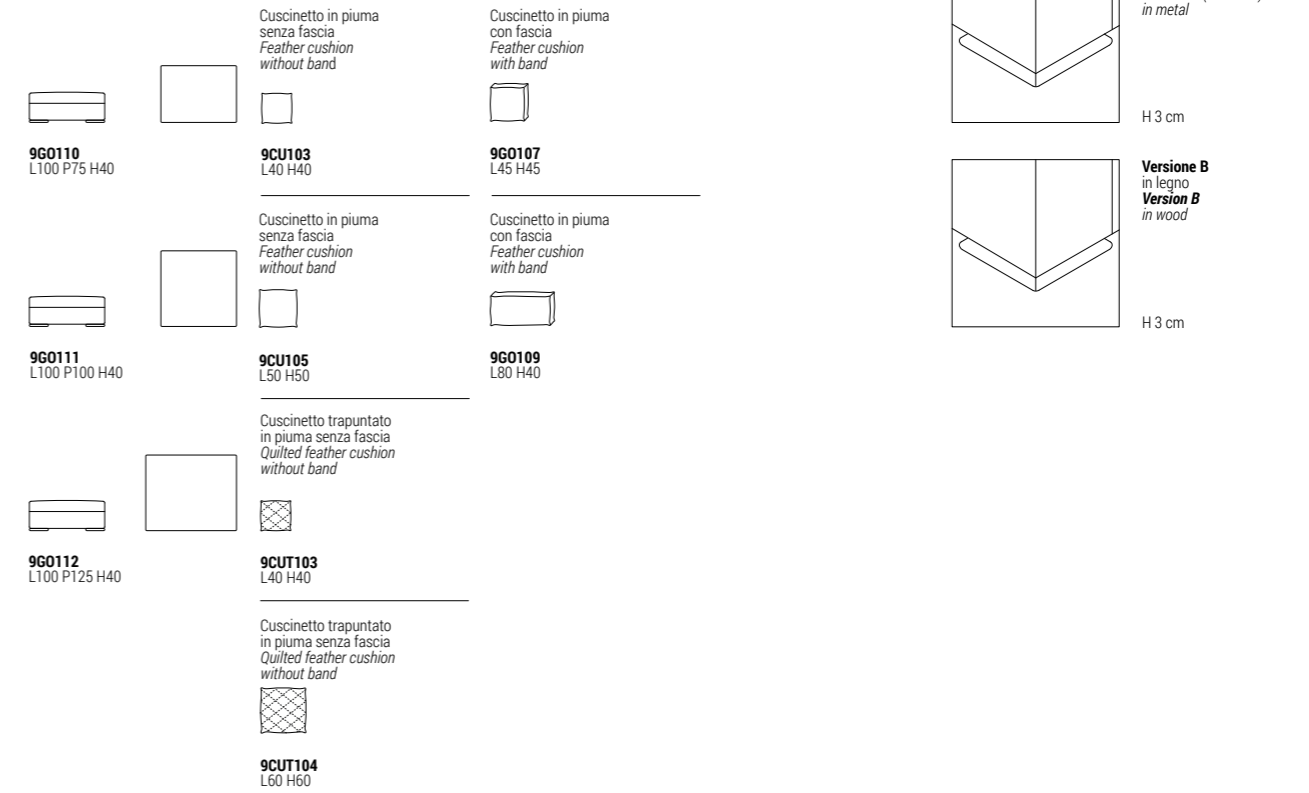

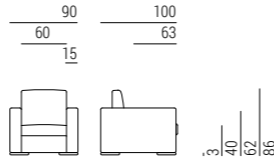

Divani  
Sofas

Elementi componibili  
Modular elements

Divani letto  
Sofa-beds



Dormeuse  
Longchair

Pouf e accessori  
Pouf and accessories

Piedini  
Feet

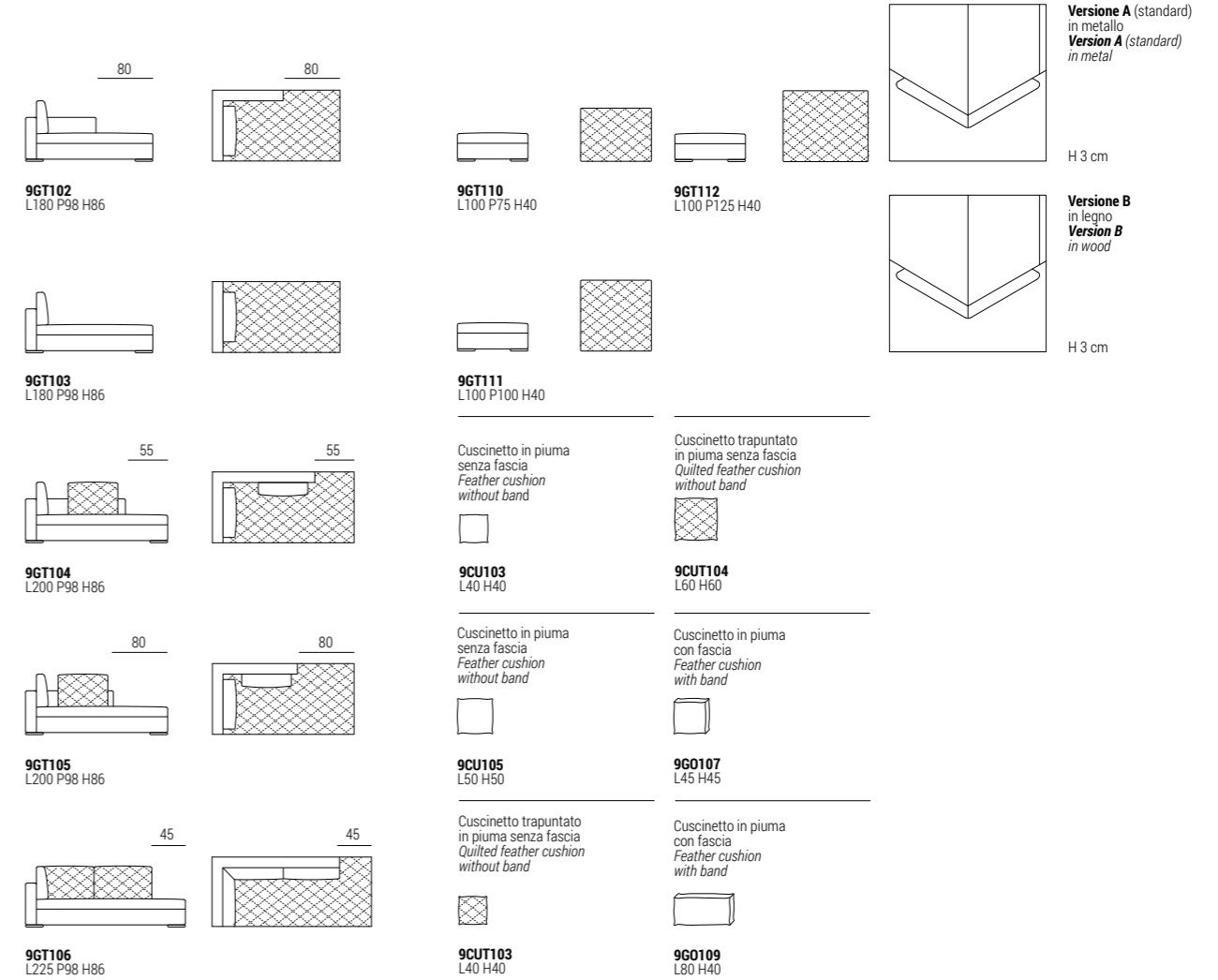

Divani  
Sofas

# Gordon Round Quilted

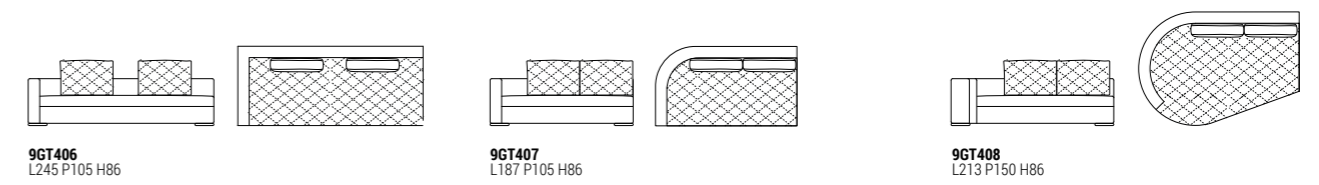

# Gordon Move Quilted

DESIGN  
STUDIO MARELLI  
2014

Movimento schienali  
Backrest mechanism

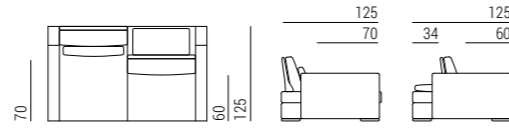

# Gordon Move Quilted

DESIGN  
STUDIO MARELLI  
2014

388

LIFESTYLE COLLECTION 2021 \_ MARELLI

Divani  
Sofas

Elementi componibili  
Modular elements

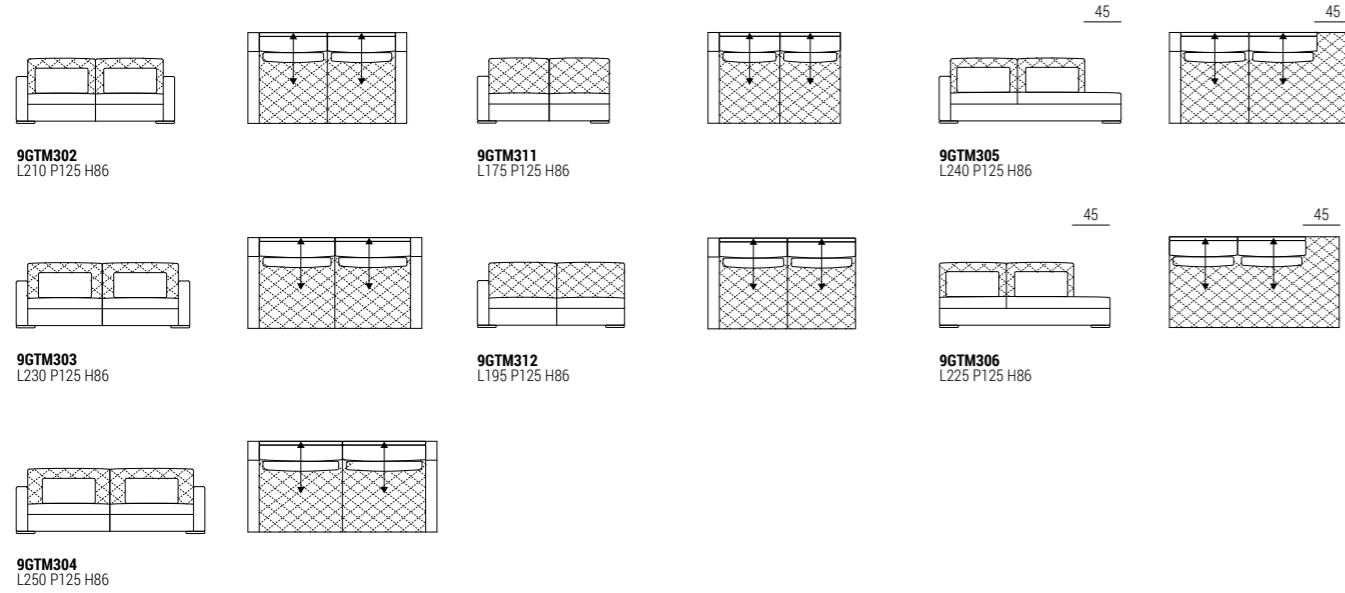

Pouf e accessori  
Pouf and accessories

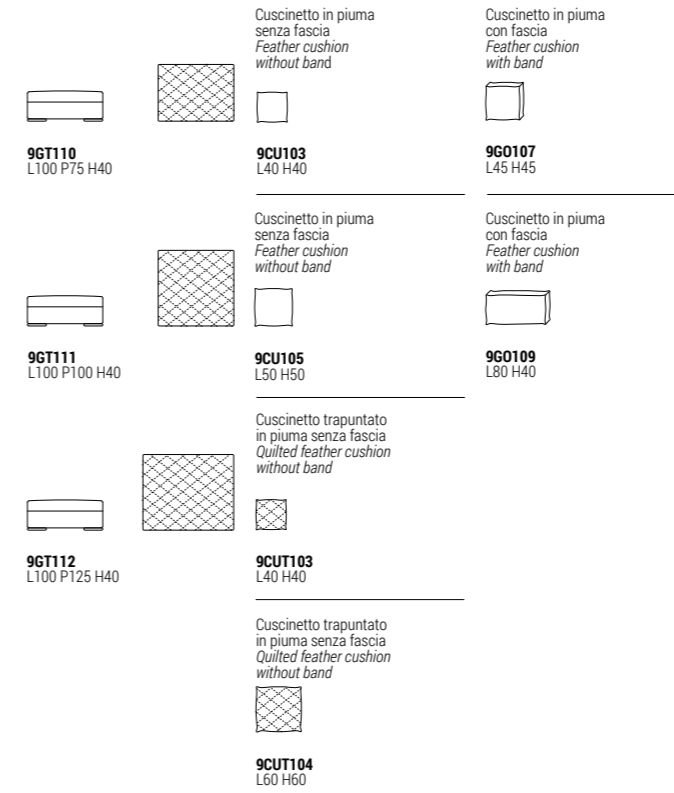

Piedini  
Feet

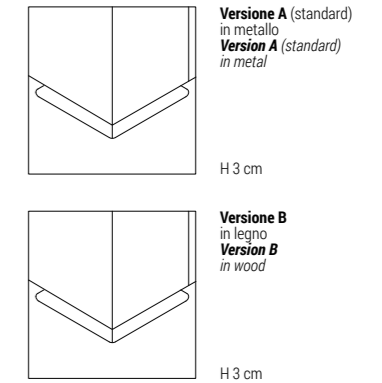

Gli elementi componibili Gordon Move possono essere liberamente combinati con gli elementi Gordon per creare infinite composizioni

The different elements of Gordon Move can be combined with the modular elements of Gordon to create several and different compositions

389

LIFESTYLE COLLECTION 2021 \_ MARELLI