

# PRODUCT INFORMATION MODEL 2308 BALOU

© 2023 KURT BEIER & KATI QUINGER



Functional backrest,  
manually adjustable



Stool, usable as sofa element



Super soft sitting comfort







**BALOU: THE LUXURY RENDEZVOUS**

THE LUXURIOUS DESIGN ELEMENTS OF OUR BULLFROG COLLECTION ALLOW WONDERFUL CUSTOM CONFIGURATIONS. ELEMENTS WITH FLEXIBLE BACK AND ARM SECTIONS AND A LOOSE-FITTING SEAT CUSHION, ALL IN SUPERSOFT COMFORT. THE RICH SELECTION OF TEXTILES AND LEATHERS OFFER MANY POSSIBILITIES FOR INDIVIDUAL DESIGN. UNIQUE PIECE PRODUCTION.

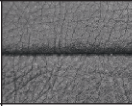
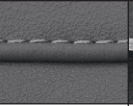
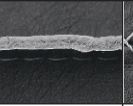

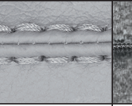
Plastic glides: Height: 6 cm / Floor distance: 6 cm

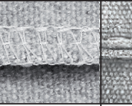
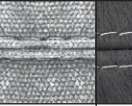
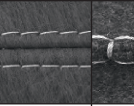
**Processing options of main seam / decorative seam**

	Plain seam	Lap seam	Raw edged	Moccasin seam extra charge	Twin seam extra charge	KR* (zipper piping) extra charge	Overcast seam extra charge	Piping	Two needle seam	Square seam extra charge
										
Fabric	x									
Leather	x									
Fake fur										

It is possible to order main seam or decorative seam either tone in tone like the colours of cover or in the contrasting colours white, nature, grey, rust and black. On request special colours possible.

\***Zipper piping:** optionally in the colours black, red, nature or light grey.



23.03.2026

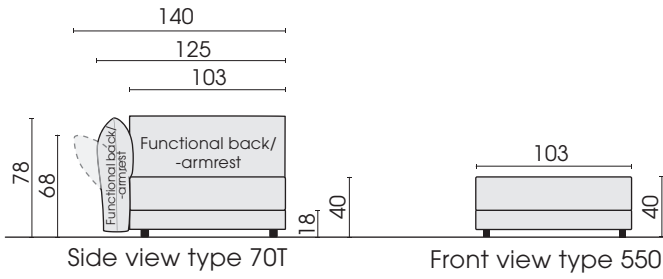

▷ = Connector side

## Elements

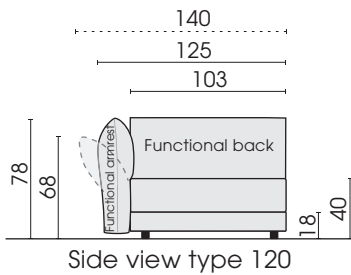
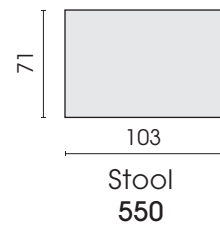
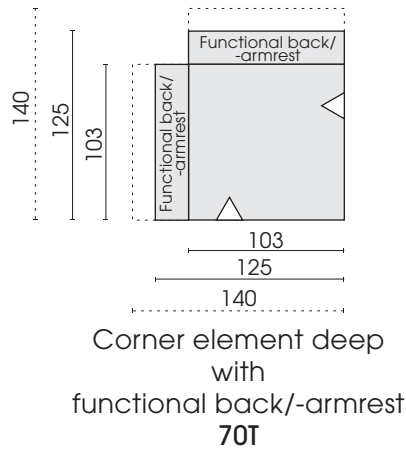
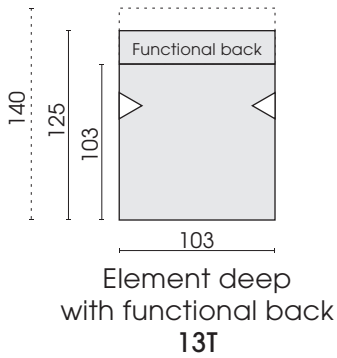

▷ = Connector side

## Elements

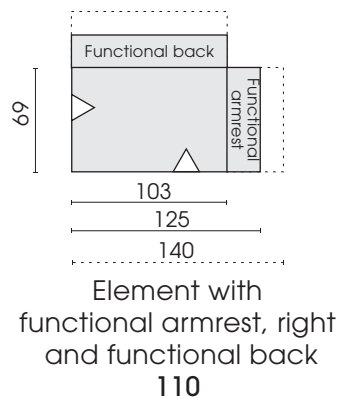
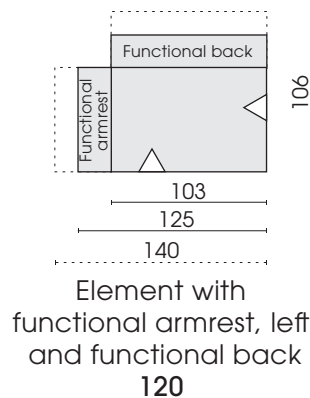
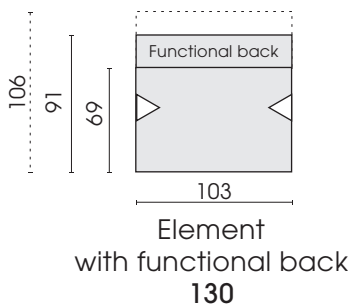

Each piece of furniture is handmade and unique. Deviations to the listed measurements may be caused by:  
1. different upholstery materials (fabric, leather), 2. processing of ticking mats, 3. the pressure to combine individual parts, etc.  
The seat comfort of a sofa type with larger seat depth usually differs from one with lower depth.



Cushion  
(plain seam)  
ø 50  
**931**



Cushion  
(tapered cushion)  
(plain seam)  
78 x 60  
**949**



Cushion  
(tapered cushion)  
(plain seam)  
60 x 40  
**967**

**Combinations**

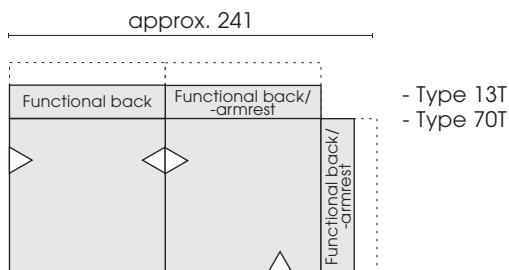
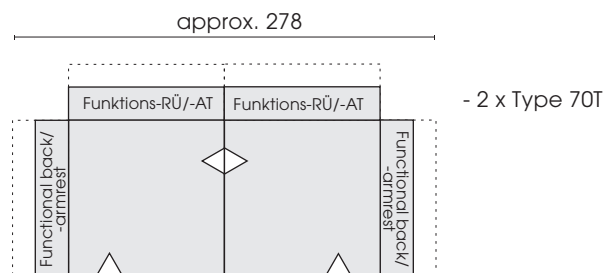
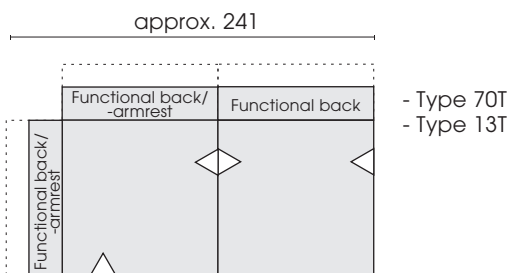
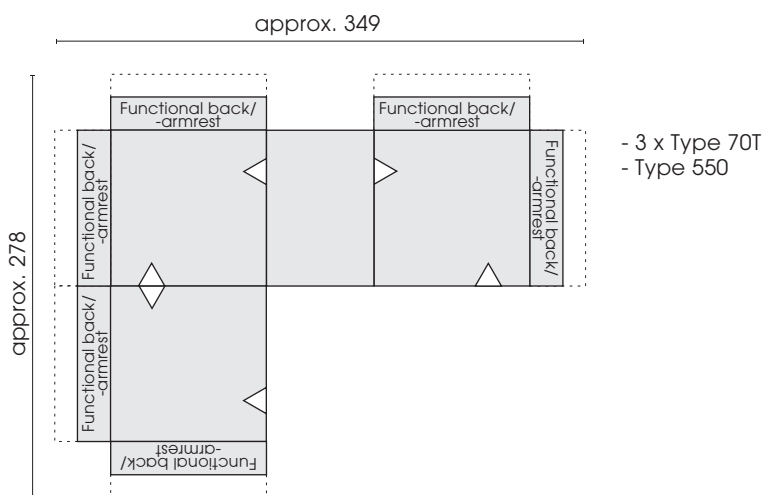

Each piece of furniture is handmade and unique. Deviations to the listed measurements may be caused by:  
1. different upholstery materials (fabric, leather), 2. processing of ticking mats, 3. the pressure to combine individual parts, etc.  
The seat comfort of a sofa type with larger seat depth usually differs from one with lower depth.

Combinations

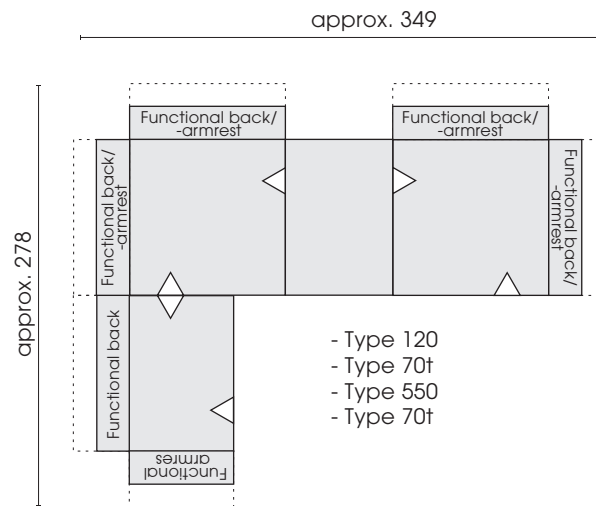
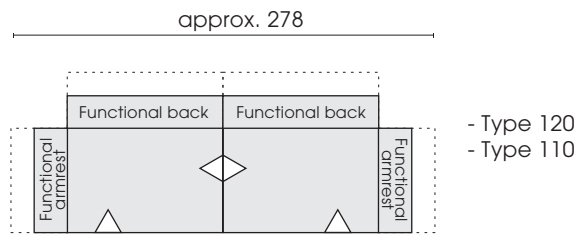

Each piece of furniture is handmade and unique. Deviations to the listed measurements may be caused by:  
 1. different upholstery materials (fabric, leather), 2. processing of ticking mats, 3. the pressure to combine individual parts, etc.  
 The seat comfort of a sofa type with larger seat depth usually differs from one with lower depth.