

PRODUCT INFORMATION MODEL OD1037 LETTINO

© 2011 KURT BEIER & KATI QUINGER



www.bullfrog-design.com

Loungers Lettino with intermediate table



Functional lounge Lettino, single or...



...as comfort double lounge



Lettino Twist with swivel function and practical concrete table



Flexibility due to practical castors

OD LETTINO: FLOAT ON A CLOUD. OUTDOOR GARDEN LOUNGER WITH SOFT UPHOLSTERY ON A LIGHT, HIGH-QUALITY STAINLESS STEEL BASE FRAME. HEAD AND FOOT SECTIONS OF THE LOUNGER CAN BE ADJUSTED TO HORIZONTAL POSITION IN SEVERAL STEPS. LARGE CASTORS ON THE BASE FRAME ENSURE MOBILITY. UNIQUE PIECE PRODUCTION.

OD LETTINO TWIST - FUNNY FOR SUNNY. THE SUN LOUNGER WITH THE ROTATION OF 90 DEGREES WILL ALWAYS ACHIEVE YOUR DESIRED POSITION AND THE TABLE NEXT TO IT IS THE PERFECT STORAGE SOLUTION FOR THE NEEDS OUTSIDE. UNIQUE PIECE PRODUCTION.



Base frame with castors: Optionally stainless steel square tube with grey castors or black matt fine structure powder-coated metal square tube with black castors.



Type 224

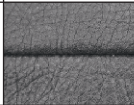
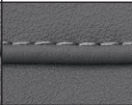

Type 224FD

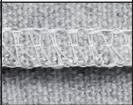
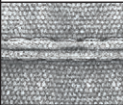
Processing options of main seam / decorative seam					
	Plain seam	Lap seam	KR* (zipper piping) Extra charge	Overcast seam Extra charge	Piping
					
Outdoor fabric	x				x
Outdoor leather	x				

*Zipper piping: optionally in the colours black, red, nature or light grey.

Outdoor innercover

Additional protection against moisture penetration is provided by an inner cover made of waterproof fabric. The inner cover can be selected for the respective model at an extra charge.

Please specify when ordering.

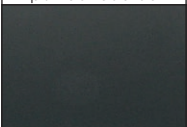
Table top 859 for lounge 224:	Table tops for type 224FD:	Our concrete table tops are made of poured concrete. Their low material thickness with high stability is achieved by a glass fibre reinforcement. The concrete table top is coloured throughout and the surface is oiled. Due to the open structure, colour shading may occur on the surface. The table top is light, UV and weather resistant.
	Concrete Oiled	
Metal, black matt fine structure powder-coated		
	✓	

10.02.2026

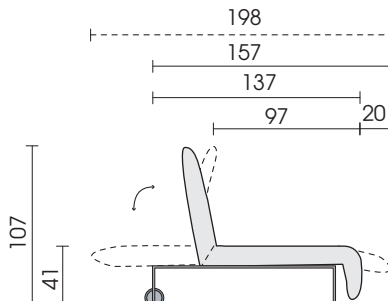

Side view type 224

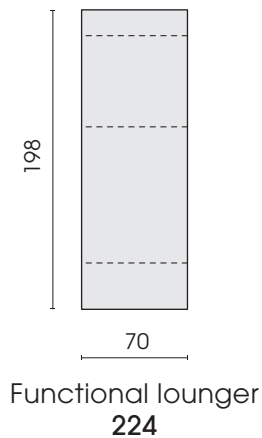

Functional lounger
224

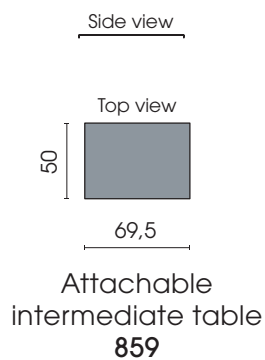

Attachable
intermediate table
859

2 connector clips
VB1

A combination with an intermediate table or a fixation with connector clips is only possible with functional lounger type 224.

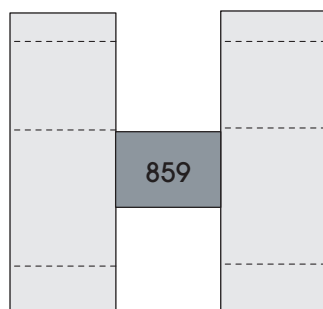

Combination with
2 x 224 + table 859

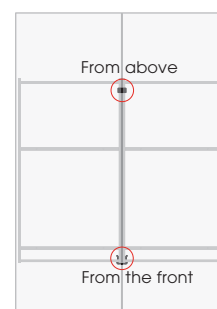

Fixation with
2 connector clips (VB1)

Each piece of furniture is handmade and unique. Deviations to the listed measurements may be caused by:
1. different upholstery materials (fabric, leather), 2. processing of ticking mats, 3. the pressure to combine individual parts, etc.
The seat comfort of a sofa type with larger seat depth usually differs from one with lower depth.

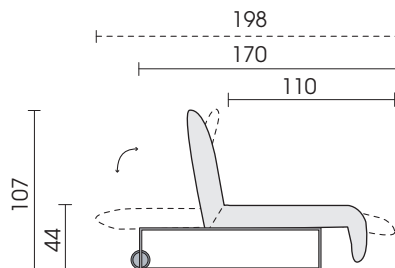

Side view type 224FD

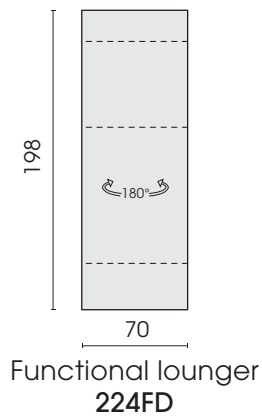

Functional lounger
224FD

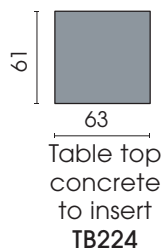

Table top
concrete
to insert
TB224

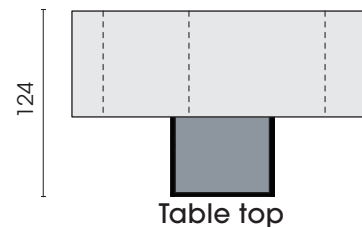

Table top

Protective cover (waterproof):
Protective cover for type 224/224FD: SH224

Each piece of furniture is handmade and unique. Deviations to the listed measurements may be caused by:
1. different upholstery materials (fabric, leather), 2. processing of ticking mats, 3. the pressure to combine individual parts, etc.
The seat comfort of a sofa type with larger seat depth usually differs from one with lower depth.