

PRODUCT INFORMATION MODEL 6011 LEA

© 2013 KURT BEIER & KATI QUINGER

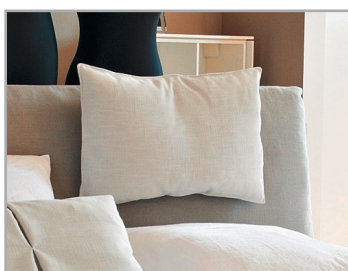

AS AN ADDITIONAL OPTION
A HANG OVER CUSHION



SLIP COVER WITH ZIPPER









SLIP COVER WITH BOX PLEAT

LEA: THE COMFORTABLE SLEEPING PROGRAMME WITH REPLACEMENT COVER IN 2 VARIATIONS - EITHER WITH BOX PLEAT OR WITH ZIPPER. THE COMFORTABLE BACK IS PADDED WITH HIGH-QUALITY DOWN TICKING AT THE FRONT. THE INSERT DEPTH OF SLATTED FRAME IS ADJUSTABLE, THUS THE HEIGHT OF MATTRESS CAN BE ADJUSTED INDIVIDUAL. THIS BED IS ALSO SUITABLE FOR BOX SPRING SYSTEMS.

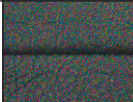
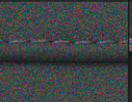
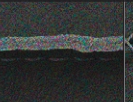
Insert depth for slatted frame: approx. 12,5-22 cm
 Insert depth for box spring frame: approx. 21,5-31 cm
 (measured from top edge of foot part)

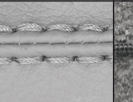

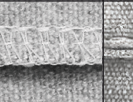
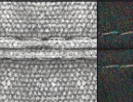
Processing options of main seam / decorative seam

	Plain seam	Lap seam	Raw edged	Moccasin seam extra charge	Twin seam extra charge	KR* (zipper piping) extra charge	Overcast seam extra charge	Piping	Two needle seam	Square seam extra charge
										
Fabric								x		
Leather										

It is possible to order main seam or decorative seam either tone in tone like the colours of cover or in the contrasting colours white, nature, grey, rust and black. On request special colours possible.

*Zipper piping: optionally in the colours black, red, nature or light grey.

Slip cover bed with *box pleat*

Processing options				
	Plain seam	Piping	Box pleat	Zipper
Headboard		x	x	
Frame			x	
It is possible to order main seam or decorative seam either tone in tone like the colours of cover or in the contrasting colours white, nature, grey, rust and black. On request special colours possible.				
Head- and side parts are removable!				



Slip cover bed with *zipper*

Processing options				
	Plain seam	Piping	Box pleat	Zipper
Headboard		x	x	x
Frame				x
It is possible to order main seam or decorative seam either tone in tone like the colours of cover or in the contrasting colours white, nature, grey, rust and black. On request special colours possible.				
Head- and side parts are removable!				

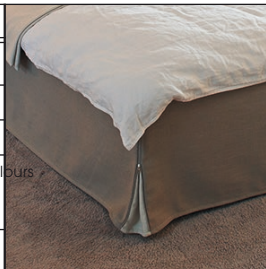

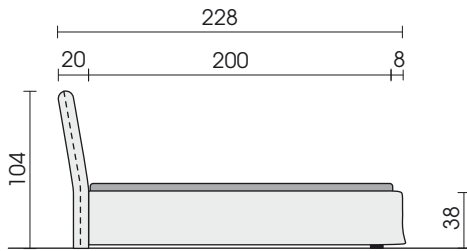

Side view

Slip cover bed with box pleat

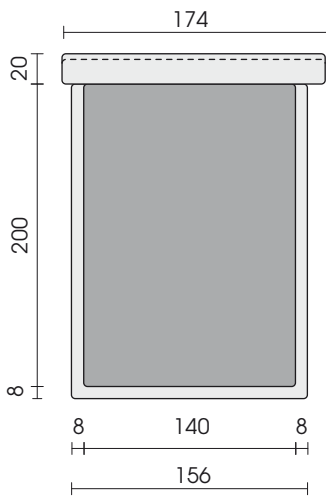

Bed 140 cm
B14

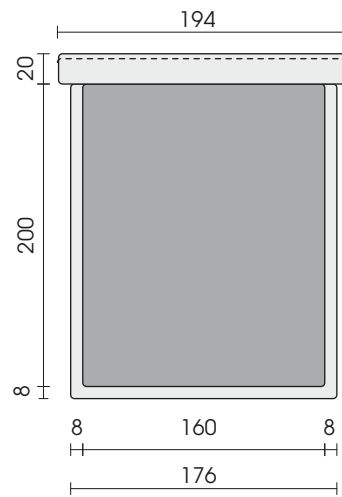

Bed 160 cm
B16

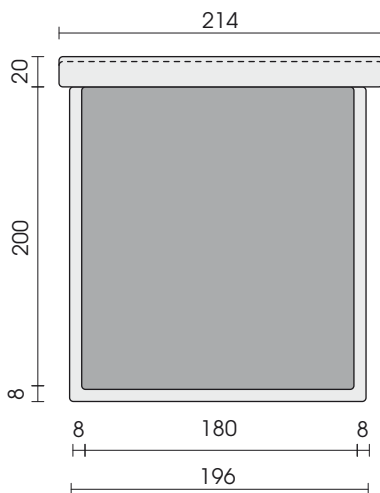

Bed 180 cm
B18

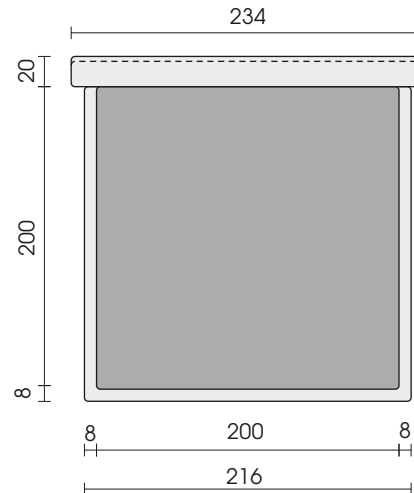

Bed 200 cm
B20

Each piece of furniture is handmade and unique. Deviations to the listed measurements may be caused by:
 1. different upholstery materials (fabric, leather), 2. processing of ticking mats, 3. the pressure to combine individual parts, etc.
 The seat comfort of a sofa type with larger seat depth usually differs from one with lower depth.

Slip cover bed with zipper

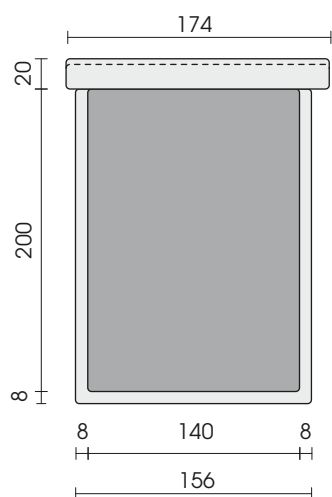

Bed 140 cm
Z14

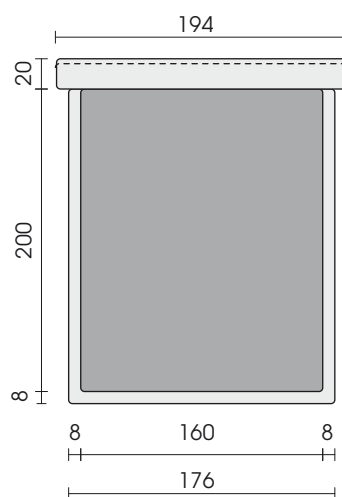

Bed 160 cm
Z16

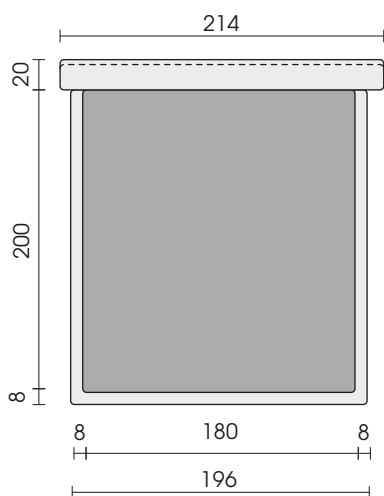

Bed 180 cm
Z18

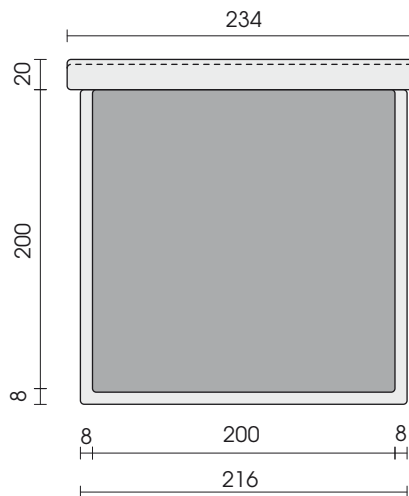

Bed 200 cm
Z20

Each piece of furniture is handmade and unique. Deviations to the listed measurements may be caused by:
1. different upholstery materials (fabric, leather), 2. processing of ticking mats, 3. the pressure to combine individual parts, etc.
The seat comfort of a sofa type with larger seat depth usually differs from one with lower depth.

Cushions with decorative seams are either tone in tone or contrasting colour possible.

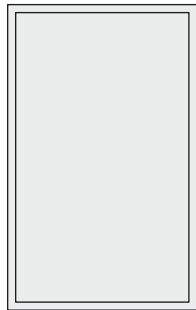

Decoration blanket
126 x 202
D30



Cushion
(tapered cushion)
(plain seam)
60 x 40
967



Cushion
to apply
(tapered cushion)
(fabric: piping)
60 x 40
936

Additional replacement covers are available:

Replacement cover for slip cover bed with box pleat

- Complete slip cover for bed 140 cm = H14
- Complete slip cover for bed 160 cm = H16
- Complete slip cover for bed 180 cm = H18
- Complete slip cover for bedt 200 cm = H20

Replacement cover for slip cover bed with zipper

- Complete slip cover for bed 140 cm = HZ4
- Complete slip cover for bed 160 cm = HZ6
- Complete slip cover for bed 180 cm = HZ8
- Complete slip cover for bed 200 cm = HZ0