

PRODUCT INFORMATION MODEL 2203 TIBOU

© 2022 KURT BEIER & KATI QUINGER



Low back, smaller seat depth,
manually adjustable head flap



High back, larger seat depth,
manually adjustable head flap



Individual, flexible adjustment



Motorised adjustable back



Manually adjustable armrest











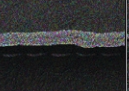

Practical stool

TIBOU: YOUR RETREAT AT HOME. AN ISLAND OF PEACE AND STRENGTH. A RETREAT FROM EVERYDAY LIFE! ELEMENTS WITH MODERN HIGH-BACK COMFORT! THE CUBIC BASIC SHAPE COMBINED WITH A CASUAL LOOK AND EXCELLENT FUNCTIONALITY CHARACTERISE THE DESIGN. ADJUSTABLE BACKRESTS AND HEADRESTS ALLOW INDIVIDUAL SITTING AND LYING POSITIONS. THE SEAT DEPTH IS REGULATED WITH THE HELP OF THE FOLDING MECHANISM. THE CORNER SECTION, FUNCTIONALLY SPECIAL, TURNS THE SOFA INTO A COSY CAVE. UNIQUE PIECE PRODUCTION.

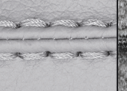

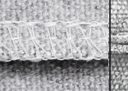
Plastic glides: 5 cm / Floor distance: 5 cm

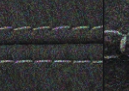
Processing options of main seam / decorative seam

	Plain seam	Lap seam	Raw edged	Moccasin seam extra charge	Twin seam extra charge	KR* (zipper piping) extra charge	Overcast seam extra charge	Piping	Two needle seam	Square seam extra charge
										
Fabric	x							x		
Leather	x									
Fur										
Fake fur	x									

It is possible to order main seam or decorative seam either tone like the colours of cover or in the contrasting colours white, nature, grey, rust and black. On request special colours possible.

*Zipper piping: optionally in the colours black, red, nature or light grey.



07.07.2023

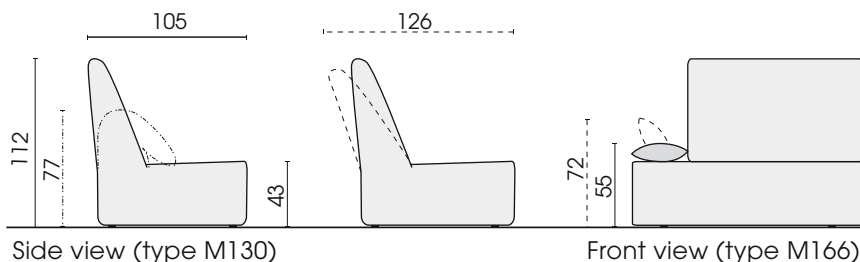

Armrest, type M166



▷ = Connector side

Single elements with manual headrest, motorised back

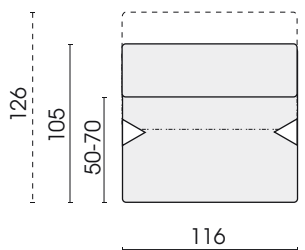

Element, back motorised **M130**

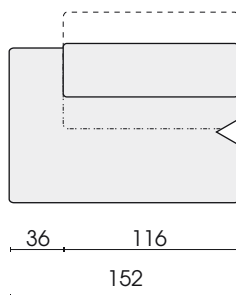

Element with add-on stool, left back motorised **M164**

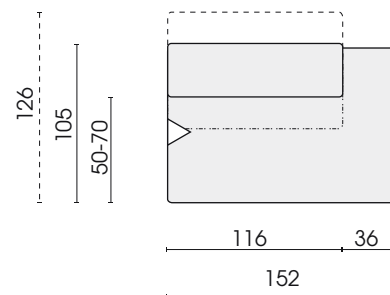

Element with add-on stool, right back motorised **M163**

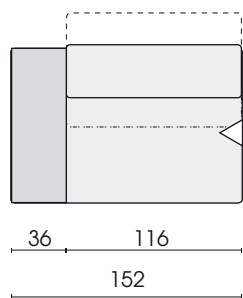

Element, armrest left, back motorised **M166**

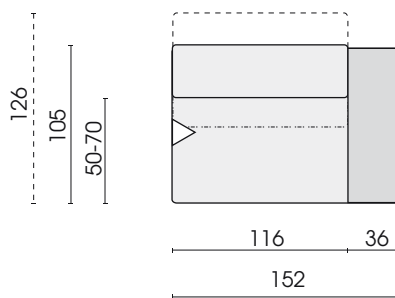

Element, armrest right, back motorised **M165**

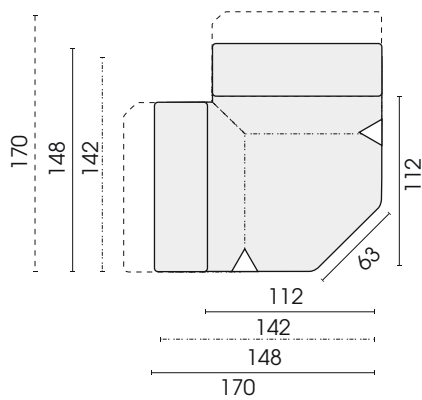

Corner element 2 backs motorised **M700**

Each piece of furniture is handmade and unique. Deviations to the listed measurements may be caused by:
 1. different upholstery materials (fabric, leather), 2. processing of ticking mats, 3. the pressure to combine individual parts, etc.
 The seat comfort of a sofa type with larger seat depth usually differs from one with lower depth.

Recamiere with manual headrest, motorised back

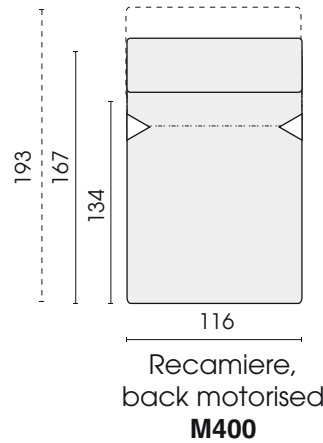

Stool/armrest

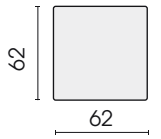

Stool
H = 42 cm
540

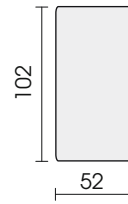

Armrest
H = 45 cm
634

Matching with stool type **540**
Table to apply on stool **0319 Tao Typ 859**

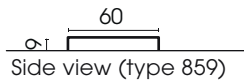

Table to apply on stool,
metal
Stool 540
matt black fine structure
powder-coated
removable
859

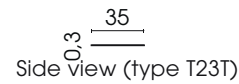

Table top, metal, loosely laid,
matching armrest 634, black matt
fine structure powder-coated
Table top
T23T

Cushions

Cushions with decorative seams are either tone in tone or contrasting colour possible.



Cushion
(tapered cushion)
(plain seam)
78 x 34
566

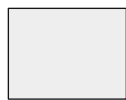

Cushion
(tapered cushion)
(plain seam)
78 x 60
949



Cushion
(tapered cushion)
(plain seam)
60 x 40
967



Cushion
(with dart)
(Fabric: plain seam)
(Leather: lap seam)
50 x 50
972



Cushion
(with dart)
(Fabric: plain seam)
(Leder: lap seam)
58 x 58
973

Each piece of furniture is handmade and unique. Deviations to the listed measurements may be caused by:
1. different upholstery materials (fabric, leather), 2. processing of ticking mats, 3. the pressure to combine individual parts, etc.
The seat comfort of a sofa type with larger seat depth usually differs from one with lower depth.

Combinations

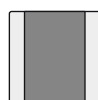
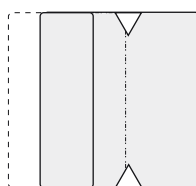
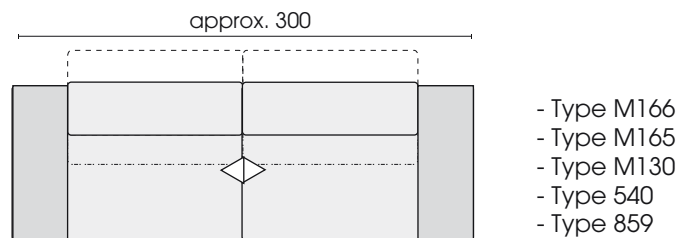
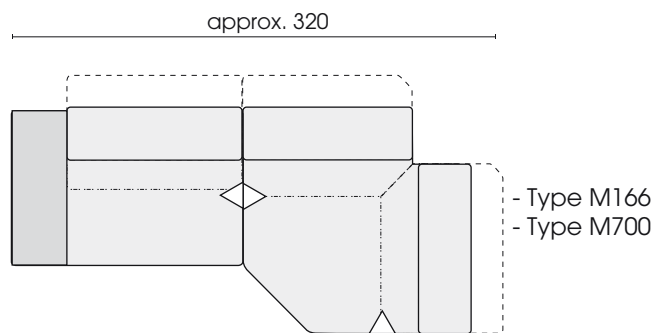
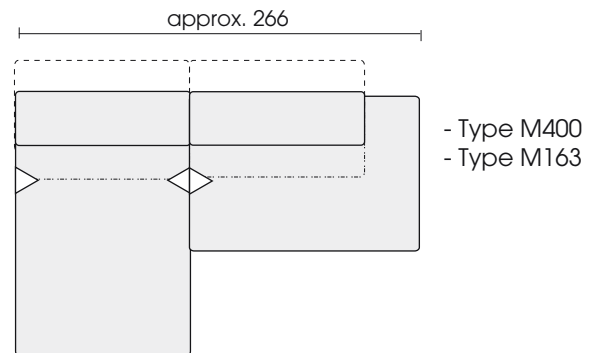
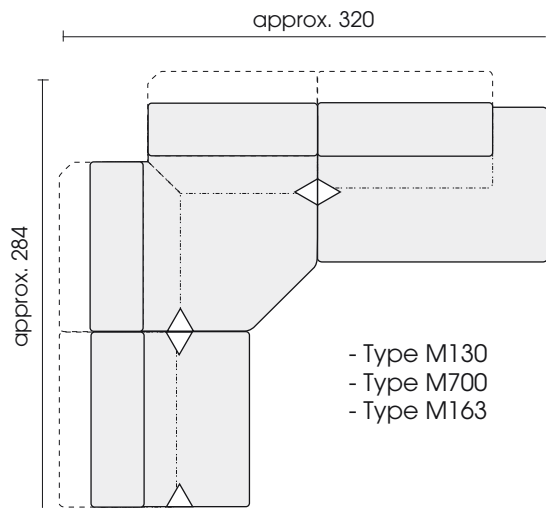

Each piece of furniture is handmade and unique. Deviations to the listed measurements may be caused by:
 1. different upholstery materials (fabric, leather), 2. processing of ticking mats, 3. the pressure to combine individual parts, etc.
 The seat comfort of a sofa type with larger seat depth usually differs from one with lower depth.