

visiostor

Catalog

 **Vistosi**

Contenuti / Contents

Vistosi

Indice / <i>Index</i>	4
Indice fotografico / <i>Photographic index</i>	6
Storia / <i>History</i>	8
I nostri numeri / <i>Our numbers</i>	18
Azienda / <i>Company</i>	19
Designer / <i>Designers</i>	20
Progetti / <i>Projects</i>	22

Prodotti / Products

Sospensioni / <i>Suspensions</i>	29
Plafoniere / <i>Ceiling</i>	225
Parete / <i>Wall</i>	287
Tavolo / <i>Table</i>	335
Terra / <i>Floor</i>	371

Informazioni / Information

Come leggere il catalogo / <i>How to read the catalog</i>	396
Legenda / <i>Keys</i>	397





Materiali / Materials

Colori del vetro / <i>Glass colours</i>	398
Finiture del vetro / <i>Glass finishes</i>	398
Finiture delle parti metalliche / <i>Metal parts finishes</i>	399
Altre finiture / <i>Other finishes</i>	399

Decentramenti / Swag systems	400
-------------------------------------	------------

Nuove caratteristiche LED 2021 / New LED features 2021	401
---	------------

Indice / Index

					
	SP	PL / FA	AP / PP	LT	PT
24PEARLS	120				
ALEGA				348	
ARIA	122				
ARMONIA NEW	110		300		
ASSIBA	108			359	
AURORA		258 ^{NEW}			
BACO	150				
BALANCE	144 ^{NEW}	232 ^{NEW}	306 ^{NEW}		
BISSONA				357	
BOLLE	118	244		364	
BOT	132 ^{NEW}	246 ^{NEW}			
CANDELA	188				
CLOTH	158		317		
CORNER			310		
CRISTALLINA	124				
DAFNE			312		
DAMASCO	168	268	318	365	388
DIADEMA	196	274	324	367	391
DIAMANTE	114	270			
DRESS	154				
ECOS	204	276	328		390
ESSENCE	194				
FEREA				356	
FUTURA NEW	64	252	305	353	383
GIOGALI	210	278	332		392
IMPLODE	130 ^{NEW}	248 ^{NEW}			
INCANTO NEW	92	228			
INFINITA	146 ^{NEW}	234 ^{NEW}			
JUBE	76 ^{NEW}		298 ^{NEW}	342 ^{NEW}	376 ^{NEW}
KIRA	176				
LACRIMA	182				
LEPANTO	186				382
LIO	178	256 ^{NEW}	322 ^{NEW}	358	
LUCCIOLA	140 ^{NEW}	266 ^{NEW}	308 ^{NEW}	354	384
MEDEA NEW	100				
MIA		260			
MINIGIOGALI	218	282	330	368	393
MIRAGE	160				

NEW: nuova collezione / new collection

NEW: collezione ampliata o modificata / extended or modified collection

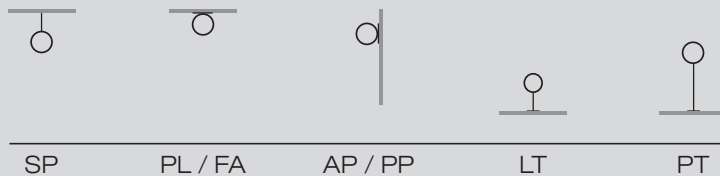

		SP	PL / FA	AP / PP	LT	PT
MORIS			238 ^{NEW}			
MUNEGA					360	
NARANZA		152				
NAXOS		148			362	385
NEOCHIC		136 ^{NEW}	236 ^{NEW}	294 ^{NEW}		
NESSA					349	
NINFEA		156				
NODO		162				
NOVECENTO		94	240		366	386
ORO	NEW	128				
OTO		44				
OVALINA				314		
PEGGY		56		290		378 ^{NEW}
PHOENIX	NEW	60				
PLOT	NEW	72				
PLOT FRAME	NEW	68		292		374
POC		126	269			
POD			230 ^{NEW}			
PUPPET		32		316	361	
PUPPET RING	NEW	40		296		
RIFLESSO	NEW	52			338	
RINA		98	242		346	
SABA			264 ^{NEW}			
SATA					350	380
SCINTILLA	NEW	88				
SEMAI		134	250			
SISSI		180				
SOGNO			262 ^{NEW}			
SPIRIT		86 ^{NEW}	254 ^{NEW}		369	
STARDUST		164		320		
STARNET	NEW	172				
STONE		104				
SURFACE		142				
TREAD	NEW	82		302	352	
TREPAI						381
TUBES		184	272			
VEGA				304	351	387
WHITWHITE		190				

Indice fotografico / *Photographic index*

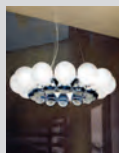

24Pearls
120

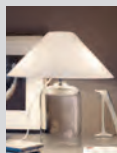

Alega
348



Aria
122

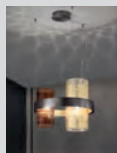

Armonia
110, 300



Assiba
108, 359



Aurora
258

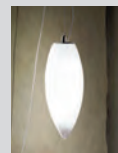

Baco
150



Balance
144, 232,
306



Bissona
357

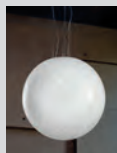

Bolle
118, 244,
364



Bot
132, 246

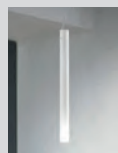

Candela
188



Cloth
158, 317



Corner
310



Cristallina
124



Dafne
312



Damasco
168, 268, 318,
365, 388

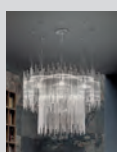

Diadema
196, 274, 324,
367, 391



Diamante
114, 270

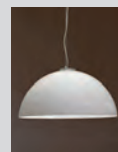

Dress
154

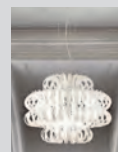

Ecos
204, 276,
328, 390

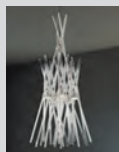

Essence
194



Ferea
356



Futura
64, 252, 305,
353, 383

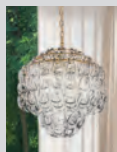

Giogali
210, 278,
332, 392

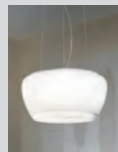

Implode
130, 248



Incanto
92, 228

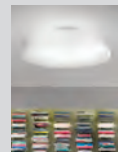

Infinita
146, 234

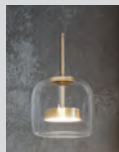

Jube
76, 298,
342, 376



Kira
176

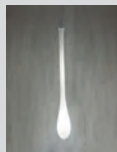

Lacrima
182

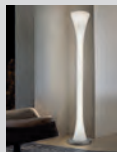

Lepanto
186, 382

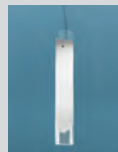

Lio
178, 256,
322, 358

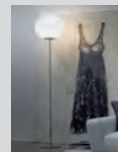

Lucciola
140, 266, 308,
354, 384



Medea
100

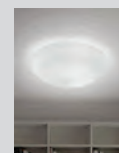

Mia
260

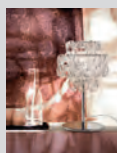

Minigiogali
218, 282, 330,
368, 393



Mirage
160



Moris
238

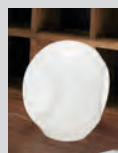

Munega
360

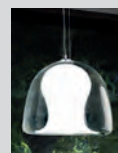

Naranja
152

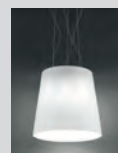

Naxos
148, 362,
385



Neochic
136, 236,
294



Nessa
349



Ninfea
156

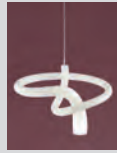

Nodo
162

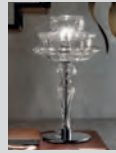

Novecento
94, 240,
366, 386



Oro
128

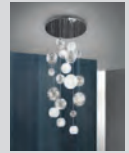

Oto
44



Ovalina
314

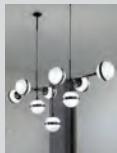

Peggy
56, 290,
378

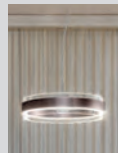

Phoenix
60

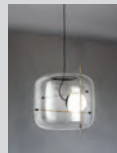

Plot
72



Plot Frame
68, 292,
374



Poc
126, 269

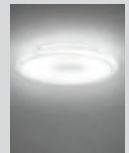

Pod
230

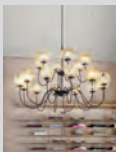

Puppet
32, 316,
361

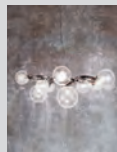

Puppet Ring
40, 296



Riflesso
52, 338



Rina
98, 242,
346



Saba
264

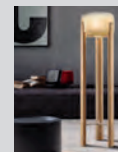

Sata
350, 380

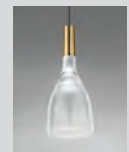

Scintilla
88



Semai
134, 250



Sissi
180



Sogno
262

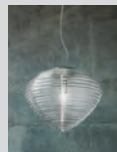

Spirit
86, 254,
369



Stardust
164, 320

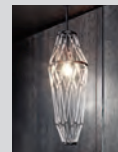

Starnet
172

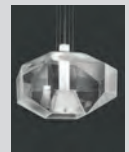

Stone
104

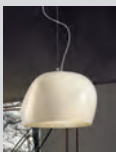

Surface
142



Tread
82, 302,
352

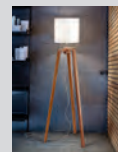

Trepai
381



Tubes
184, 272

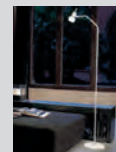

Vega
304, 351,
387

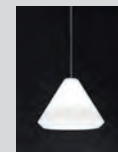

Whitwhite
190

Cinque secoli di storia / Five centuries of history

1585-1900

Le origini / The origins

Nelle acque della laguna veneziana affonda le sue origini la storia di Vetreria Vistosi.

The origins of Vetreria Vistosi stretch far back into the waters of the Venetian lagoon.

1585

Vincenzo Gazzabin, compare per la prima volta nei registri dell'arte vetraria muranese.

Vincenzo Gazzabin appeared for the first time in the registers of the Murano glass art.

1640

La famiglia Gazzabin, diventa proprietaria della fornace Al Bastian.

The Gazzabin family became the owner of the Al Bastian furnace.

1690

Il nome "Vistosi" fa la sua comparsa poco dopo, come soprannome di un erede della vetreria Gazzabin.

The name "Vistosi" appeared shortly afterwards as the nickname of an heir to the Gazzabin glassworks.

1791

Gio-Batta Vistosi viene nominato Gastaldo dell'Arte, capo dell'Arte dei Maestri Vetrai e rappresentante dei padroni delle fornaci muranesi.

Gio-Batta Vistosi was appointed Gastaldo dell'Arte, head of the glassmakers' guild and representative of the owners of the Murano furnaces.



1900-1980

Il Novecento / The twentieth century

Alla fine della seconda guerra mondiale, l'azienda inizia a concentrarsi nella produzione di articoli per l'illuminazione con Gino e Luciano Vistosi. È una storia di passione e di insaziabile ricerca del nuovo, che porta Vistosi ad iniziare importanti collaborazioni.

At the end of World War II, the company began to focus on the production of lighting products with Gino and Luciano Vistosi. That was a story of passion and insatiable search for the new, which led Vistosi to start important collaborations.

1945

Guglielmo Vistosi, erede della famiglia Gazzabin, dopo la fine della seconda guerra mondiale, apre una nuova fornace a Murano.

After the end of World War II Guglielmo Vistosi, heir of the Gazzabin family, opened a new furnace in Murano.

1969-1980

I nomi dei più famosi disegnatori dell'epoca, come Gae Aulenti, Angelo Mangiarotti, Ettore Sottsass senior e jr., Adalberto Dal Lago, Vico Magistretti, Albert Leclerc, si legano alla produzione Vistosi.

The most famous designers of the time, such as Gae Aulenti, Angelo Mangiarotti, Ettore Sottsass senior and jr., Adalberto Dal Lago, Vico Magistretti, Albert Leclerc, joined the Vistosi production.



1980-2000

La famiglia Moretti / *The Moretti family*

Da azienda artigiana a industria artigianale.
From craft business to craft industry.

1989

Giancarlo Moretti, imprenditore muranese da tempo attivo nel settore con Vetrofond e Punto Luce, rileva l'azienda dando vita a Vetreria Vistosi.

Giancarlo Moretti, an entrepreneur from Murano that had long been active in the sector with Vetrofond and Punto Luce, took over the company and created Vetreria Vistosi.

1993

Matteo Moretti, figlio di Giancarlo, attua una profonda riorganizzazione produttiva e commerciale per rilanciare il marchio.

Matteo Moretti, Giancarlo's son, carried out a deep productive and commercial reorganization to relaunch the brand.

1995

Viene creata una nuova miscela di vetro soffiato in cui è ridotto al minimo il contenuto di sodio. Il vetro acquista quasi le virtù dell'acciaio: resistenza e lucentezza.

A new blend of blown glass with a minimal amount of sodium was used. The glass has almost acquired the features of steel: it has become more resistant and brilliant.

Alcune nuove e importanti collaborazioni: Chiaramonte e Marin, Michele De Lucchi, Mauro Olivieri.

Some new and important collaborations: Chiaramonte e Marin, Michele De Lucchi, Mauro Olivieri.



2000-2005

Il Nuovo Millennio / *The New Millennium*

Ricerca e produzione si affinano per portare i prodotti Vistosi nei mercati esteri.

Research and production are improved to bring Vistosi products to foreign markets.

2002

Il taglio ad acqua (Water Jet) in uso nella lavorazione dei vetri piani, viene utilizzata negli articoli soffiati a bocca. Nasce Ferea.

Water jet cutting, used in the processing of flat glass, was used in mouth-blown items. Ferea was released.

2003

La lavorazione a membrana viene applicata all'illuminazione. Nasce Poc. L'argentatura delle superfici a specchio è impiegata nelle forme tridimensionali. Nasce Cheope.

The typical Murano membrane processing was applied to lighting. Poc was released. The silvering of the mirror surfaces was used in the three-dimensional forms. Cheope was released.

2004

La filatura a caldo applicata ad un intero prodotto. Nasce Damasco.

Hot spinning was applied to an entire product. Damasco was released.

2005

Nasce Giogali 3D, rivisitazione del gancio in forma tridimensionale e Diadema, le cui canne sono realizzate con una tecnica brevettata e non replicabile.

Giogali 3D, a revision of the hook in three-dimensional form, was released together with Diadema, whose rods are made with a patented, not replicable technique.

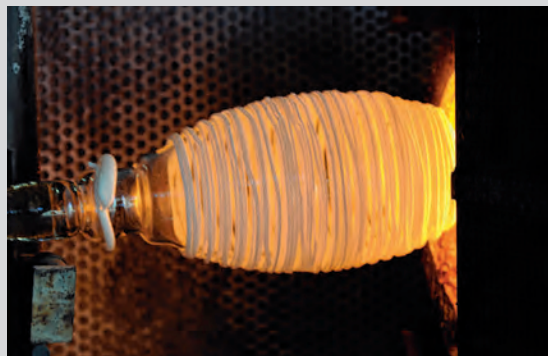

2006-2010

Nuovi riconoscimenti / New awards

2006

Diadema selezionata da ADI per il XXI Premio Compasso d'Oro.

Diadema was selected by ADI for the XXI Compasso d'Oro Award.

2007

Vistosi premiata da Eurispes, alla sua 2a edizione, come eccellenza del sistema Italia.

In its second edition Eurispes awarded a prize to Vistosi as excellence in the Italian system.

2009

Nascono Rina, in cui la tecnica della murrina è applicata a grandi dimensioni, Cheope09 con nuove texture create con la sabbiatura di precisione e Minigiogali la versione ridotta di Giogali.

Rina was released. The murrine technique was applied to large models. In the same year Cheope09 and the smaller size version of Giogali, named Minigiogali, were released.

2010

Per garantire ai suoi clienti l'unicità degli articoli, Vistosi da sempre brevetta modelli ornamentali, finiture e trattamenti. Nel perfezionamento di questo processo di tutela della qualità, dal 2010 è stata introdotta anche la marcatura del prodotto.

To make sure that its clients purchase a unique object, Vistosi has always patented its decorative models, finishes and treatments. During the enhancement of this process of quality protection, in 2010 the company introduced the branding of its products.



2011-2015

Ricerca e innovazione / Research and innovation

2011

Nascono Assiba, impreziosita dalle decorazioni raffinate della filigrana a reticello, arte del decoro nel vetro soffiato a freddo.

Con la cromatura ad effetto cangiante, Cloth regala gli effetti di due articoli in uno solo: lampada metallica da spenta, delicati riflessi color miele se accesa. Vega è la prima lampada a LED di Vistosi.

Assiba was released, embellished by the refined filigrana a reticello, the art of decoration in cold-blown glass. With its shimmering chrome plating, Cloth provides a double effect: a metallic lamp when it is off, and delicate honey reflections when it is on. Vega is the first LED lamp of Vistosi.

2013

Nasce nel laboratorio Vistosi un'innovativa miscela di cristallo dai grandi vantaggi estetici, tecnologici ed ecologici: il vetro soffiato senza piombo. Questo materiale ha le virtù dell'acciaio inox, in termini di durezza nel tempo e mantenimento delle caratteristiche originarie.

An innovative crystal mixture with great aesthetic, technological and ecological advantages was created in the Vistosi laboratory: the lead-free blown glass. This new blend possesses the qualities of stainless steel, in terms of durability and maintenance of its original characteristics.

2014

Tablò premiata con la menzione d'onore al grandesignEtico.

Tablò was awarded with a honourable mention at grandesignEtico.

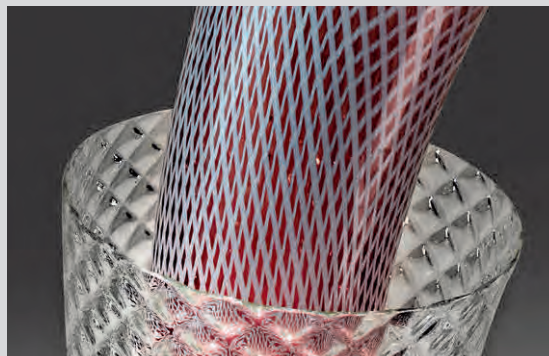

2016-2018

La storia recente / *Recent history*

2016

Futura vince Archiproduct Design Award.
Nodo selezionata da ADI per il XXV Premio
Compasso d'Oro.
Trepai premiata con la menzione d'onore al
grandesignEtico.

*Futura won the Archiproduct Design Award.
Nodo was selected by ADI for the XXV Compasso
d'Oro Award. Trepai was awarded with a honourable
mention at grandesignEtico.*

2017

50° Anniversario di Giogali.
Jube vince Archiproduct Design Award.
Sata vince il Good Design Award e il Red Dot
Design Award.
Stone vince il Good Design Award

*50th Anniversary of Giogali.
Jube won the Archiproduct Design Award.
Sata won the Good Design Award and the Red Dot
Design Award.
Stone won the Good Design Award.*

2018

Vistosi selezionata e premiata tra le 100 Eccellenze
Italiane per il Made in Italy.

*Vistosi was selected and awarded among the 100
Eccellenze italiane for Made in Italy.*

2019-2020

I giorni nostri / *Nowadays*

2019

Sata vince il German Design Award e IF
Design Award.
Riflesso vince Archiproduct Design Award.
Il marchio Vistosi viene registrato in Cina.
Trentesimo anniversario dell'acquisizione di Vistosi
della famiglia Moretti.

*Sata won the German Design Award and the
IF Design Award.*

*Riflesso won the Archiproduct Design Award.
The Vistosi trademark was registered in China.
Thirty years from the acquisition of Vistosi by
the Moretti family.*

2020

Nuove certificazioni UL, ETL e CB Test di quasi
tutti i prodotti a catalogo.

*New UL, ETL and CB Test certifications of nearly
all the products in the catalog.*

Nuova collezione Plot Frame
New Plot Frame collection.

Jube vince Archiproduct Design Award.
Jube won the Archiproduct Design Award.















I nostri numeri / *Our numbers*

80

Collections

300

Patented models

30

Metal parts finishes

12

Product Awards

80

Employees

8

Tons of glass
produced per day

80

Countries

5

Centuries of history

70

Years in business

30

Glass finishes

16

Registered trademarks
in Italy and abroad

15.000

MQ

Azienda / Company



Le radici di Vistosi affondano nel terreno produttivo della creatività e dell'artigianato veneziano, intrecciandosi con i fasti di una tradizione prestigiosa e senza tempo, quella del vetro. La sua è una storia lunga cinque secoli. Nel 1989 la famiglia muranese Moretti rileva il prestigioso marchio, dando vita a Vetreria Vistosi. Dal 1993 Matteo Moretti sale alla guida dell'azienda, portando avanti il fortunato binomio design-illuminazione e dando vita negli anni a collezioni che sono parte della storia del design. Giogali di Angelo Mangiarotti, Peggy, Futura e Stone di Hangar Design Group, Diadema di Romani Saccani Architetti Associati, Nodo di Pio e Tito Toso, Jube e Sata di Favaretto & Partners sono ormai icone: molte di loro molte delle quali hanno ricevuto premi anche internazionali, che rendono Vistosi riconoscibile in tutto il mondo.

Vistosi has its roots in the productive soil of Venetian creativity and craftsmanship, and these roots are intertwined with the splendour of a prestigious and timeless tradition, that of glass. Its history is five centuries long.

In 1989 the Moretti family from Murano took over the prestigious brand, creating Vetreria Vistosi. Since 1993 Matteo Moretti has taken the leadership of the firm linking the production to the names of the most famous designers of the time. This successful combination of design and lighting has given rise over the years to collections that are part of the history of design. Giogali by Angelo Mangiarotti, Peggy, Futura and Stone by Hangar Design Group, Diadema by Romani Saccani Architetti Associati, Nodo by Pio e Tito Toso, Jube and Sata by Favaretto & Partners are rewarded icons, recognized all over the world.

Premi / Awards



100 ECCellenze
ITALIANE

2007



- 2018 -

MENZIONE
D'ONORE

2018

DESIGNERS

Marco Acerbis • Spirit

Atelier Oi • Essence

Emmanuel Babled • Ferea, Pod

Giovanni Barbato • Aria, Mirage, Scintilla, Surface

Chiaramonte & Marin • Neochic, Plot, Plot Frame, Riflesso, Tread

Michele De Lucchi • Vega

Oriano Favaretto • Medea, Ninfea

Favaretto&Partners • Jube, Sata, Trepai,

Matthias Hickl per Lissoni Associati • Tubes

Hangar Design Group • Futura, Peggy, Stone

Andrea Lazzari • Phoenix

Francesco Lucchese • Armonia, Stardust

Vico Magistretti • Alega

Angelo Mangiarotti • Giogali, Giogali 3D, Minigiogali

Mauro Olivieri • Assiba, Baco, Withwhite

Romani Sacconi Architetti Associati • 24pearls, Cloth, Cristallina, Diadema, Novecento, Puppet, Puppet Ring

Alberto Saggia e Valerio Sommella • Kira, Semai

Gregorio Spini • Bot, Implode

Pio e Tito Toso • Balance, Incanto, Jo, Nodo, Oto

Renato Toso, Noti Massari & Associati • Ecos, Infinita

Gianni Veneziano e Luciana Di Virgilio | Veneziano+Team • Starnet

Luciano Vistosi • Lepanto, Munega

PREMI DI PRODOTTO / PRODUCT AWARDS



DIADEMA 2006



TABLÒ 2014



NODO 2016



FUTURA 2016



TREPAI 2016



JUBE 2017



SATA 2017



STONE 2017



SATA 2017



SATA 2019



JUBE 2019



RIFLESSO 2019



JUBE 2020



MEDEA 2020



ARMONIA 2020

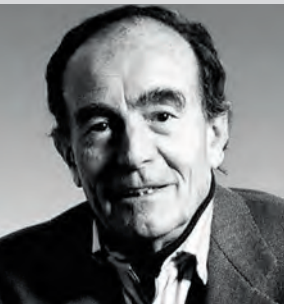
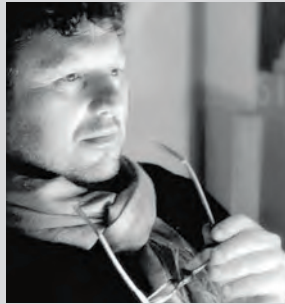
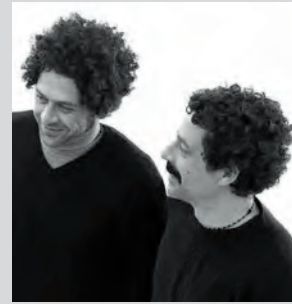

Progetti / Projects













Sospensioni / *Suspensions*

Plafoniere / <i>Ceiling</i>	225
Parete / <i>Wall</i>	287
Tavolo / <i>Table</i>	335
Terra / <i>Floor</i>	371

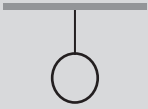

Sospensioni / *Suspensions*



24Pearls
120



Aria
122

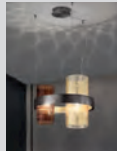

Armonia
110



Assiba
108

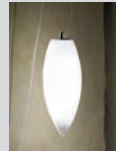

Baco
150



Balance
144



Bolle
118



Bot
132

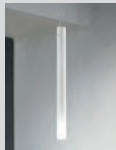

Candela
188



Cloth
158



Cristallina
124



Damasco
168

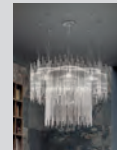

Diadema
196



Diamante
114



Dress
154



Ecos
204

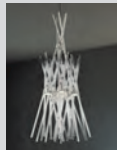

Essence
194

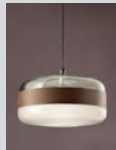

Futura
64

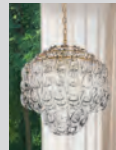

Giogali
210

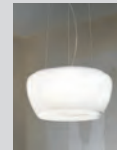

Implode
130

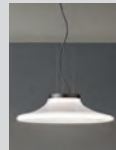

Incanto
92

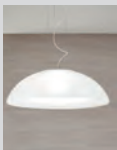

Infinita
146

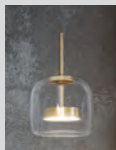

Jube
76



Kira
176

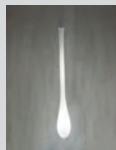

Lacrima
182

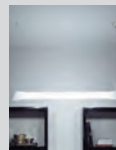

Lepanto
186



Lio
178

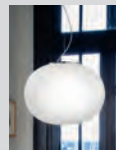

Lucciola
140



Medea
100

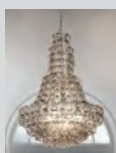

Minigiogali
218



Mirage
160

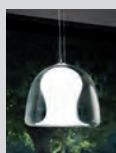

Naranja
152

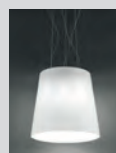

Naxos
148



Neochic
136



Ninfea
156

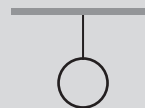

Sospensioni / *Suspensions*

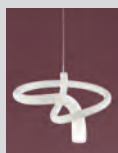

Nodo
162

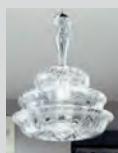

Novecento
94



Oro
128

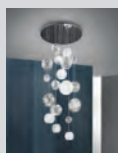

Oto
44



Peggy
56

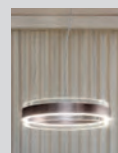

Phoenix
60

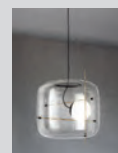

Plot
72

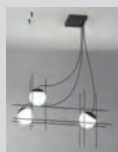

Plot Frame
68



Poc
126

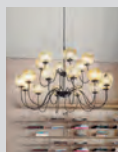

Puppet
32

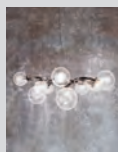

Puppet Ring
40



Riflesso
52



Rina
98



Scintilla
88



Semai
134



Sissi
180

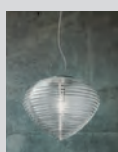

Spirit
86



Stardust
164

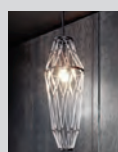

Starnet
172

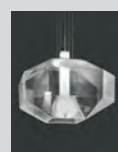

Stone
104

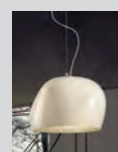

Surface
142

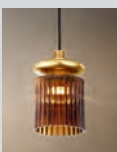

Tread
82



Tubes
184

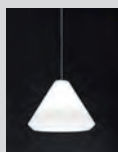

Whitwhite
190

PUPPET

design Romani Saccani Architetti Associati 2015



Puppet SP 24 P





PUPPET SP 6 P



max ø cm 80
max ø 32"

6x60W G9



USA & CANADA

6x60W G9

PUPPET SP 12 P

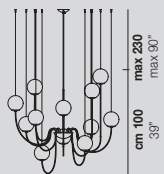

max ø cm 130
max ø 52"

12x60W G9



USA & CANADA

12x60W G9

PUPPET SP 18 P

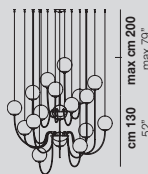

max ø cm 130
max ø 52"

18x60W G9



USA & CANADA

18x40W G9

PUPPET SP 24 P

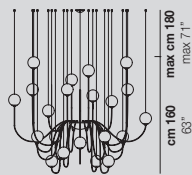

max ø cm 190
max ø 75"

24x60W G9



USA & CANADA

24x40W G9

PUPPET SP 36 P

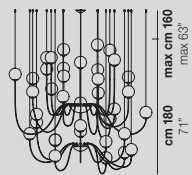

max ø cm 190
max ø 75"

36x40W G9



USA & CANADA

36x40W G9



Collezione di lampade in vetro soffiato e rigato irregolarmente. Le sfere di tre dimensioni differenti e le diverse altezze dei cavi sono studiate per creare eleganti composizioni. La versione chandelier permette di fissare a piacere a soffitto i diffusori con cavetti d'acciaio creando giochi sempre diversi.

Collection of lamps with a blown and irregular striped glass diffuser. The three sizes of the spheres and the different cable heights are designed to create elegant compositions. The chandelier version allows to fix the diffusers with steel cables to the ceiling, creating different games.

Finitura vetro / Glass finish

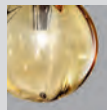

AM/TR



BC/SF

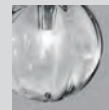

CR/TR

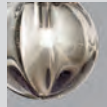

FU/TR



MC/1

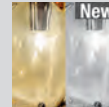

MC/2

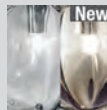

MC/3

MC/1 vetro / glass AM/TR + CR/TR + FU/TR

MC/2 vetro / glass AM/TR + CR/TR

MC/3 vetro / glass CR/TR + FU/TR

Finitura struttura / Frame finish

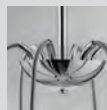

CR



NE

CR struttura cromo, cavo grigio / chrome frame, grey cable

NE struttura nera, cavo nero / black frame, black cable

Collezione / Collection



316



361



Puppet SP R12





Puppet SP L9

PUPPET SP P

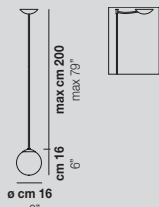

1x60W G9
 CE CB ENEC
 USA & CANADA
 1x60W G9

PUPPET SP M

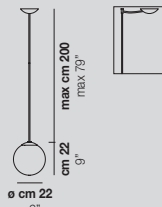

1x60W G9
 CE CB ENEC
 USA & CANADA
 1x60W G9

PUPPET SP G

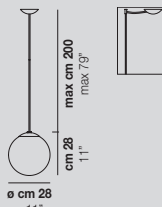

1x60W G9
 CE CB ENEC
 USA & CANADA
 1x60W G9

Collezione di lampade in vetro soffiato e rigato irregolarmente. Le sfere di tre dimensioni differenti e le diverse altezze dei cavi sono studiate per creare eleganti composizioni. La versione chandelier permette di fissare a piacere a soffitto i diffusori con cavetti d'acciaio creando giochi sempre diversi.

Collection of lamps with a blown and irregular striped glass diffuser. The three sizes of the spheres and the different cable heights are designed to create elegant compositions. The chandelier version allows to fix the diffusers with steel cables to the ceiling, creating different games.

PUPPET SP L6

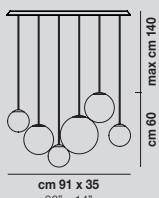

6x60W G9
 CE
 USA & CANADA
 6x60W G9

PUPPET SP L9

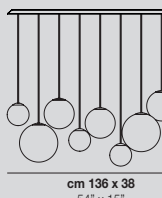

9x60W G9
 CE
 USA & CANADA
 9x60W G9

PUPPET SP R3

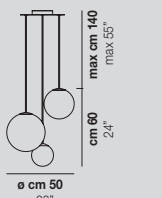

3x60W G9
 CE CB ENEC
 USA & CANADA
 3x60W G9

PUPPET SP R6

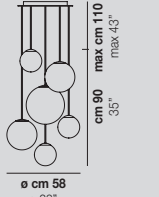

6x60W G9
 CE CB ENEC
 USA & CANADA
 6x60W G9

PUPPET SP R12

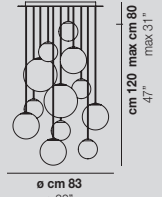

12x60W G9
 CE CB ENEC
 USA & CANADA
 12x40W G9

PUPPET SP R24

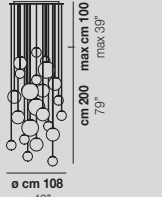

24x60W G9
 CE CB ENEC
 USA & CANADA
 24x40W G9

Finitura vetro / Glass finish

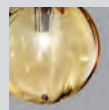

AM/TR



BC/SF

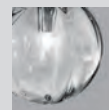

CR/TR

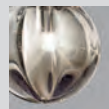

FU/TR



MC/1



MC/2

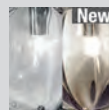

MC/3

MC/1 vetro / glass AM/TR + CR/TR + FU/TR

MC/2 vetro / glass AM/TR + CR/TR

MC/3 vetro / glass CR/TR + FU/TR

Finitura struttura / Frame finish

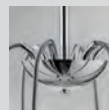

CR



NE

CR struttura cromo, cavo grigio / chrome frame, grey cable

NE struttura nera, cavo nero / black frame, black cable

Collezione / Collection



316



361

PUPPET RING

design Romani Sacconi Architetti Associati 2019



Puppet Ring SP 5



Puppet Ring_SP 9



Puppet Ring SP 7

PUPPET RING SP 5

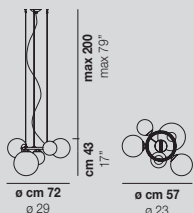

5×60W G9



USA & CANADA

5×60W G9

PUPPET RING SP 7

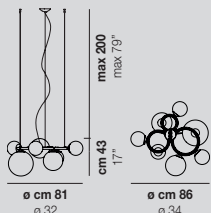

7×60W G9



USA & CANADA

7×60W G9

PUPPET RING SP 9

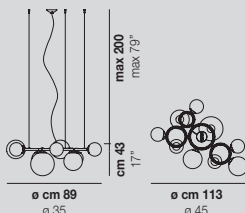

9×60W G9



USA & CANADA

9×60W G9

L'elemento distintivo di questo modello della collezione Puppet Ring sono gli anelli con diametro crescente, che possono essere accostati con sequenze differenti per costituire l'armatura su cui andare ad appoggiare le preziose sfere in vetro di tre dimensioni differenti che si fondono con la struttura grazie ad una preformatura interna al vetro soffiato. Esteticamente leggero ed elegante, Puppet Ring coniuga in modo etereo vetro cristallo, fumé, ambra e bianco sfumato con finiture oro e nickel nero satinato.

The distinctive feature of this model from the Puppet Ring collection are the rings with increasing diameter. They can be combined in different sequences to form the framework on which the precious glass spheres in three different sizes are placed, blending with the structure thanks to a preformation inside the blown glass. Aesthetically light and elegant, Puppet Ring ethereally combines crystal, smoky, amber and shaded white glass with gold and black matt nickel finishes.



Finitura vetro / Glass finish

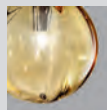

AM/TR



BC/SF

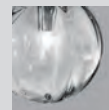

CR/TR

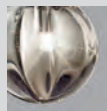

FU/TR

Finitura struttura / Frame finish

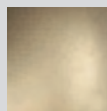

BKS

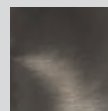

NNS

Collezione / Collection

o |
296

OTO

design Pio e Tito Toso 2015



Oto SP LIN









OTO SP R55

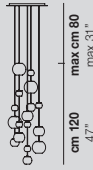

ø cm 55
ø 22"

9×60W G9



USA & CANADA

9×60W G9

OTO SP R60

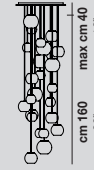

ø cm 60
ø 24"

10×60W G9



USA & CANADA

10×60W G9

OTO SP RC

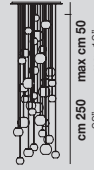

ø cm 82
ø 32"

12×60W G9



USA & CANADA

12×60W G9

OTO SP CHA

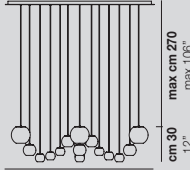

ø cm 140
ø 55"

9×60W G9



USA & CANADA

9×60W G9

OTO SP FC

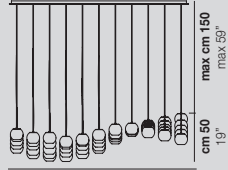

cm 169 x 76
66" x 30"

12×60W G9



USA & CANADA

12×60W G9

OTO SP SUR

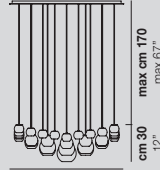

cm 108 x 108
42" x 42"

17×60W G9



USA & CANADA

17×60W G9

OTO SP CUB

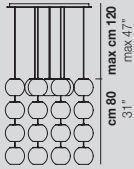

cm 80 x 80
31" x 31"

16×60W G9



USA & CANADA

16×60W G9

OTO SP SPH

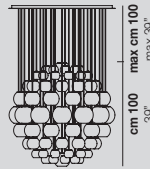

ø cm 100
ø 39"

13×60W G9



USA & CANADA

13×60W G9

OTO SP LIN

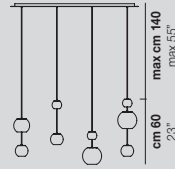

cm 120 x 18
ø 47" x 7"

4×60W G9



USA & CANADA

4×60W G9

Elementi sferici in vetro soffiato disponibili in tre misure e quattro colori vetro con lavorazione rigadin, con e senza sorgente luminosa. Il particolare design permette l'installazione verticale di più elementi in vetro ed infinite composizioni a scelta del cliente.

Spherical blown glass elements available in three sizes and four rigadin colours, with and without lighting source. The special design allows the vertical installation of several glass elements and infinite customized combinations.

Finitura vetro / Glass finish



AM/RI



BC/RI



CR/RI



FU/RI

Finitura struttura / Frame finish



AS



BC

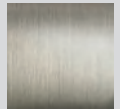

NI



OTO SP 12

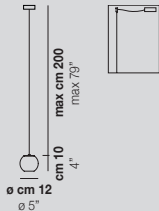

1x60W G9
CE **CB ENEC**
USA & CANADA
 1x60W G9

OTO SP 15

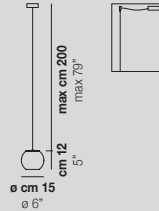

1x60W G9
CE **CB ENEC**
USA & CANADA
 1x60W G9

OTO SP 18

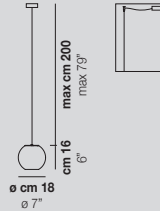

1x60W G9
CE **CB ENEC**
USA & CANADA
 1x60W G9

OTO SP PEA

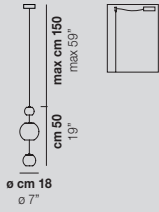

1x60W G9
CE **CB ENEC**
USA & CANADA
 1x60W G9

OTO SP PEB

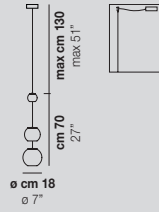

1x60W G9
CE **CB ENEC**
USA & CANADA
 1x60W G9

OTO SP PEC

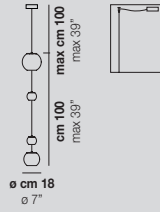

1x60W G9
CE **CB ENEC**
USA & CANADA
 1x60W G9

OTO SP PED

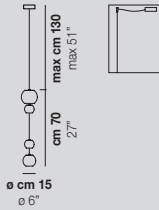

1x60W G9
CE **CB ENEC**
USA & CANADA
 1x60W G9

Elementi sferici in vetro soffiato disponibili in tre misure e quattro colori vetro con lavorazione rigadin, con e senza sorgente luminosa. Il particolare design permette l'installazione verticale di più elementi in vetro ed infinite composizioni a scelta del cliente.

Spherical blown glass elements available in three sizes and four rigadin colours, with and without lighting source. The special design allows the vertical installation of several glass elements and infinite customized combinations.

Finitura vetro / Glass finish



AM/RI BC/RI CR/RI



FU/RI

Finitura struttura / Frame finish



AS BC NI

RIFLESSO

design Chiaramonte & Marin 2019





Riflesso SP 3 / 2 / 1



RIFLESSO SP 1

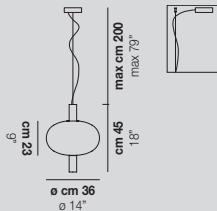

1x12,5W LED 10

CE ENEC PS

USA & CANADA cULus

1x12,5W LED 10

RIFLESSO SP 2

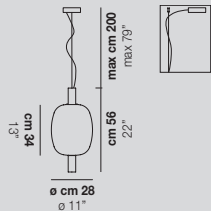

1x12,5W LED 10

CE ENEC PS

USA & CANADA cULus

1x12,5W LED 10

RIFLESSO SP 3

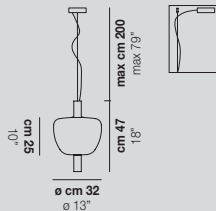

1x12,5W LED 10

CE ENEC PS

USA & CANADA cULus

1x12,5W LED 10

Nella collezione Riflesso la semplicità e la leggerezza del vetro diventano protagoniste in tre diverse forme sinuose. Le silhouette del diffusore vengono esaltate dalla sorgente luminosa a LED. Le sospensioni presentate assieme o singolarmente caratterizzano l'ambiente con eleganza.

In the Riflesso collection the simplicity and lightness of glass become the main features with three different sinuous shapes. The silhouettes of the diffuser are enhanced by the LED light source. The suspensions, presented together or individually, characterise the environment with elegance.

Finitura vetro / Glass finish

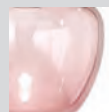

AA/TR



AM/TR



CR/TR

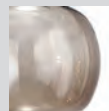

FU/TR

SP 1 solo AM/TR, CR/TR / SP 1 only AM/TR, CR/TR

SP 2 solo CR/TR, FU/TR / SP 2 only CR/TR, FU/TR

SP 3 solo AA/TR, CR/TR / SP 3 only AA/TR, CR/TR

Finitura struttura / Frame finish

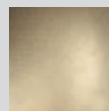

BKS

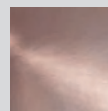

RAV

LED Europe/International CE ENEC PS

10 12,5W - 35V - 1500lm - 2700K/3000K - DIM2/DIM3

LED Usa & Canada cULus

10 12,5W - 35V - 1500lm - 2700K/3000K - DIM2/DIM3



Collezione / Collection



archiproducts
DESIGN AWARDS
WINNER 2019

RIFLESSO 2019



338

PEGGY
design Hangar Design Group 2017





Peggy SP 9



PEGGY SP



1x60W E14



USA & CANADA

1x40W E12

PEGGY SP 9

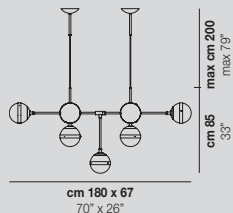

9x60W E14



USA & CANADA

9x40W E12

Il bianco e il nero. Da questa polarità cromatica e materica nasce Peggy. Il progetto illuminotecnico concilia la leggerezza del vetro soffiato bianco lucido, lavorato interamente a mano, con il carattere più vivace del metallo lucido nero o dell'ottone antico. Il connubio di grande effetto comunica razionalità e eleganza al tempo stesso.

White and black. Peggy was created starting from this chromatic and material polarity. This lighting design combines the lightness of glossy white blown glass, entirely handmade, with the liveliest character of the glossy metal black or antique brass. This effective combination conveys rationality and elegance at the same time.

Finitura vetro / Glass finish

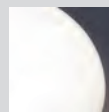

BC/LU

Finitura struttura / Frame finish

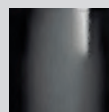

NEL



OT



Collezione / Collection

290

378

PHOENIX

design Andrea Lazzari 2019





Phoenix SP



Phoenix SP

PHOENIX SP

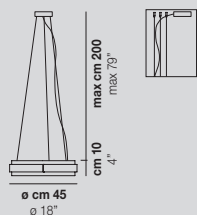

1x35W LED 08

CE ENEC

USA & CANADA

1x35W LED 08

Elegante gioco di geometrie ed incastri circolari dalla forte connotazione decorativa, che arreda ed illumina l'ambiente con una personalità decisa ma discreta. La fonte luminosa a LED è molto efficiente e completamente nascosta nella struttura. L'illuminazione diretta definisce la zona di luce sottostante, esaltando la naturale bellezza delle tonalità fumé e cristallo impreziosite da finiture nickel nero e rame satinato.

An elegant game of geometries and circular joints with a strong decorative connotation, which embellishes and illuminates the room with a strong but discreet personality. The LED light source is very efficient and completely hidden in the structure. The direct lighting defines the area of light underneath, enhancing the natural beauty of the smoked and crystal tones, which are embellished with matt black nickel and copper finishes.

Finitura vetro / Glass finish



CR/TR



FU/TR

Finitura struttura / Frame finish

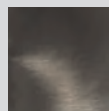

NNS

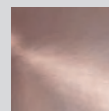

RAV



LED Europe/International CE ENEC

08 35W - 24V - 3800lm - 2700K/3000K - DIM2

LED Usa & Canada

08 35W - 24V - 3800lm - 2700K/3000K - DIM2

FUTURA

design Hangar Design Group 2015







FUTURA SP P

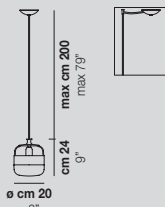

1x77W E27 / LED C
 CE ENEC CB ENEC PS
 USA & CANADA
 1x60W E26 / LED C

FUTURA SP M

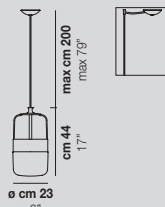

1x77W E27 / LED C
 CE ENEC CB ENEC PS
 USA & CANADA
 1x60W E26 / LED C

FUTURA SP G

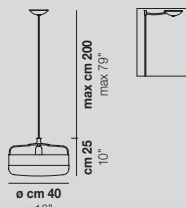

1x77W E27 / LED C
 CE ENEC CB ENEC PS
 USA & CANADA
 1x60W E26 / LED C

FUTURA SP 3

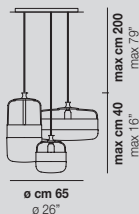

3x77W E27
 CE ENEC CB ENEC PS
 USA & CANADA
 3x60W E26



Collezione di lampade costituite da un pezzo unico di vetro soffiato la cui particolare lavorazione però permette un doppio effetto cromatico: trasparente nella parte superiore, effetto satinato nella parte inferiore. Sono disponibili le seguenti possibilità di abbinamento vetro con anello metallico: vetro bianco con anello nero opaco, vetro fumé con anello marrone, vetro ambra con anello ottone. Nuova finitura vetro cristallo trasparente con possibilità di abbinare anello rame o nero opaco.

A collection of lamps made from a single piece of blown glass, whose particular workmanship, though, allows a double chromatic effect: transparent at the top, satin effect at the bottom. The following combinations of glass with metal ring are now available: white glass combined with matt black ring, smoky glass with brown ring, amber glass with painted brass ring. A new transparent crystal glass finish with copper or matt black ring is also available.

Finitura vetro / Glass finish



Finitura struttura / Frame finish

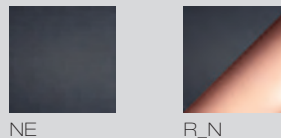

LED Europe/International CE ENEC
 C 12W - 35V - 1500lm/1600lm - 2700K/3000K - DIM2/DIM3

LED Usa & Canada
 C 12W - 35V - 1500lm/1600lm - 2700K/3000K - DIM2/DIM3

Collezione / Collection



PLOT FRAME

design Chiaramonte & Marin 2020



Plot Frame SP 4





PLOT FRAME SP 3

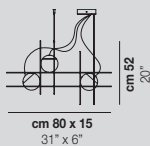

3x8,5W 3750 lm **LED 17**

CE EAC

USA & CANADA 

3x8,5W 3750 lm **LED 17**

PLOT FRAME SP 4

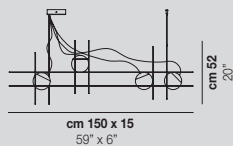

4x8,5W 5000 lm **LED 17**

CE EAC

USA & CANADA 

4x8,5W 5000 lm **LED 17**

L'ispirazione dalla quale nasce la linea Plot Frame è la semplicità della sfera e il tentativo di rappresentarne il movimento. Una trama metallica all'interno della quale sfere di vetro luminescenti sono quasi libere di muoversi consentendo al fruitore di interagire con l'oggetto. Montatura nera opaca. Sorgente luminosa LED.

The inspiration behind Plot Frame is to render the motion and simplicity of a sphere. A metal weave where luminescent glass spheres are almost free to move, allowing the user to interact with the object. Matt black frame. LED light source.

Finitura vetro / Glass finish

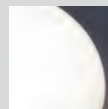

BC/LU

Finitura struttura / Frame finish

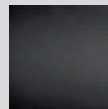

NEO

LED Europe/International 

17 8,5W - 24V - 1250 lm - 2700K/3000K - DIM2/DIM3

LED Usa & Canada 

17 8,5W - 24V - 1250 lm - 2700K/3000K - DIM2/DIM3



Collezione / Collection

292

374

PLOT

design Chiaramonte & Marin 2019







PLOT SP

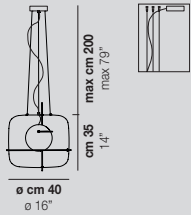

1x11,5W LED 09

CE ENEC

USA & CANADA 

1x8,5W LED 09

Perfetto dialogo tra differenti materiali e la fonte luminosa sospesa: questa è Plot. Ispirata agli intrecci delle impalcature orientali di bambù, Plot conferisce una sensazione di leggerezza e di sospensione, data dal gioco di equilibri in cui la sorgente luminosa a LED è sostenuta attraverso l'intreccio delle bacchette metalliche. Plot unisce materiali diversi tra loro come il metallo nero o ottone satinato ed il vetro in tonalità cristallo o fumé.

A perfect dialog between different materials and a suspended light source: that is Plot. Inspired by the weaving of oriental bamboo scaffolding, Plot gives a feeling of lightness and suspension, thanks to the play of balances where the light source is supported through the interweaving of the metal rods. Plot combines different materials such as black metal or brass satin finishes with crystal or smoky glass.

Finitura vetro / Glass finish



CR/NE

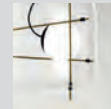

CR/OT



FU/NE

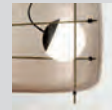

FU/OT

Finitura struttura / Frame finish

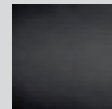

NEO

LED Europe/International 

09 11,5W - 25V - 1600lm - 2700K/3000K - DIM2/DIM3

LED Usa & Canada 

09 8,5W - 25V - 1250lm - 2700K/3000K - DIM2/DIM3



JUBE

design Favaretto&Partners 2017







Jube SP 1 G





JUBE SP S

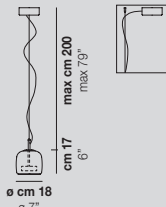

1x8,5W LED 14



USA & CANADA

1x8,5W LED 14

JUBE SP 1 P

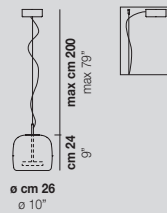

1x13W LED 02



USA & CANADA

1x13W LED 02

JUBE SP 1 G

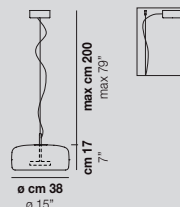

1x13W LED 02



USA & CANADA

1x13W LED 02

JUBE SP P

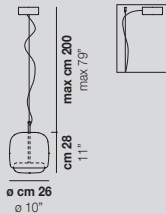

1x13W LED 02



USA & CANADA

1x13W LED 02

JUBE SP G

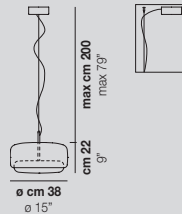

1x13W LED 02



USA & CANADA

1x13W LED 02

L'aspetto elegante e delicato del vetro soffiato trova in Jube una nuova dimensione. Due vetri accostati, perfettamente assemblati, da sembrare un pezzo unico. Una lampada sinuosa, con colori tono su tono che le regalano un prezioso mood vintage.

The elegant and delicate look of the blown glass finds a new dimension in Jube. Two glass units placed side by side, so perfectly assembled, that they look like a unique piece. A sinuous lamp, with tone-on-tone colours that give it a precious, vintage mood.

Finitura vetro / Glass finish



Finitura struttura / Frame finish

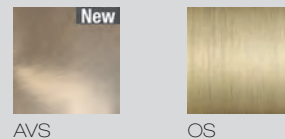

LED Europe/International

02 13W - 37V - 2000lm - 2700K/3000K - DIM2/DIM3

14 8,5W - 24V - 1200lm - 2700K/3000K - DIM2/DIM3

LED Usa & Canada

02 13W - 37V - 2000lm - 2700K/3000K - DIM2/DIM3

14 8,5W - 24V - 1200lm - 2700K/3000K - DIM2/DIM3

Collezione / Collection



TREAD

design Chiaramonte & Marin 2019







Tread SP

TREAD SP

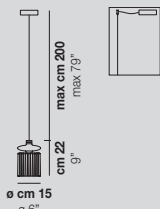

1x12W LED 13

CE ENEC

USA & CANADA 

1x12W LED 13



La "tecnicità" dell'elemento metallico unito al diffusore in vetro soffiato conferisce a Tread uno stile "industriale". Un oggetto che ricorda le apparecchiature elettriche vintage per la sua forma particolare, in cui il dissipatore alettato, unito al vetro soffiato, diviene elemento caratterizzante. Tread crea un'atmosfera all'avanguardia e di stile coniugando il vetro cristallo, fumé, terra bruciata e verde antico trasparente con finiture rame, oro e bronzo satinato.

The "technicity" of the metal element combined with the blown glass diffuser gives Tread an "industrial" style. An object reminiscent of vintage electrical equipment for its particular shape, in which the finned heat sink, combined with blown glass, becomes a distinctive element. Tread creates an avant-garde and stylish atmosphere by combining crystal, smoky, burned earth and transparent old green glass with copper, gold and bronze matt finishes.

Finitura vetro / Glass finish

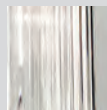

CR/TR

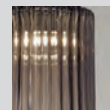

FU/TR

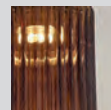

TB/TR



VA/TR

Finitura struttura / Frame finish

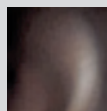

BHS

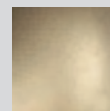

BKS

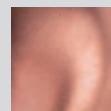

FAS

LED Europe/International 

13 12W - 35V - 1500lm/1600lm - 2700K/3000K - DIM2/DIM3

LED Usa & Canada



13 12W - 35V - 1500lm/1600lm - 2700K/3000K - DIM2/DIM3

Collezione / Collection

302

352

SPRIT

design Marco Acerbis 2013



Spirit SP 37

SPIRIT SP 37

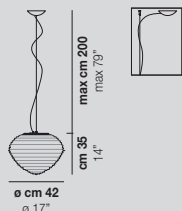

1x77W E27 / **LED F**
 CE
 USA & CANADA
 1x60W E26 / **LED F**

SPIRIT SP 45

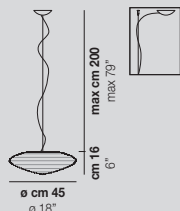

2x77W E27 / **LED G**
 CE
 USA & CANADA
 2x60W E26 / **LED G**

Spirit ha la forma del diamante soffiata nel vetro. Le particolari rigature, frutto di una lunga ricerca, catturano la luce e la riflettono, nascondendo la sorgente luminosa anche nella versione in cristallo trasparente.

Spirit has the shape of a diamond blown into glass. Its folds are the result of a long process of development that creates a unique light reflection, while keeping the source of light hidden even in the transparent crystal version.

Finitura vetro / Glass finish

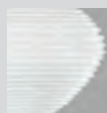

BC/LU



CR/TR

Finitura struttura / Frame finish

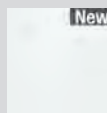

BO*

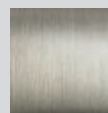

NI

LED version: BO*



LED Europe/International

F 12W - 24V - 1700 lm - 2700K/3000K - DIM2/DIM3

G 19W - 39V - 2850 lm - 2700K/3000K - DIM2/DIM3

LED Usa & Canada

F 12W - 24V - 1700 lm - 2700K/3000K - DIM2/DIM3

G 19W - 39V - 2850 lm - 2700K/3000K - DIM2/DIM3

LED F e G disponibili solo con finitura vetro BC/LU

LED F and G only available with BC/LU glass finish

Collezione / Collection



254



369

SCINTILLA

design Giovanni Barbato 2019



Scintilla SP





Scintilla SP

SCINTILLA SP

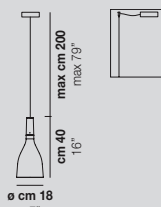

1x12W LED 11

CE EAC

USA & CANADA cULus

1x12W LED 11



Scintilla è una forma classica, senza tempo. La sorgente LED accende la silhouette contenuta e sinuosa, creando giochi di luce ed emozione grazie al fondo pieno del suo bicchiere in vetro. Nel suo nome è insita l'idea, la forma della luce che prende vita nelle trasparenze del cristallo. Questi toni leggeri si accompagnano armoniosamente con il rame, il bronzo e l'oro lucido della montatura.

Scintilla is a classic, timeless form. The LED source lights up its sober and sinuous silhouette, creating patterns of light and emotion thanks to the full bottom of its glass cup. In its name lies the idea and shape of the light that come to life in the transparencies of the crystal. These glass tones combine harmoniously with copper, bronze and gold glossy finishes.

Finitura vetro / Glass finish



CR/TR

Finitura struttura / Frame finish

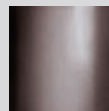

BH

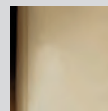

OG

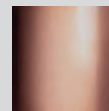

RA

LED Europe/International

CE EAC

11 12W - 35V - 1500lm/1600lm - 2700K/3000K - DIM2/DIM3

LED Usa & Canada

cULus

11 12W - 35V - 1500lm/1600lm - 2700K/3000K - DIM2/DIM3

INCANTO

design Pio & Tito Toso 2019



Incanto SP

INCANTO SP

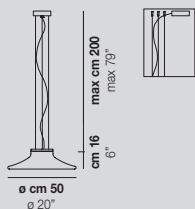

1x15W LED 03

CE EAC

USA & CANADA 

1x15W LED 03

La sorgente LED accende il vetro sfumato bianco. I toni neutri e le linee semplici ed eleganti permettono di contestualizzarla in ambienti dagli stili più diversi. Montatura nickel nero satinato o bianca.

The LED source lights up the white shaded glass. Neutral tones and simple, elegant lines allow it to be contextualised in environments with the most diverse styles. Black matt nickel or white metal finishes.

Finitura vetro / Glass finish



BC/SF

Finitura struttura / Frame finish



BO

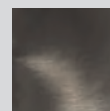

NNS

LED Europe/International

CE EAC

03 15W - 230V - 1300lm - 3000K - DIM2

LED Usa & Canada



03 15W - 110V - 1200lm - 3000K - DIM2



BC/SF_BO

Collezione / Collection



228

NOVECENTO

design Romani Saccani Architetti Associati 2013







Novocento SP P

NOVECENTO SP P

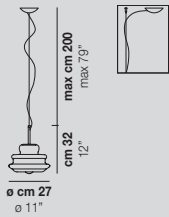

1x60W E14



USA & CANADA

1x40W E12

NOVECENTO SP M

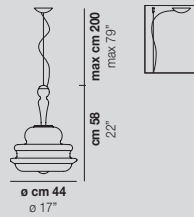

1x77W E27



USA & CANADA

1x60W E26

NOVECENTO SP G

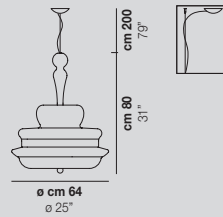

5x60W E14



USA & CANADA

5x40W E12

La forma di questa collezione nasce dalla volontà di reinterpretare il tradizionale lampadario muranese. Finitura del vetro cristallo o bianco rigadin è stata il tocco da maestro: le sue rigature radiali evocano l'andamento dei bracci dello storico candeliere mantenendo un sapore contemporaneo.

The shape of this collection stems from the desire to reinterpret the traditional Murano chandelier. The choice of the crystal or white rigadin glass finish was the master's touch: its radial stripes evoke the arms of the historic candlestick while maintaining a contemporary flavour.

Finitura vetro / Glass finish



BC/RI



CR/RI

Finitura struttura / Frame finish



CR



Collezione / Collection



240



366



386

RINA

design Barbara Maggiolo 2009



Rina SP 45

RINA SP 16

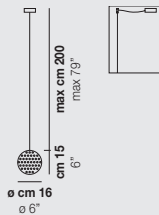

1×60W G9 / **LED B**
CE **CB ENEC**
USA & CANADA
 1×60W G9 / **LED B**

RINA SP 25

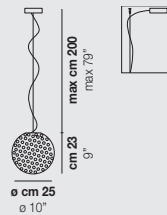

1×77W E27
CE **CB ENEC**
USA & CANADA
 1×60W E26

RINA SP 35

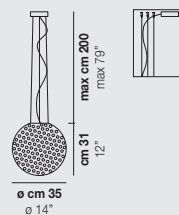

1×77W E27
CE **CB ENEC**
USA & CANADA
 1×60W E26

Si ispira al tarassaco, del quale ricorda il pappo, grazie alla leggera texture della superficie, realizzata con la tradizionale tecnica delle murrine. Rina è disponibile in diverse misure che si possono combinare in un'ampia gamma di installazioni.

Rina is inspired by the dandelion, of which it recalls the pappus, thanks to the light texture of the surface, made with the traditional technique of murrine. It is available in different sizes that can be combined in a wide range of installations.

RINA SP 45

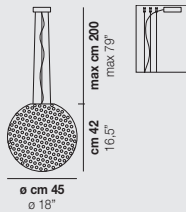

3×77W E27
CE **CB ENEC**
USA & CANADA
 3×60W E26

Finitura vetro / Glass finish



BC/MU

Finitura struttura / Frame finish

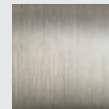

NI

LED Europe/International **CE ENEC**

B 9W - 34V - 1100lm/1200lm - 2700K/3000K - DIM2/DIM3

LED Usa & Canada

B 9W - 34V - 1100lm or 1200lm - 2700K/3000K - DIM2/DIM3



Collezione / Collection



242



346

MEDEA
design Oriano Favaretto 2019





Medea SP 2 / 3 / 1



MEDEA SP 1

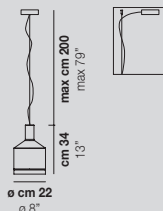

1x14W LED 04



USA & CANADA

1x14W LED 04

MEDEA SP 2

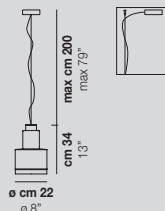

1x14W LED 04



USA & CANADA

1x14W LED 04

MEDEA SP 3

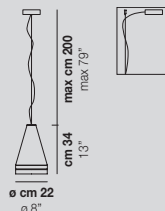

1x14W LED 04



USA & CANADA

1x14W LED 04

La collezione Medea si distingue per le sue forme geometriche e semplici. La sorgente LED illumina il piano e nello stesso tempo il vetro, portando a soffitto una parte di luce dalle tinte dolci. Presentate in gruppo o singolarmente manifestano un forte carattere stilistico quasi a divenire sculture.

The Medea collection is characterized by geometric and simple shapes. The LED source illuminates the surface and the glass at the same time, bringing towards the ceiling a part of the soft-colour light. Mounted in clusters or individually, they show a strong stylistic character, and almost become sculptures.

Finitura vetro / Glass finish



BC/SF



CR/TR



FU/TR

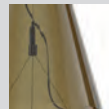

VA/TR

SP 1 solo BC/SF, CR/TR / SP 1 only BC/SF, CR/TR

SP 2 solo BC/SF, FU/TR / SP 2 only BC/SF, FU/TR

SP 3 solo BC/SF, VA/TR / SP 3 only BC/SF, VA/TR

Finitura struttura / Frame finish

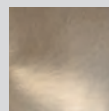

AVS

LED Europe/International 

04 14W - 28V - 2000lm - 2700K/3000K - DIM2/DIM3

LED Usa & Canada

04 14W - 28V - 2000lm - 2700K/3000K - DIM2/DIM3



MEDEA 2020

STONE

design Hangar Design Group 2017



Stone SP





Stone SP

STONE SP

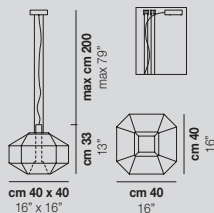

1x2W+1x8W LED 12



USA & CANADA .cULus

1x2W+1x8W LED 12

Stone è caratterizzata da volumi quasi scolpiti, dove la leggerezza del vetro soffiato si oppone alla solidità di geometrie lineari. In questo contrappunto, tra l'utilizzo di un materiale che naturalmente tende alla forma tonda e un design rigoroso che impone spigoli e linee ortogonali, si esprime l'equilibrio di una composizione luminosa di carattere, inedita. Sorgente luminosa a LED.

Stone is characterized by almost sculpted volumes, where the lightness of blown glass contrasts with the solidity of linear geometries. In this counterpoint, between the use of a material naturally tending to round shapes, and a rigorous design requiring edges and orthogonal lines, the balance of a bright, original composition is expressed. LED light source.

Finitura vetro / Glass finish

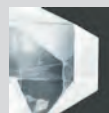

CR/BC



FU/BC

Finitura struttura / Frame finish

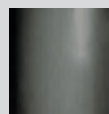

NN

LED Europe/International CE ENEC RoHS

12 2W+8W - 29V - 1000lm/1200lm - 2700K/3000K - DIM2/DIM3

LED Usa & Canada

12 2W+8W - 29V - 1000lm/1200lm - 2700K/3000K - DIM2/DIM3

**GOOD
DESIGN
AWARD
2017**

ASSIBA

design Mauro Olivieri 2011



Assiba SP 6

ASSIBA SP G

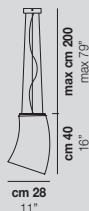

1x77W E27



USA & CANADA .E14.us

1x60W E26

ASSIBA SP 2

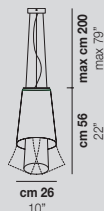

1x77W E27



USA & CANADA .E14.us

1x60W E26

ASSIBA SP 6

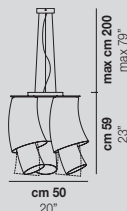

3x77W E27



USA & CANADA .E14.us

3x60W E26

La collezione è composta da due cilindri in vetro disponibili color bianco o cristallo trasparente con lavorazione "balloton". I due elementi sono rotanti e possono essere orientati in direzioni diverse permettendo così composizioni sempre diverse e uniche.

The collection is composed of two glass cylinders available in white or transparent "balloton" crystal. The two elements are rotating and can be oriented in different directions, thus allowing always different and unique compositions.

Finitura vetro / Glass finish

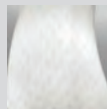

BC/BT



CR/BT



MC/2



MC/3

Finitura struttura / Frame finish

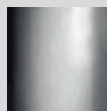

CR



Collezione / Collection



359

ARMONIA

design Francesco Lucchese 2019



Armonia SP 50



Armonia SP 50



ARMONIA SP 50

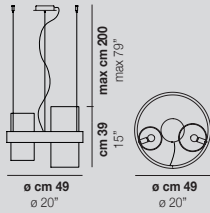

2x60W E14



USA & CANADA



2x40W E12



Una collezione dai connotati contemporanei che racchiude preziosi contenuti storici della lavorazione del vetro quali il "balloton" e il rigadin dritto e ritorto.

A collection with contemporary connotations that contains precious historical features: that of glass processings such as the "balloton" and the straight and twisted rigadin.

Finitura vetro / Glass finish

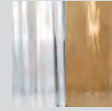

CR

vetro medio: cristallo rigadin verticale
medium glass: crystal striped vertical glass

AM

vetro grande: ambra "balloton"
big glass: amber "balloton"

CR/AM

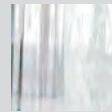

CR

vetro medio: cristallo rigadin verticale
medium glass: crystal striped vertical glass

CR

vetro grande: cristallo "balloton"
big glass: crystal "balloton"

CR/CR

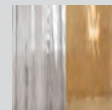

FU

vetro medio: fumè rigadin verticale
medium glass: smoky striped vertical glass

AM

vetro grande: ambra "balloton"
big glass: amber "balloton"

FU/AM

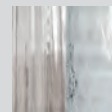

FU

vetro medio: fumè rigadin verticale
medium glass: smoky striped vertical glass

CR

vetro grande: cristallo "balloton"
big glass: crystal "balloton"

FU/CR

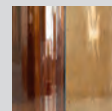

TB

vetro medio: terra bruciata rigadin verticale
medium glass: burned earth striped vertical glass

AM

vetro grande: ambra "balloton"
big glass: amber "balloton"

TB/AM

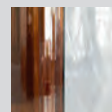

TB

vetro medio: terra bruciata rigadin verticale
medium glass: burned earth striped vertical glass

CR

vetro grande: cristallo "balloton"
big glass: crystal "balloton"

TB/CR

Finitura struttura / Frame finish

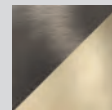

N_O



N_R

Collezione / Collection

Q
300



ARMONIA 2020

DIAMANTE

design Barbara Maggiolo 2003



Diamante SP 1





Diamante SP 36

DIAMANTE SP P

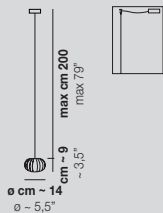

1x60W G9 / **LED B**
CE **CB ENEC**
USA & CANADA
 1x60W G9 / **LED B**

DIAMANTE SP G

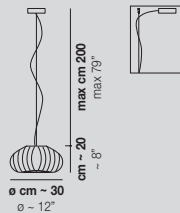

1x77W E27 / **LED C**
CE **CB ENEC**
USA & CANADA
 1x60W E26 / **LED C**

DIAMANTE SP 36

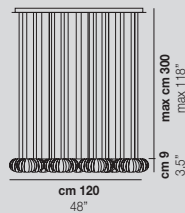

36x60W G9
CE **ENE**
USA & CANADA
 36x60W G9

La collezione Diamante nasce da un processo esclusivamente artigianale. La particolare lavorazione viene esaltata dalla nuova versione LED. Le sospensioni presentate assieme o singolarmente donano all'ambiente un tocco raffinato.

The Diamante collection is the result of an exclusively artisanal process. The artisan manufacture is enhanced by the new LED version. The suspensions, presented as a cluster or individually, give the room a refined touch.

Finitura vetro / Glass finish



AM



CR

Finitura struttura / Frame finish

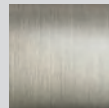

NI

LED Europe/International



- B** 9W - 34V - 1100lm/1200lm - 2700K/3000K - DIM2/DIM3
- C** 12W - 35V - 1500lm/1600lm - 2700K/3000K - DIM2/DIM3

LED Usa & Canada



- B** 9W - 34V - 1100lm/1200lm - 2700K/3000K - DIM2/DIM3
- C** 12W - 35V - 1500lm/1600lm - 2700K/3000K - DIM2/DIM3

Collezione / Collection



270

BOLLE

design Barbara Maggiolo 2009



Bolle SP 35

BOLLE SP P

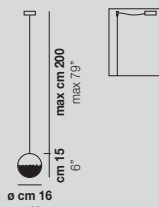

1x60W G9 / **LED B**
 CE
 USA & CANADA
 1x60W G9 / **LED B**

BOLLE SP G

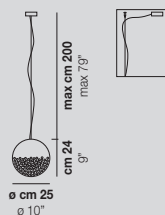

1x77W E27 / **LED C**
 CE
 USA & CANADA
 1x60W E26 / **LED C**

BOLLE SP 35

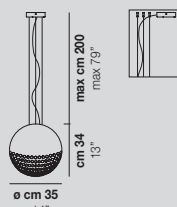

1x77W E27 / **LED C**
 CE
 USA & CANADA
 1x60W E26 / **LED C**

La caratteristica texture di questa collezione viene dalla tecnica "balloton", che consiste nell'inserimento di bolle d'aria nel vetro durante la lavorazione. L'effetto "tessuto" che si ottiene moltiplica i riflessi sulla superficie della sfera.

The main characteristic of this collection of lamps produced with the "balloton" technique is the insertion of bubbles of air in the glass during its production. That creates multiple reflections and adds an organic texture on the surface of the sphere.

Finitura vetro / Glass finish



BC/BO

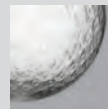

CR/BO

Finitura struttura / Frame finish

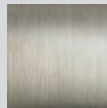

NI

LED Europe/International

- B** 9W - 34V - 1100lm/1200lm - 2700K/3000K - DIM2/DIM3
- C** 12W - 35V - 1500lm/1600lm - 2700K/3000K - DIM2/DIM3

LED Usa & Canada

- B** 9W - 34V - 1100lm/1200lm - 2700K/3000K - DIM2/DIM3
- C** 12W - 35V - 1500lm/1600lm - 2700K/3000K - DIM2/DIM3



Collezione / Collection



244



364

24PEARLS

design Romani Sacconi Architetti Associati 2009



24Pearls SP

24PEARLS SP

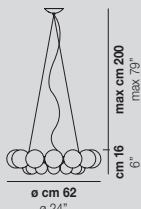

12x33W G9



USA & CANADA

12x33W G9

Caratterizzano questa collezione due corolle di sfere in vetro soffiato nei colori bianco e cromato, disposte sugli anelli della montatura a due livelli, per creare un caleidoscopico effetto di luce e riflessi.

The collection is characterised by two corollas of blown glass spheres in white and chrome, which are arranged on the rings of the frame at two levels to create a kaleidoscopic effect of light and reflection.

Finitura vetro / Glass finish



BC/CM

Finitura struttura / Frame finish



CR

ARIA

design Giovanni Barbato 2017



Aria SP

ARIA SP

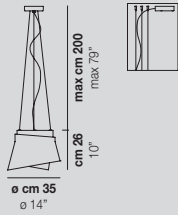

1×77W E27



USA & CANADA 

1×60W E26

Due vetri semplicemente appoggiati a un anello rendono la montatura elemento significativo e caratterizzante della lampada, valorizzando la leggerezza del vetro. I tagli inclinati dei vetri permettono infinite composizioni.

Two glasses simply fixed on a ring make the frame a significant feature of the lamp and give more value to the lightness of the glass. Sloping glass cuts allow for countless compositions.

Finitura vetro / Glass finish



BC/CM

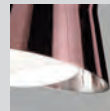

BC/RA

Finitura struttura / Frame finish

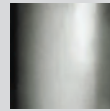

NL



CRISTALLINA

design Romani Sacconi Architetti Associati 2017



Cristallina SP

CRISTALLINA SP

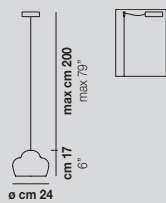

1x8,5W LED 01

CE EAC

USA & CANADA 

1x8,5W LED 01

La collezione è caratterizzata dalla forma del paralume bombato sulla sommità e dalle particolari sfumature del cristallo. Ciò permette alla luce di irradiarsi e diffondersi in modo confortevole nell'ambiente. Sorgente luminosa a LED.

This collection is characterized by the shape of the lampshade rounded at the top and by the special shades of crystal. That allows the light to spread and create a comfortable atmosphere. LED light source.

Finitura vetro / Glass finish



BC/SF



NE/SF

Finitura struttura / Frame finish

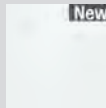

BO

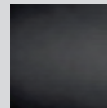

NEO

LED Europe/International 

01 8,5W - 24V - 1200lm - 2700K/3000K - DIM2/DIM3

LED Usa & Canada 

01 8,5W - 24V - 1200lm - 2700K/3000K - DIM2/DIM3



POC

design Barbara Maggiolo 2003

Poc SP 16

126



POC SP 16

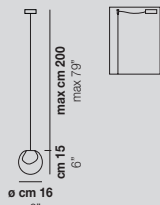

1×60W G9 / LED B



USA & CANADA

1×60W G9 / LED B

POC SP 25

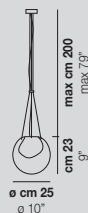

1×60W G9



USA & CANADA

1×60W G9

L'esclusivo impiego della membrana interna nella collezione Poc genera, come una lente, l'effetto di una sfera composta da due metà. La resa di ogni membrana è diversa, creando per ciascun pezzo dinamiche variazioni di intensità di luce e colore sulla superficie.

The unique use of the inner membrane in the Poc collection generates, like a lens, the effect of a sphere composed of two halves. The rendering of each membrane is different, creating for each piece dynamic variations of light intensity and colour on the surface.

Finitura vetro / Glass finish



CR/BC

Finitura struttura / Frame finish

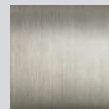

NI



LED Europe/International 

B 9W - 34V - 1100lm/1200lm - 2700K/3000K - DIM2/DIM3

LED Usa & Canada 

B 9W - 34V - 1100lm/1200lm - 2700K/3000K - DIM2/DIM3

Collezione / Collection



269



ORO SP P

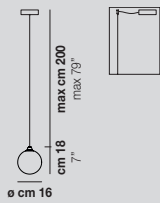

1×60W G9 / LED B



USA & CANADA



1×60W G9 / LED B

L'utilizzo della membrana interna orizzontale divide la sfera di cristallo trasparente in due metà. La lavorazione artigianale della membrana rende ogni pezzo unico variando a seconda della curvatura della membrana il contributo sulla superficie. Parti metalliche nickel nero o ottone lucido.

The use of the horizontal inner membrane divides the transparent glass into two halves. The artisanal processing of the membrane makes each piece unique by varying the effect on the surface depending on the curvature of the membrane. Black nickel or glossy brass metal parts.

Finitura vetro / Glass finish



CR/BC



CR/TR

Finitura struttura / Frame finish

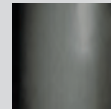

NN

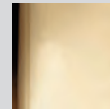

OG

LED Europe/International



B 9W - 34V - 1100lm/1200lm - 2700K/3000K - DIM2/DIM3

LED Usa & Canada



B 9W - 34V - 1100lm/1200lm - 2700K/3000K - DIM2/DIM3



IMPLODE

design Gregorio Spini 2011



Implode SP 50

IMPLODE SP 16

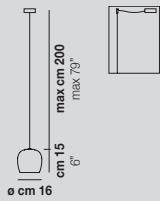

1×60W G9 / **LED B**
CE **CB ENEC**
USA & CANADA
 1×60W G9 / **LED B**

IMPLODE SP 50

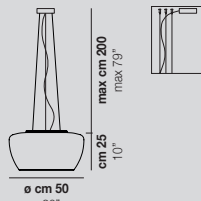

3×77W E27 / **LED O**
CE **CB ENEC**
USA & CANADA
 3×60W E26 / **LED O**

Questa linea rappresenta l'illusione di una superficie creata dall'implosione di un volume. Il vetro, grazie alla sua densità, lascia trasparire le gradazioni di strati multipli di cristallo bianco e trasparente.

A collection that represents the illusion of a surface created by the implosion of a volume. The glass, due to its thickness, shows a gradation of multiple layers of white and transparent crystal.

Finitura vetro / Glass finish



BC/CR

Finitura struttura / Frame finish



BC



BO*

LED version: BO*

LED Europe/International **CE ENEC**

B 9W - 34V - 1100lm/1200lm - 2700K/3000K - DIM2/DIM3

O 26W - 39V - 3700lm - 2700K/3000K - DIM2/DIM3

LED Usa & Canada

B 9W - 34V - 1100lm/1200lm - 2700K/3000K - DIM2/DIM3

O 26W - 39V - 3700lm - 2700K/3000K - DIM2/DIM3



SP 16

Collezione / Collection



248

BOT

design Gregorio Spini 2011



Bot SP 35

BOT SP 16

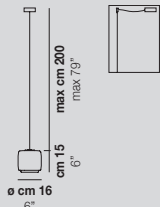

1x60W G9



USA & CANADA

1x60W G9

BOT SP 35

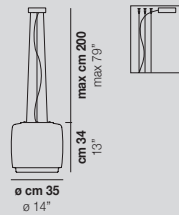

3x77W E27 / LED G



USA & CANADA

3x60W E26 / LED G

BOT SP 45

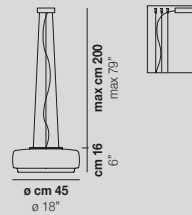

2x77W E27 / LED G



USA & CANADA

2x60W E26 / LED G

Un volume in movimento che ne genera uno nuovo è il concetto rappresentato dalla collezione Bot che allo stesso tempo richiama il processo della soffiatura del vetro, in cui il materiale incandescente contiene la luce, prima ancora di avere una forma definitiva.

A collection that represents the idea of a volume in motion generating a new one. The concept is also a reminiscence of the process of glass blowing in which the incandescent glass contains light even before it has a definite form.

Finitura vetro / Glass finish



BC/CR

Finitura struttura / Frame finish



BC

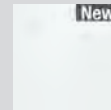

BO*

LED version: BO*

LED Europe/International



G 19W - 39V - 2850 lm - 2700K/3000K - DIM2/DIM3

LED Usa & Canada



G 19W - 39V - 2850 lm - 2700K/3000K - DIM2/DIM3



Collezione / Collection



246

SEMAI

design Alberto Saggia e Valerio Sommella 2015



Semai SP P / M

SEMAI SP P

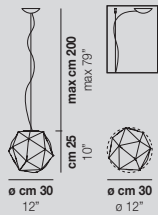

1×77W E27



USA & CANADA .E14

1×60W E26

SEMAI SP M

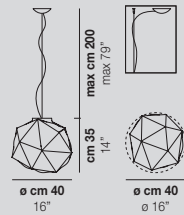

1×77W E27



USA & CANADA .E14

1×60W E26

Collezione di lampade in vetro soffiato a bocca all'interno di una gabbia di acciaio. La tecnica di soffiaggio libera rende ciascuna lampada sempre diversa. Vetro bianco lucido. Gabbia inox scuro.

Collection of lamps made of a mouth-blown glass into a steel cage. This free blowing technique makes each lamp always different. Glossy white glass. Dark inox cage.

Finitura vetro / Glass finish



BC/LU

Finitura struttura / Frame finish



BC



Collezione / Collection



250

NEOCHIC
design Chiaramonte & Marin 2013



Neochic SP P / M / G / R





Neo chic SP M

NEOCHIC SP P

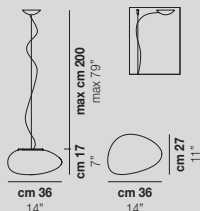

1x77W E27 / **LED F**
 CE
 USA & CANADA
 1x60W E26 / **LED F**

NEOCHIC SP M

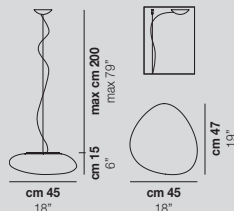

2x77W E27 / **LED G**
 CE
 USA & CANADA
 2x60W E26 / **LED G**

NEOCHIC SP G

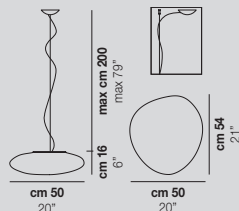

2x77W E27 / **LED G**
 CE
 USA & CANADA
 2x60W E26 / **LED G**

Le curve morbide e la superficie levigata incontrano il vetro soffiato in un modello di estrema semplicità, adatto a qualsiasi contesto d'arredo.

Soft curves and a polished surface meet blown glass in a model of extreme simplicity, suitable for any context.

Finitura vetro / Glass finish

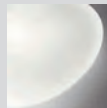

BC/ST

Finitura struttura / Frame finish



NIB



BO*

LED version: BO*

NEOCHIC SP R

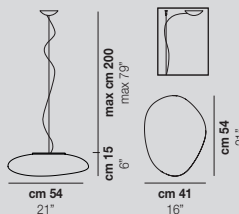

2x77W E27 / **LED G**
 CE
 USA & CANADA
 2x60W E26 / **LED G**



LED Europe/International

F 12W - 24V - 1700 lm - 2700K/3000K - DIM2/DIM3

G 19W - 39V - 2850 lm - 2700K/3000K - DIM2/DIM3

LED Usa & Canada

F 12W - 24V - 1700 lm - 2700K or 3000K - DIM2 or DIM3

G 19W - 39V - 2850 lm - 2700K or 3000K - DIM2 or DIM3

Collezione / Collection



236



294

LUCCIOLA

archivio storico Vetreria Vistosi 1981



Lucciola SP G

LUCCIOLA SP 18

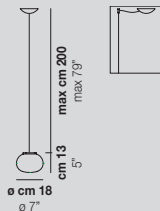

1x46W E14
CE **CB ENEC ETC**
USA & CANADA

LUCCIOLA SP 27

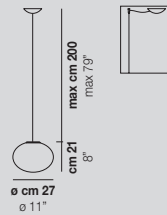

1x46W E14
CE **CB ENEC ETC**
USA & CANADA

LUCCIOLA SP P

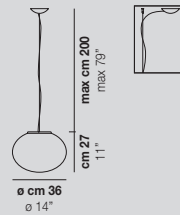

1x77W E27 / **LED F**
CE **CB ENEC ETC**
USA & CANADA
 1x60W E26 / **LED F**

LUCCIOLA SP M

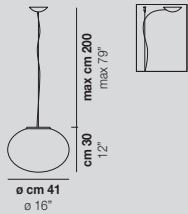

3x77W E27 / **LED F**
CE **CB ENEC ETC**
USA & CANADA
 3x60W E26 / **LED F**

LUCCIOLA SP G

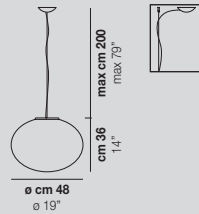

3x77W E27 / **LED F**
CE **CB ENEC ETC**
USA & CANADA
 3x60W E26 / **LED F**

Una delle più versatili collezioni. La sua forma ovale in vetro soffiato satinato è disponibile in diverse dimensioni, che si prestano a innumerevoli combinazioni d'installazione.

One of our most versatile collections. The oval and mouth-blown satin glass shape is available in different sizes, which can be combined to offer countless installation combinations.

Finitura vetro / Glass finish



BC/ST

Finitura struttura / Frame finish



BC

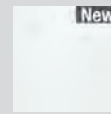

BO*

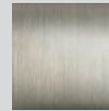

NI

LED version: BO*

LED Europe/International **CE ENEC**

F 12W - 24V - 1700lm - 2700K/3000K - DIM2/DIM3

LED Usa & Canada

F 12W - 24V - 1700lm - 2700K/3000K - DIM2/DIM3



Collezione / Collection



266

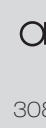

308



354



384

SURFACE

design Giovanni Barbato 2017



Surface SP G

SURFACE SP G

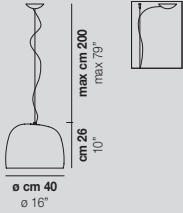

1x77W E27 / LED C



USA & CANADA .cULus

1x60W E26 / LED C

Surface ridefinisce il concetto di superficie: un'estensione del vetro la cui forma è in continuo mutamento. Generata dall'unione e dall'intersezione di due solidi in rotazione, assume figure diverse a seconda del punto di vista, lasciando all'osservatore il compito di interpretarlo e reinterpretarlo volta per volta.

Surface redefines the concept of surface: an extension of glass whose shape is constantly changing. The light source, which is generated by the union and intersection of two solids of revolution, takes different shapes depending on the observers' point of view, thus letting them interpret it over and over again.

Finitura vetro / Glass finish



BC/BC



BC/FU



BC/TB



BC/VA

Finitura struttura / Frame finish

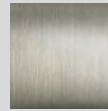

NI

LED Europe/International



C 12W - 35V - 1500lm/1600lm - 2700K/3000K - DIM2/DIM3

LED Usa & Canada



C 12W - 35V - 1500lm/1600lm - 2700K/3000K - DIM2/DIM3

BALANCE
design Pio e Tito Toso 2011



BALANCE SP 24

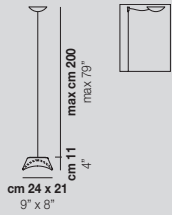

1x46W E14
CE **CB ENEC**
USA & CANADA
 1x40W E12

BALANCE SP M

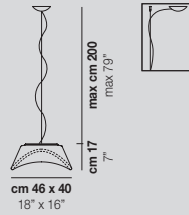

2x77W E27 / **LED G**
CE **CB ENEC**
USA & CANADA
 2x60W E26 / **LED G**

BALANCE SP G

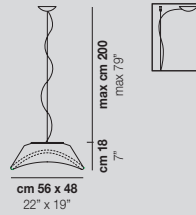

2x77W E27 / **LED G**
CE **CB ENEC**
USA & CANADA
 2x60W E26 / **LED G**

La traiettoria delle orbite planetarie intorno al sole ispira questa collezione, che ripropone il movimento creato dall'armonia e dall'equilibrio di forze invisibili con vetro e luce. Disponibile in tre dimensioni.

The elliptical orbit of a planet around the sun inspires this collection, which reminds of the movement created by the harmony and balance of invisible forces with glass and light. Available in three sizes.

Finitura vetro / Glass finish

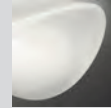

BO/LU

Finitura struttura / Frame finish

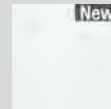

BO*



NIB

LED version: BO*

LED Europe/International **CE ENEC**
G 19W - 39V - 2850 lm - 2700K/3000K - DIM2

LED Usa & Canada
G 19W - 39V - 2850 lm - 2700K/3000K - DIM2



Collezione / Collection



232



306

INFINITA

design Renato Toso, Noti Massari & Associati 2009



Infinita SP 80

INFINITA SP 36

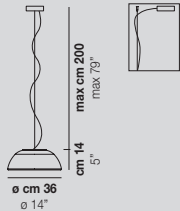

1x77W E27 / **LED F**
CE **CB ENEC**
USA & CANADA
 1x60W E26 / **LED F**

INFINITA SP 53

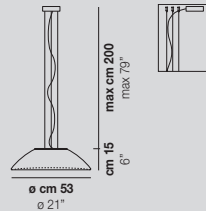

2x77W E27 / **LED G**
CE **CB ENEC**
USA & CANADA
 2x60W E26 / **LED G**

INFINITA SP 80

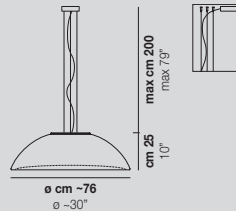

5x77W E27 / **LED O**
CE **CB ENEC**
USA & CANADA
 5x60W E26 / **LED O**

In versione sospensione, soffitto o parete, è la risposta perfetta per chi cerca una lampada dalle grandi dimensioni. Il diffusore soprattutto nella dimensione più grande offre un'ampia superficie nonostante una montatura metallica essenziale.

Available as pendant, ceiling or wall lamp. It is the perfect answer for those looking for a large lamp. The diffuser, especially in the bigger size, offers a large lighting surface area despite a minimalist metal frame.

Finitura vetro / Glass finish



BC/ST

Finitura struttura / Frame finish



BC

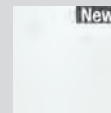

BO*

LED version: BO*

LED Europe/International **CE ENEC**

- F** 12W - 24V - 1700 lm - 2700K/3000K - DIM2/DIM3
- G** 19W - 39V - 2850 lm - 2700K/3000K - DIM2/DIM3
- O** 26W - 39V - 3700 lm - 2700K/3000K - DIM2/DIM3

LED Usa & Canada

- F** 12W - 24V - 1700 lm - 2700K/3000K - DIM2/DIM3
- G** 19W - 39V - 2850 lm - 2700K/3000K - DIM2/DIM3
- O** 26W - 39V - 3700 lm - 2700K/3000K - DIM2/DIM3



Collezione / Collection



234

NAXOS

archivio storico Vetreria Vistosi 1988



Naxos SP 50

NAXOS SP 50

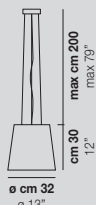

3x77W E27



USA & CANADA

3x60W E26

NAXOS SP 76

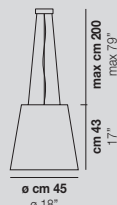

3x77W E27



USA & CANADA

3x60W E26

Collezione di lampade dal design senza tempo, che esalta la qualità del vetro satinato. La versione da tavolo sfrutta il vantaggio di due sorgenti luminose: la base e il paralume.

A collection of lamps with a timeless design that maximizes the quality of the satin-finished glass. The table versions have a double light source: the shade and the base.

Finitura vetro / Glass finish

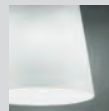

BC/ST

Finitura struttura / Frame finish

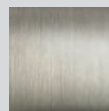

NI

Collezione / Collection



362

385

BACO
design Mauro Olivieri 1998



Baco SP 5M1

BACO SP P

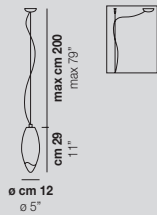

1x70W E27



USA & CANADA

1x60W E26

BACO SP G

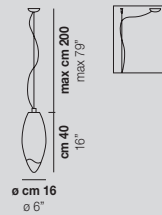

1x70W E27



USA & CANADA

1x60W E26

BACO SP 5M1

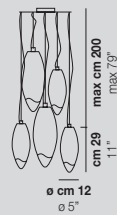

5x70W E27



USA & CANADA

5x60W E26

Esclusiva sospensione a forma di lacrima, soffiata a bocca con una tecnica che trascolora il vetro di Murano dai toni del bianco al trasparente. Disponibile in due misure.

Unique teardrop-shaped pendant light, mouth-blown with a technique that transforms Murano glass from white to transparent. Available in two sizes.

Finitura vetro / Glass finish

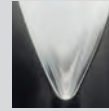

BC/SF

Finitura struttura / Frame finish

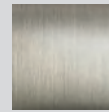

NI

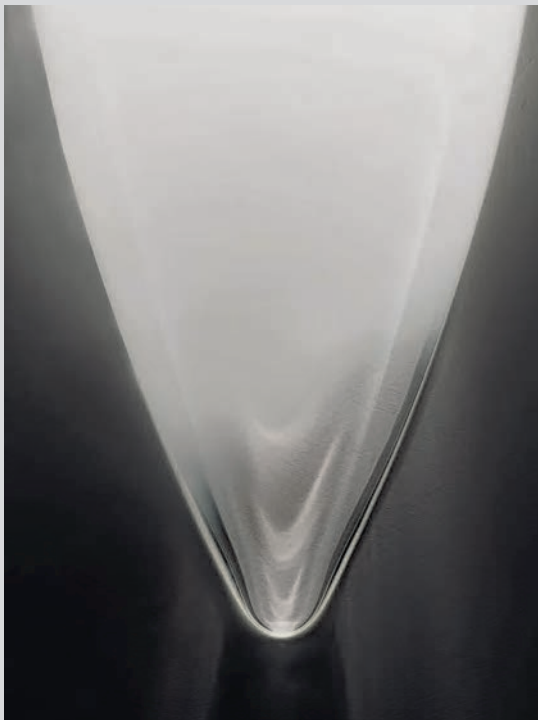

NARANZA

archivio storico Vetreria Vistosi 1965 - restyling 2007



Naranza SP G

NARANZA SP P

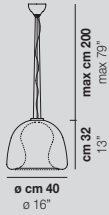

1×77W E27



USA & CANADA 

1×60W E26

NARANZA SP G

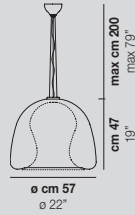

1×77W E27



USA & CANADA 

1×60W E26

Sospensione realizzata dall'accoppiamento di due componenti in vetro che richiedono estrema maestria nella soffiatura e nel taglio.

This suspension is made of two glass components requiring extreme skill in blowing and cutting.

Finitura vetro / Glass finish



BC/LU

Finitura struttura / Frame finish

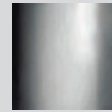

CR

DRESS

studio tecnico Vetreria Vistosi 2005



Dress SP G

DRESS SP G

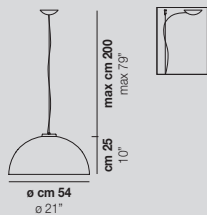

1x77W E27 / **LED C**



USA & CANADA 

1x60W E26 / **LED C**

Il design essenziale di Dress la rende adatta a qualsiasi ambiente. Disponibile in versione sospensione con finitura bianco lucido.

The essential design of Dress makes it suitable for any contemporary environment. Available as suspension with glossy white glass finish.

Finitura vetro / Glass finish



BC/LU

Finitura struttura / Frame finish

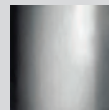

CR

LED Europe/International



C 12W - 35V - 1500lm/1600lm - 2700K/3000K - DIM2/DIM3

LED Usa & Canada

C 12W - 35V - 1500lm/1600lm - 2700K/3000K - DIM2/DIM3

NINFEA

design Oriano Favaretto 2009



NINFEA SP P

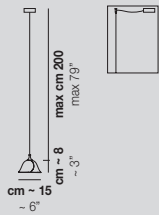

1x60W G9



USA & CANADA .E14

1x60W G9

NINFEA SP G

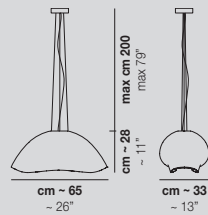

1x77W E27



USA & CANADA .E27

1x60W E26

Design elegante e produzione artigianale che esaltano al massimo le caratteristiche del vetro Muranese. Una collezione versatile che si adatta a qualsiasi contesto d'arredo.

Elegant design and craftsmanship that enhance Murano glass properties. This collection is suitable for any context.

Finitura vetro / Glass finish

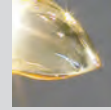

AM



BC/LU

Finitura struttura / Frame finish



CR



SP P

CLOTH

design Romani Saccani Architetti Associati 2009



Cloth SP G

CLOTH SP G

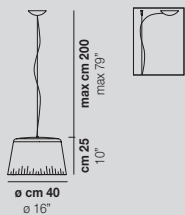

1x77W E27 / LED C



USA & CANADA

1x60W E26 / LED C

La complessa soffiatura di Cloth trasforma il vetro in un tessuto increspato, di grande effetto. Nella versione cromata, grazie ad un'esclusiva finitura esterna, Cloth è metallizzata quando è spenta, e assume un tono caldo beige scuro quando viene accesa.

A unique blown glass that seems to turn into pleated fabric, making this collection a real eye catcher. The chrome version has an exclusive outer chrome coating that looks metallic when the lamp is off, but turns to dark beige when the lamp is on.

Finitura vetro / Glass finish

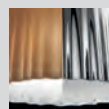

BC/CM

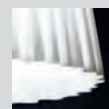

BC/ST

Finitura struttura / Frame finish

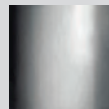

CR

LED Europe/International



C 12W - 35V - 1500lm/1600lm - 2700K/3000K - DIM2/DIM3

LED Usa & Canada



C 12W - 35V - 1500lm/1600lm - 2700K/3000K - DIM2/DIM3



OFF



ON

Collezione / Collection

317

MIRAGE

design Giovanni Barbato 2017



Mirage SP

MIRAGE SP

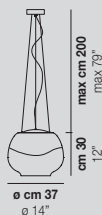

1x19,5W LED 07



USA & CANADA

1x19,5W LED 07

Il vetro soffiato restituisce alla luce il suo ruolo centrale, direzionandola e diffondendola nell'ambiente in modo confortevole, sottolineandone la luminosità. Sorgente luminosa LED.

The blown glass gives light its central role, directing and spreading it in the environment and emphasizing its brightness. LED lighting source.

Finitura vetro / Glass finish



BC/AM



BC/CR

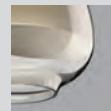

BC/FU

Finitura struttura / Frame finish



BC

LED Europe/International

07 19,5W - 39V - 2850 lm - 2700K/3000K - DIM2/DIM3

LED Usa & Canada

07 19,5W - 39V - 2850 lm - 2700K/3000K - DIM2/DIM3



NODO

design Pio e Tito Toso 2015



Nodo SP 25

NODO SP 25

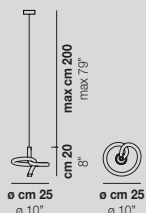

1x48W G9



USA & CANADA

1x48W G9

Elemento soffiato e lavorato a mano libera.
Illuminazione direzionale verso il basso e diffusa
nell'ambiente.

*Blown and freehand-worked element. Directional
lighting downward and widespread in the room.*

Finitura vetro / Glass finish



BC/LU

Finitura struttura / Frame finish

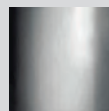

CR



STARDUST

design Francesco Lucchese 2015



Stardust SP DOP



Stardust SP R



Stardust SP Q

STARDUST SP

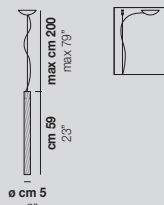

1x48W G9



USA & CANADA

1x48W G9

STARDUST SP DOP

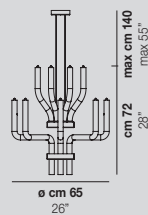

16x48W G9



USA & CANADA

16x48W G9

STARDUST SP Q

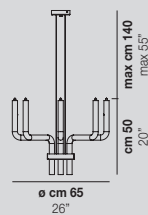

8x48W G9



USA & CANADA

8x48W G9

STARDUST SP R

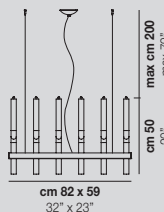

12x48W G9



USA & CANADA

12x48W G9

Collezioni di lampade con bracci in vetro soffiato e lavorato a mano. Le strutture in metallo nascondono un originale sistema di fissaggio dei bracci e del sistema di cablaggio.

Collections of lamps with arms made of blown and handcrafted crystal glass. The metal frames hide an original fastening system of the arms and of the cabling system.

Finitura vetro / Glass finish



CR/RI

Finitura struttura / Frame finish

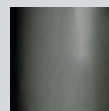

NN



Collezione / Collection



320

DAMASCO
design Paolo Crepax 2003



DAMASCO SP P

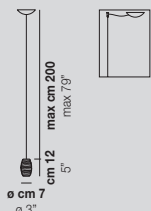

1x60W G9 / **LED A**
 CE
 USA & CANADA
 1x60W G9 / **LED A**

DAMASCO SP C

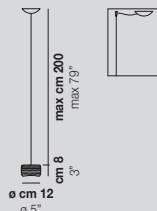

1x60W G9 / **LED B**
 CE
 USA & CANADA
 1x60W G9 / **LED B**

DAMASCO SP M

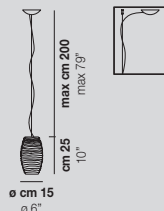

1x77W E27 / **LED C**
 CE
 USA & CANADA
 1x60W E26 / **LED C**

Collezione realizzata con la tecnica a bozzolo, in cui l'originale decoro diventa un vero e proprio materiale: la sovrapposizione di fili di vetro fuso a creare una texture in rilievo. Damasco è una delle creazioni di più lungo successo, che vede nel tempo versioni sempre nuove.

The collection is produced with the bozzolo technique: that consists in applying threads of molten glass to create an organic texture. Damasco is one of our most successful series, which has been developed and extended during the years with new versions.

DAMASCO SP G

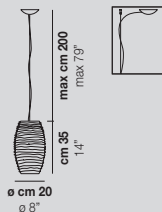

1x77W E27 / **LED C**
 CE
 USA & CANADA
 1x60W E26 / **LED C**

Finitura vetro / Glass finish

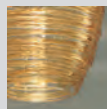

CR/AM



CR/CR

Finitura struttura / Frame finish

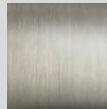

NI



LED Europe/International

- A 9W - 34V - 1100lm/1200lm - 2700K/3000K - DIM2/DIM3
- B 9W - 34V - 1100lm/1200lm - 2700K/3000K - DIM2/DIM3
- C 12W - 35V - 1500lm/1600lm - 2700K/3000K - DIM2/DIM3

LED Usa & Canada

- A 9W - 34V - 1100lm/1200lm - 2700K/3000K - DIM2/DIM3
- B 9W - 34V - 1100lm/1200lm - 2700K/3000K - DIM2/DIM3
- C 12W - 35V - 1500lm/1600lm - 2700K/3000K - DIM2/DIM3

Collezione / Collection





Damasco SP 6 P

DAMASCO SP 6 P

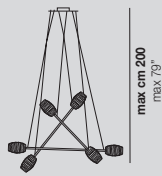

6x60W G9



USA & CANADA

6x60W G9

Collezione realizzata con la tecnica a bozzolo, in cui l'originale decoro diventa un vero e proprio materiale: la sovrapposizione di fili di vetro fuso a creare una texture in rilievo. Damasco è una delle creazioni di più lungo successo, che vede nel tempo versioni sempre nuove.

The collection is produced with the bozzolo technique: that consists in applying threads of molten glass to create an organic texture. Damasco is one of our most successful series, which has been developed and extended during the years with new versions.

Finitura vetro / Glass finish

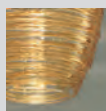

CR/AM



CR/CR

Finitura struttura / Frame finish

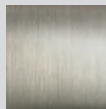

NI



Collezione / Collection



268



318



365



388

STARNET

design Gianni Veneziano e Luciana Di Virgilio | Veneziano+Team 2015



Starnet SP 5



Starnet SP 3



STARNET SP 3

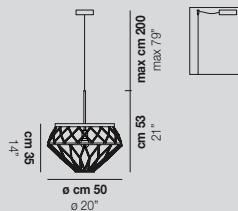

1x77W E27



USA & CANADA

1x60W E26

STARNET SP 4

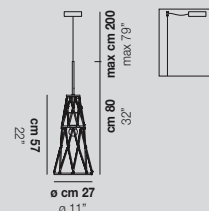

1x77W E27



USA & CANADA

1x60W E26

STARNET SP 5

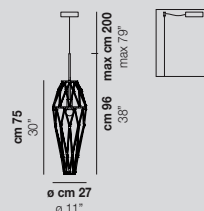

1x77W E27



USA & CANADA

1x60W E26

Starnet è un prodotto versatile costituito da infinite trame di cristallo che permettono grandi possibilità di personalizzazione. La sospensione è disponibile in tre diverse configurazioni. Le finiture metalliche oro satinato o nero opaco esaltano il vetro cristallo trasparente.

Starnet is a versatile product, consisting of infinite crystal textures that allow great possibilities for customization. The suspension is available in three different models. Matt gold or black metal parts finishes enhance the transparent crystal glass.

Finitura vetro / Glass finish

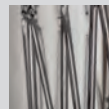

CR

Finitura struttura / Frame finish

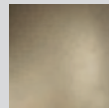

BKS

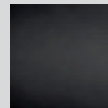

NEO



KIRA

design Alberto Saggia e Valerio Sommella 2017



Kira SP P

KIRA SP P

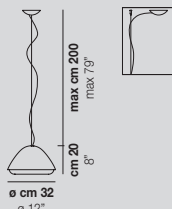

1x77W E27 / LED C



USA & CANADA 

1x60W E26 / LED C

Kira combina il vetro soffiato con il metallo. Il risultato è una sospensione composta da due metà antitetiche: un diffusore in vetro cristallo, decorato e impreziosito da una ricca texture superficiale, sormontato da un cappello in metallo tornito, dall'aspetto più minimale e pulito. Questa collezione combina forme contemporanee alla preziosità e allo sfarzo luminoso del cristallo dei classici lampadari veneziani.

Kira combines metal with blown glass. The result is a suspension composed by two antithetical halves: a diffuser in crystal glass, decorated and embellished with a rich surface texture, topped with a turned metal cap, with a minimal and simple look. This collection combines contemporary forms to the preciousness and brightness of classical Venetian crystal chandeliers.

Finitura vetro / Glass finish



CR/BT

Finitura struttura / Frame finish

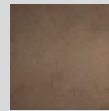

BV

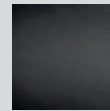

NEO



OT



LED Europe/International 

C 12W - 35V - 1500lm/1600lm - 2700K/3000K - DIM2/DIM3

LED Usa & Canada 

C 12W - 35V - 1500lm/1600lm - 2700K/3000K - DIM2/DIM3

LIO

archivio storico Vetreria Vistosi 1972



Lio SP 5

LIO SP 1 P

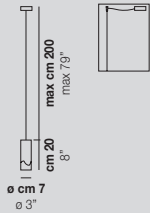

1x60W G9 / **LED A**
CE **ErC** **CB** **ErC** **CCC**
USA & CANADA **UL**
 1x60W G9 / **LED A**

LIO SP

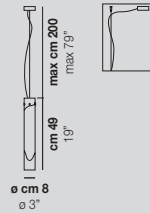

1x77W E27 / **LED C**
CE **ErC** **CCC** **PS**
USA & CANADA **UL**
 1x60W E26 / **LED C**

LIO SP 5

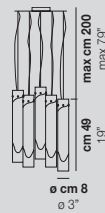

5x77W E27
CE **ErC** **CCC**
USA & CANADA **UL**
 5x60W E26

Collezione dal design minimalista e discreto che esalta la sorgente luminosa, grazie alla fascia di vetro traslucida imprigionata tra gli strati del cristallo.

The minimal and unobtrusive design of this collection enhances the light source thanks to the translucent glass band trapped between the crystal layers.

Finitura vetro / Glass finish



CR/BC

Finitura struttura / Frame finish

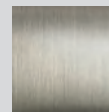

NI

LED Europe/International **CE ErC**

- A** 9W - 34V - 1100lm/1200lm - 2700K/3000K - DIM2/DIM3
- C** 12W - 35V - 1500lm/1600lm - 2700K/3000K - DIM2/DIM3

LED Usa & Canada **UL**

- A** 9W - 34V - 1100lm/1200lm - 2700K/3000K - DIM2/DIM3
- C** 12W - 35V - 1500lm/1600lm - 2700K/3000K - DIM2/DIM3

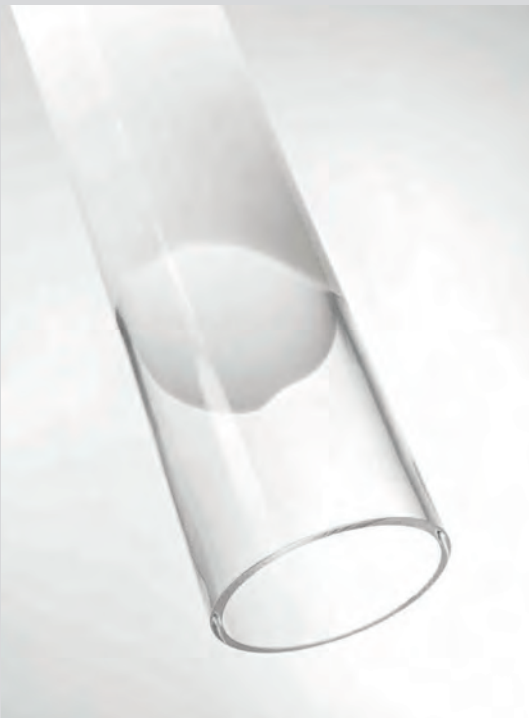

Collezione / Collection



256

322

358

SISSI

design Barbara Maggiolo 2009



SISSI SP

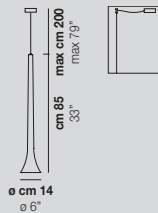

1x75W GU10



USA & CANADA 

1x75W GU10

Un punto di luce verticale, tecnico, dalle forme sinuose e allungate realizzato da un unico elemento in vetro soffiato.

A vertical, technical and elegant light made from a single blown glass element.

Finitura vetro / Glass finish



BC/LU

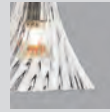

CR/RI

Finitura struttura / Frame finish

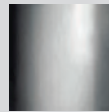

CR



LACRIMA
design Paolo Crepax 2003

Lacrime SP G



LACRIMA SP P

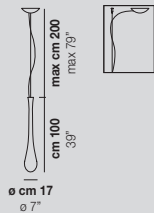

1x77W E27 / LED C



USA & CANADA

1x60W E26 / LED C

LACRIMA SP G

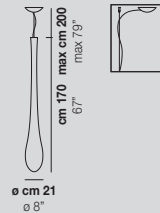

1x77W E27 / LED C



USA & CANADA

1x60W E26 / LED C

Realizzata in due dimensioni, grazie alla forma di goccia allungata, Lacrima è la soluzione ideale per vani scale e soffitti alti.

Available in two sizes, thanks to its long teardrop shape, Lacrima is the ideal solution for staircases or high ceilings.

Finitura vetro / Glass finish

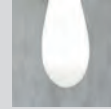

BC/LU

Finitura struttura / Frame finish

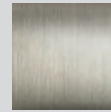

NI

LED Europe/International

C 12W - 35V - 1500lm/1600lm - 2700K/3000K - DIM2/DIM3

LED Usa & Canada

C 12W - 35V - 1500lm/1600lm - 2700K/3000K - DIM2/DIM3



TUBES

design Matthias Hickl per Lissoni Associati 2005



Tubes SP 40 / 60 / 90 / 120

TUBES SP 20

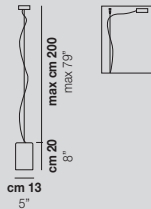

1x77W E27



USA & CANADA 

1x60W E26

TUBES SP 40

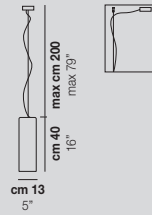

1x77W E27



USA & CANADA 

1x60W E26

TUBES SP 60

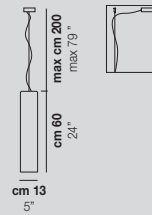

1x77W E27



USA & CANADA 

1x60W E26

TUBES SP 90

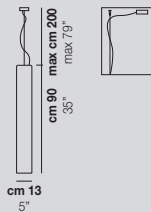

1x77W E27



USA & CANADA 

1x60W E26

TUBES SP 120

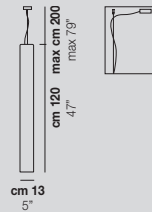

1x77W E27



USA & CANADA 

1x60W E26

Una serie di cinque elementi lineari di diversa lunghezza in vetro soffiato, che si possono usare come singole sospensioni, lampade a soffitto o in combinazioni multiple.

A series of five elements of straight lines in different lengths, made of mouth-blown glass, which can be used as standalone pendants and ceiling fixtures or in multiple combinations.

Finitura vetro / Glass finish



BC/LU

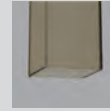

FU/TR

Finitura struttura / Frame finish

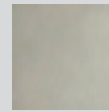

NO



Collezione / Collection



272

LEPANTO
design Luciano Vistosi 1968



Lepanto SP

LEPANTO SP

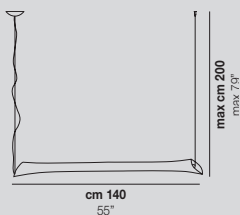

1x18W G5 LED



USA & CANADA

1x18W G5 LED

Lepanto è una vera scultura in vetro di Murano, che richiede grande abilità tecnica nella realizzazione. La finitura del vetro "pulegoso" che la caratterizza, trasforma la superficie in una raffinata texture naturale.

A light sculpture of classical inspiration made in Murano glass requiring a high degree of technical skill. The "pulegoso" finish adds a unique organic texture to the surface of the glass.

Finitura vetro / Glass finish

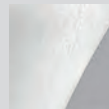

BC/PU

Finitura struttura / Frame finish

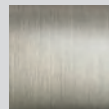

NI



Collezione / Collection



382

CANDELA

studio tecnico Vetreria Vistosi 2005



Candela SP

CANDELA SP

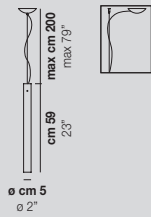

1x60W G9



USA & CANADA

1x60W G9

Sospensione in vetro soffiato incamiciato. Le dimensioni ridotte del corpo tubolare richiedono un'elevata maestria nella fase di soffiatura per garantire uno spessore omogeneo. Grazie alla sorgente luminosa alogena Candela crea un effetto luce di sicuro fascino.

A pendant made with blown cased glass. Its narrow diameter needs a good deal of skill to blow a piece with homogeneous thickness. Thanks to its halogen light source, Candela creates a fascinating light effect.

Finitura vetro / Glass finish

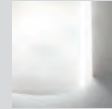

BC/LU

Finitura struttura / Frame finish



CR



WITHWHITE

design Mauro Olivieri 2009

Whitwhite SP 26 X / 18 X / 36 M / P / 46 G



Whitwhite SP 46 X / M / 18 G / 36 P / 26 M



WITHWHITE SP P

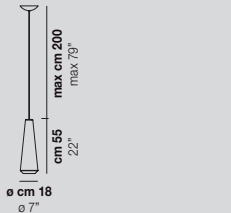

1x77W E27



USA & CANADA

1x60W E26

WITHWHITE SP M

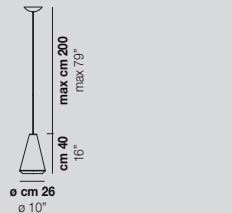

1x77W E27



USA & CANADA

1x60W E26

WITHWHITE SP G

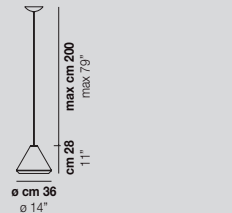

1x77W E27



USA & CANADA

1x60W E26

Collezione di cinque elementi singoli in vetro soffiato satinato, che possono essere installati sia come sospensioni che come lampade da soffitto, ideali per lampadine a risparmio energetico. Le versioni con doppio vetro prevedono un sistema a doppia accensione.

A collection of five single elements in satin-finish blown glass that can be installed as pendants or ceiling fixtures and are ideal for energy saving bulbs. The double glass versions allow a double switch system.

Finitura vetro / Glass finish



BC/ST

Finitura struttura / Frame finish



BC

WITHWHITE SP X

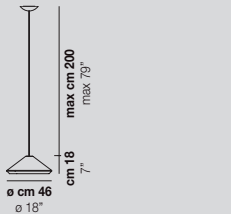

1x77W E27



USA & CANADA

1x60W E26

WITHWHITE SP 18 P

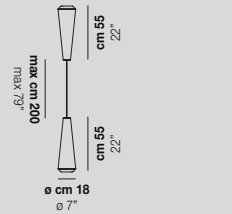

2x77W E27



USA & CANADA

2x60W E26

WITHWHITE SP 18 M

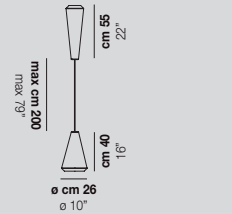

2x77W E27



USA & CANADA

2x60W E26

WITHWHITE SP 18 G

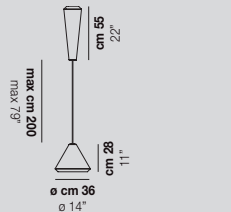

2x77W E27



USA & CANADA

2x60W E26

WITHWHITE SP 18 X

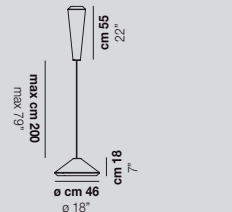

2x77W E27



USA & CANADA

2x60W E26

WITHWHITE SP 26 P

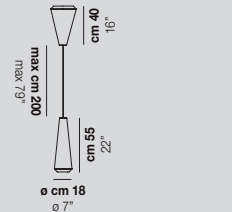

2x77W E27



USA & CANADA

2x60W E26

WITHWHITE SP 26 M

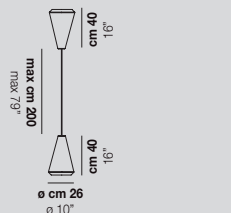

2x77W E27



USA & CANADA

2x60W E26

WITHWHITE SP 26 G

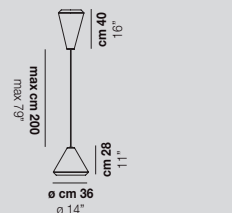

2x77W E27



USA & CANADA

2x60W E26

WITHWHITE SP 26 X

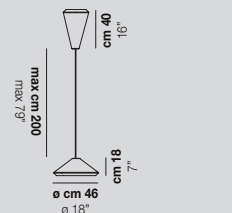

2x77W E27



USA & CANADA

2x60W E26



Whitwhite SP P / M / G

WITHWHITE SP 36 P

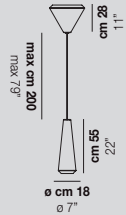

2x77W E27



USA & CANADA

2x60W E26

WITHWHITE SP 36 M

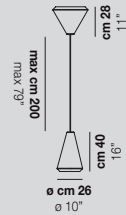

2x77W E27



USA & CANADA

2x60W E26

WITHWHITE SP 36 G

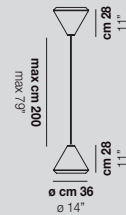

2x77W E27



USA & CANADA

2x60W E26

Collezione di cinque elementi singoli in vetro soffiato satinato, che possono essere installati sia come sospensioni che come lampade da soffitto, ideali per lampadine a risparmio energetico. Le versioni con doppio vetro prevedono un sistema a doppia accensione.

A collection of five single elements in satin-finish blown glass that can be installed as pendants or ceiling fixtures and are ideal for energy saving bulbs. The double glass versions allow a double switch system.

Finitura vetro / Glass finish



BC/ST

Finitura struttura / Frame finish



BC

WITHWHITE SP 36 X

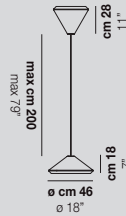

2x77W E27



USA & CANADA

2x60W E26

WITHWHITE SP 46 P

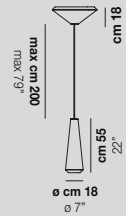

3x77W E27



USA & CANADA

2x60W E26

WITHWHITE SP 46 M

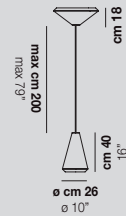

3x77W E27



USA & CANADA

2x60W E26

WITHWHITE SP 46 G

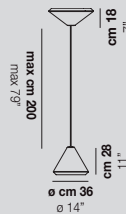

3x77W E27



USA & CANADA

2x60W E26

WITHWHITE SP 46 X

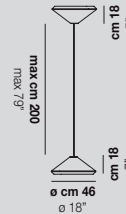

3x77W E27



USA & CANADA

2x60W E26





Essence SP 5

ESSENCE SP

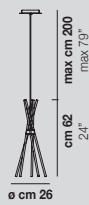

1x5W LED 20

CE EAC

USA & CANADA

1x5W LED 20

ESSENCE SP 5

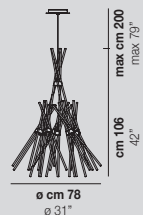

5x5W 3000 lm LED 20

CE EAC

USA & CANADA 

5x5W 3000 lm LED 20

Collezione di lampade con diffusore in canne di vetro lavorato a mano. La superficie è parzialmente opacizzata da una sabbiatura sfumata. Sorgente luminosa a LED.

Collection of lamps with diffuser in handmade glass rods. The surface is partially matted by a faded-sandblasting process. LED light source.

Finitura vetro / Glass finish



CR/SF

Finitura struttura / Frame finish

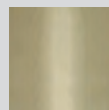

AB

LED Europe/International 
20 5W - 10V - 600 lm - 2700K/3000K - DIM2/DIM3

LED Usa & Canada
20 5W - 10V - 600 lm - 2700K/3000K - DIM2/DIM3



SP

DIADEMA

design Romani Sacconi Architetti Associati 2005



Diadema SP 60 B



Diadema SP C_2





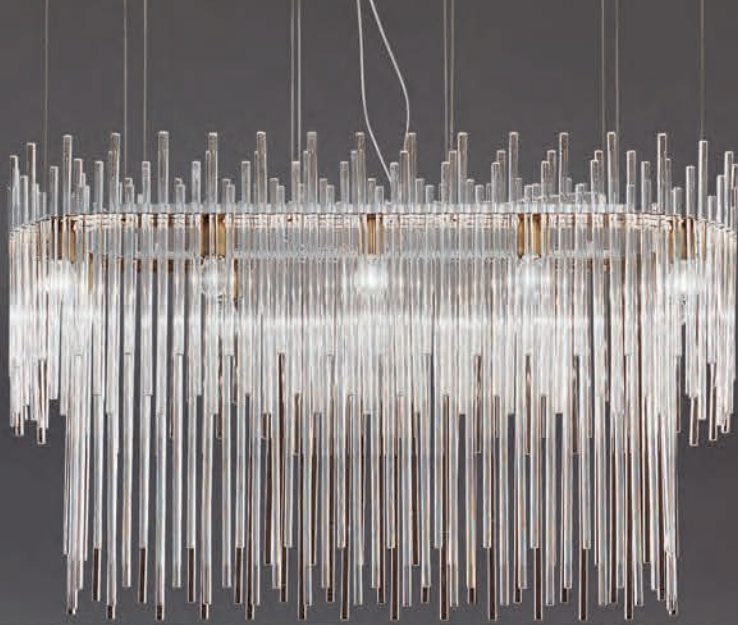

Diadema SP 02

DIADEMA SP 60 B

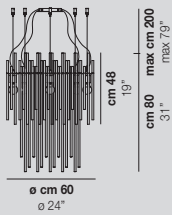

8x77W E27
 CE  **USA & CANADA** 
 8x60W E26

DIADEMA SP K3

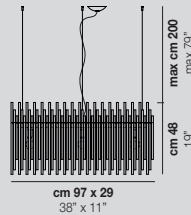

3x77W E27
 CE  **USA & CANADA** 
 3x60W E26

DIADEMA SP O2

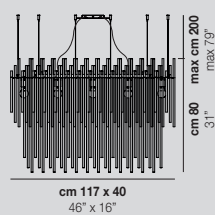

10x77W E27
 CE  **USA & CANADA** 
 10x60W E26

DIADEMA SP C_2

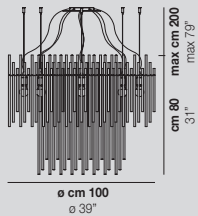

8x77W E27
 CE  **USA & CANADA** 
 8x60W E26



Luce in movimento. È la sensazione che invade l'ambiente quando si accende una Diadema. Il lavoro di Romani Saccani Architetti Associati, padri di questo progetto, si concentra dapprima sul singolo elemento della canna di vetro in cristallo per poi svilupparsi su un sistema composto: combinando canne di diverse dimensioni, la luce si riflette e trasmette la dinamicità desiderata. Numerose le varianti e le possibilità di personalizzazione. Tonalità del vetro in cristallo. Parti metalliche in finitura bronzo satinato e cromo.

Light in motion. That is the sensation pervading the environment when a Diadema is switched on. The work of Romani Saccani Architetti Associati, the fathers of this project, first concentrates on the single element of the glass rod and then develops on a composite system: by combining rods of different sizes, the light is reflected and conveys the desired dynamism. Several variants and possibilities for customization are available. Crystal glass shade. Metal parts finishing in satin bronze and chrome.

Finitura vetro / Glass finish



CR

Finitura struttura / Frame finish

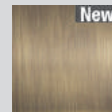

BS



CR

Collezione / Collection





Diadema SP K3

DIADEMA SP A P

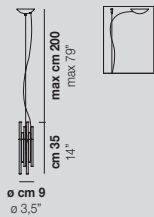

1x60W G9 / LED C



USA & CANADA

1x60W G9 / LED C

DIADEMA SP A M

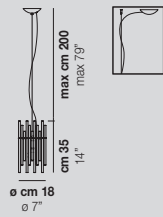

1x77W E27 / LED C



USA & CANADA

1x60W E26 / LED C

DIADEMA SP A G

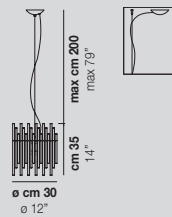

1x77W E27 / LED C



USA & CANADA

1x60W E26 / LED C

DIADEMA SP B P

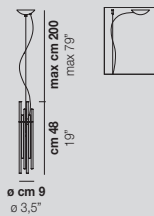

1x60W G9 / LED C



USA & CANADA

1x60W G9 / LED C

DIADEMA SP B M

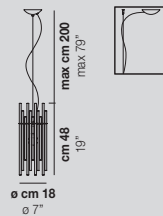

1x77W E27 / LED C



USA & CANADA

1x60W E26 / LED C

DIADEMA SP B G

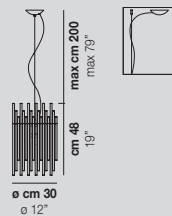

1x77W E27 / LED C



USA & CANADA

1x60W E26 / LED C

DIADEMA SP C P

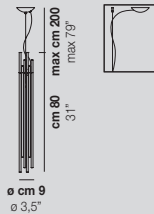

1x60W G9 / LED C



USA & CANADA

1x60W G9 / LED C

DIADEMA SP C M

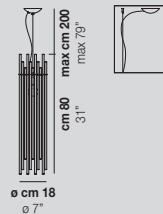

1x77W E27 / LED C



USA & CANADA

1x60W E27 / LED C

DIADEMA SP C G

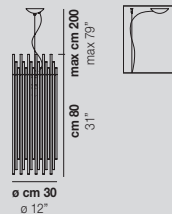

1x77W E27 / LED C



USA & CANADA

1x60W E27 / LED C

Luce in movimento. È la sensazione che invade l'ambiente quando si accende una Diadema. Il lavoro di Romani Saccani Architetti Associati, padri di questo progetto, si concentra dapprima sul singolo elemento della canna di vetro in cristallo per poi svilupparsi su un sistema composto: combinando canne di diverse dimensioni, la luce si riflette e trasmette la dinamicità desiderata. Numerose le varianti e le possibilità di personalizzazione. Tonalità del vetro in cristallo. Parti metalliche in finitura bronzo satinato e cromo.

Light in motion. That is the sensation pervading the environment when a Diadema is switched on. The work of Romani Saccani Architetti Associati, the fathers of this project, first concentrates on the single element of the glass rod and then develops on a composite system: by combining rods of different sizes, the light is reflected and conveys the desired dynamism. Several variants and possibilities for customization are available. Crystal glass shade. Metal parts finishing in satin bronze and chrome.

Finitura vetro / Glass finish



CR

Finitura struttura / Frame finish



BS

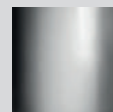

CR

LED Europe/International

C 12W - 35V - 1500lm/1600lm - 2700K/3000K - DIM2/DIM3

LED Usa & Canada



C 12W - 35V - 1500lm/1600lm - 2700K/3000K - DIM2/DIM3



Collezione / Collection



274

324

367

391

ECOS

design Renato Toso, Noti Massari & Associati 2007



Ecos SP 90



Ecos SP 60C



Ecos SP 60C





Ecos SP 35

ECOS SP 35

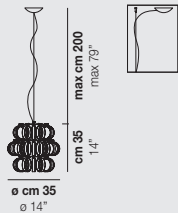

1x77W E27



USA & CANADA

1x60W E26

ECOS SP 60C

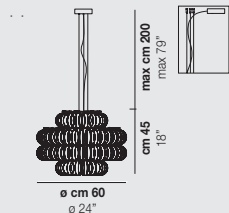

4x77W E27



USA & CANADA

4x60W E26

ECOS SP 90

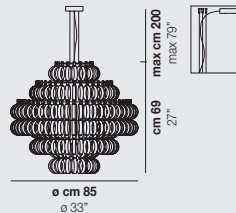

5x77W E27



USA & CANADA

5x60W E26

Un anello, infinite combinazioni. La matrice da cui nasce l'idea della collezione Ecos è una sola: l'anello di vetro. Le declinazioni cromatiche e di texture che i designer Renato Toso, Noti Massari e Associati hanno saputo ricavare da questo semplice elemento sono davvero molte. Questo rende la collezione estremamente personalizzabile in termini di forme e misure, per un'illuminazione davvero originale. Tonalità del vetro bianco o cristallo con lavorazione rigadin. Parti metalliche in finitura bronzo satinato e cromo.

One ring, infinite combinations. The concept of the Ecos collection is just in one element: the glass ring. The chromatic and texture variations that the designers Renato Toso, Noti Massari e Associati have been able to obtain from this simple element are several. That makes the collection extremely customizable in terms of shapes and sizes, for a truly original lighting. Rigadin white or crystal colour glass. Metal parts finishing in satin bronze and chrome.

Finitura vetro / Glass finish



BC/RI

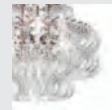

CR/RI

Finitura struttura / Frame finish



BS



CR



Collezione / Collection



276



328



390

GIOGALI
design Angelo Mangiarotti 1967



Giogali SP 3E



Giogali SP 80



GIOGALI SP 35

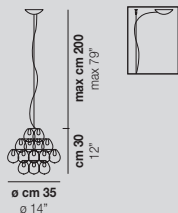

1x77W E27



USA & CANADA

1x60W E26

GIOGALI SP 3E

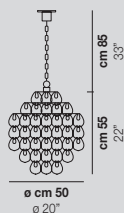

3x77W E27



USA & CANADA

3x60W E26

GIOGALI SP 50

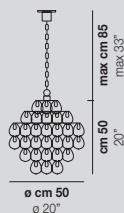

1x77W E27



USA & CANADA

1x60W E26

GIOGALI SP 60

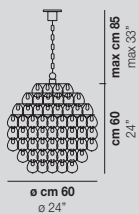

3x77W E27



USA & CANADA

3x60W E26

GIOGALI SP 80

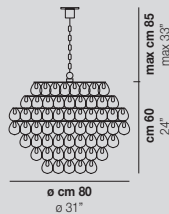

5x77W E27



USA & CANADA

5x60W E26

Un elemento, puro: il gancio di cristallo. È l'intuizione di un Maestro del design italiano come Angelo Mangiarotti che, nel 1967, dà origine al best seller del catalogo Vistosi, Giogali. Un intreccio iconico applicato alla versione che si preferisce.

A pure element: the crystal hook. It is the intuition of a master of Italian design, Angelo Mangiarotti, who in 1967 created the best seller of the Vistosi catalogue, Giogali. An iconic interweaving applied to the version one prefers.

Finitura vetro / Glass finish



BC



CR/AG



CR/AM



CR/BR



CR/FU



CR/NN



CR/OR



CR/RA



CR/TR



NE

Finitura struttura / Frame finish

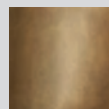

BR

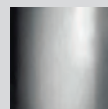

CR



Collezione / Collection



278



332

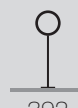

392





Giogali SP R1B



GIOGALI SP RE2

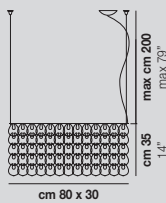

3x77W E27
 CE CB EAC PS
 USA & CANADA
 3x60W E26

GIOGALI SP RE1

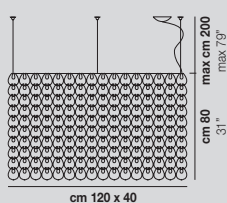

10x77W E27
 CE CB EAC PS
 USA & CANADA
 10x60W E26

GIOGALI SP R1B

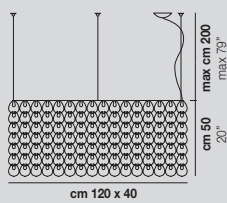

10x77W E27
 CE EAC PS
 USA & CANADA
 10x60W E26

GIOGALI SP CUB

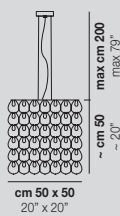

3x77W E27
 CE CB EAC PS
 USA & CANADA
 3x60W E26

GIOGALI SP OV1

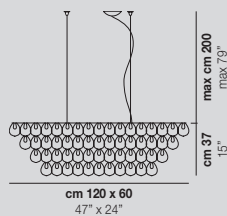

4x77W E27
 CE CB EAC PS
 USA & CANADA
 4x60W E26

GIOGALI SP JEL

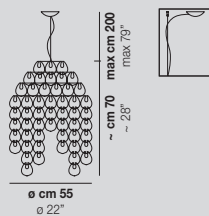

1x77W E27
 CE CB EAC PS
 USA & CANADA
 1x60W E26

Un elemento, puro: il gancio di cristallo. È l'intuizione di un Maestro del design italiano come Angelo Mangiarotti che, nel 1967, dà origine al best seller del catalogo Vistosi, Giogali. Un intreccio iconico applicato alla versione che si preferisce.

A pure element: the crystal hook. It is the intuition of a master of Italian design, Angelo Mangiarotti, who in 1967 created the best seller of the Vistosi catalogue, Giogali. An iconic interweaving applied to the version one prefers.

Finitura vetro / Glass finish



BC



CR/AG

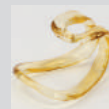

CR/AM



CR/BR



CR/FU



CR/NN



CR/OR

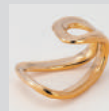

CR/RA



CR/TR



NE

Finitura struttura / Frame finish

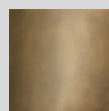

BR



CR

Collezione / Collection



278



332



392

MINIGIOGALI

design Angelo Mangiarotti 1967 - restyling 2009







Minigiogali SP 25

MINIGIOGALI SP 25

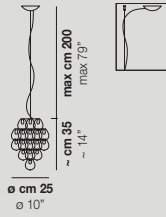

1x60W G9
CE ENEC
 USA & CANADA
 1x60W G9

MINIGIOGALI SP 35

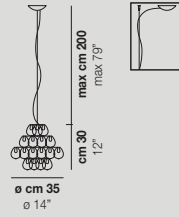

1x77W E27
CE ENEC CB ENEC
 USA & CANADA
 1x60W E26

MINIGIOGALI SP 50

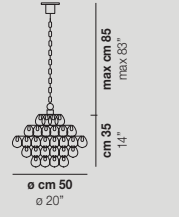

1x77W E27
CE ENEC CB ENEC
 USA & CANADA
 1x60W E26

MINIGIOGALI SP 3E

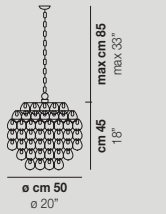

3x77W E27
CE ENEC CB ENEC
 USA & CANADA
 3x60W E26

MINIGIOGALI SP 60

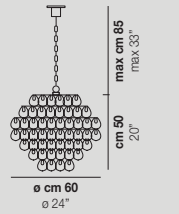

3x77W E27
CE ENEC CB ENEC
 USA & CANADA
 3x60W E26

MINIGIOGALI SP 80

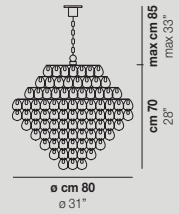

5x77W E27
CE ENEC CB ENEC
 USA & CANADA
 5x60W E26

La versione ridotta di Giogali, che permette di impiegare i ganci in cristallo per installazioni a parete di minori dimensioni, standard o su misura.

The small size version of Giogali, which allows the use of glass hooks for smaller, standard or custom-made wall installations.

Finitura vetro / Glass finish



BC



CR/AG



CR/AM



CR/BR



CR/FU



CR/NN



CR/OR



CR/RA



CR/TR



NE

Finitura struttura / Frame finish

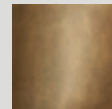

BR



CR

Collezione / Collection



282



330

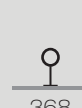

368

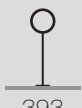

393



MINIGIOGALI SP RE2

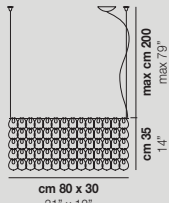

3x77W E27
 CE CB ENEC PS
 USA & CANADA
 3x60W E26

MINIGIOGALI SP CHA

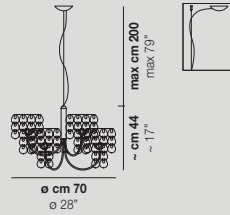

6x60W G9
 CE ENEC PS
 USA & CANADA
 6x60W G9

MINIGIOGALI SP CLO

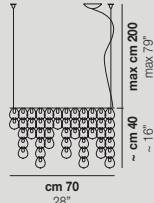

3x60W G9
 CE ENEC
 USA & CANADA
 3x60W G9

MINIGIOGALI SP CLA



3x77W E27
 CE CB ENEC PS
 USA & CANADA
 3x60W E26

MINIGIOGALI SP OV1

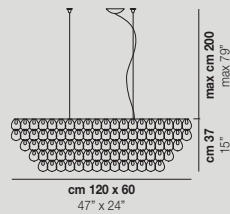

4x77W E27
 CE CB ENEC
 USA & CANADA
 4x60W E26

La versione ridotta di Giogali, che permette di impiegare i ganci in cristallo per installazioni a parete di minori dimensioni, standard o su misura.

The small size version of Giogali, which allows the use of glass hooks for smaller, standard or custom-made wall installations.

Finitura vetro / Glass finish



BC



CR/AG



CR/AM



CR/BR



CR/FU



CR/NN



CR/OR



CR/RA



CR/TR



NE

Finitura struttura / Frame finish

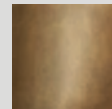

BR



CR

Collezione / Collection



282



330

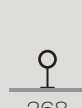

368

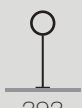

393

Plafoniere / Ceiling

Sospensioni / <i>Suspensions</i>	29
Parete / <i>Wall</i>	287
Tavolo / <i>Table</i>	335
Terra / <i>Floor</i>	371



Plafoniere / Ceiling



Aurora
258

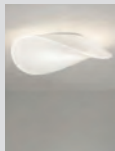

Balance
232

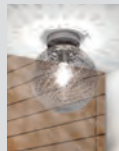

Bolle
244



Bot
246



Damasco
268



Diadema
274



Diamante
270

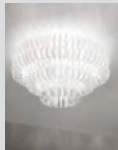

Ecos
276



Futura
252



Giogali
278

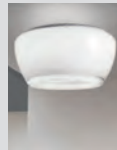

Implode
248

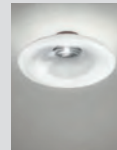

Incanto
228

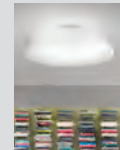

Infinita
234

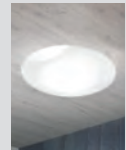

Lio
256

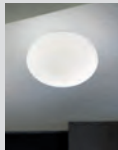

Lucciola
266

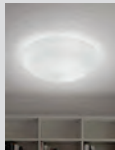

Mia
260



Minigiogali
282

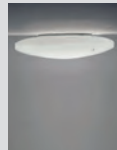

Moris
238

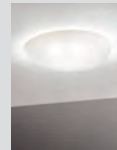

Neochic
236

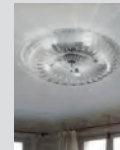

Novecento
240

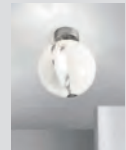

Poc
269



Pod
230

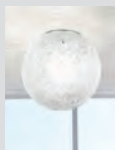

Rina
242

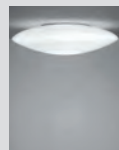

Saba
264



Semai
250



Sogno
262



Spirit
254



Tubes
272

INCANTO
design Pio & Tito Toso 2019



Incanto PL

INCANTO PL

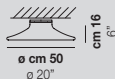

1x15W LED 03

CE EAC

USA & CANADA 

1x15W LED 03

La sorgente LED accende il vetro sfumato bianco. I toni neutri e le linee semplici ed eleganti permettono di contestualizzarla in ambienti dagli stili più diversi. Montatura nickel nero satinato o bianca.

The LED source lights up the white shaded glass. Neutral tones and simple, elegant lines allow it to be contextualised in environments with the most diverse styles. Black matt nickel or white metal finishes.

Finitura vetro / Glass finish



BC/SF

Finitura struttura / Frame finish



BO

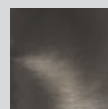

NNS



BC/SF_BO

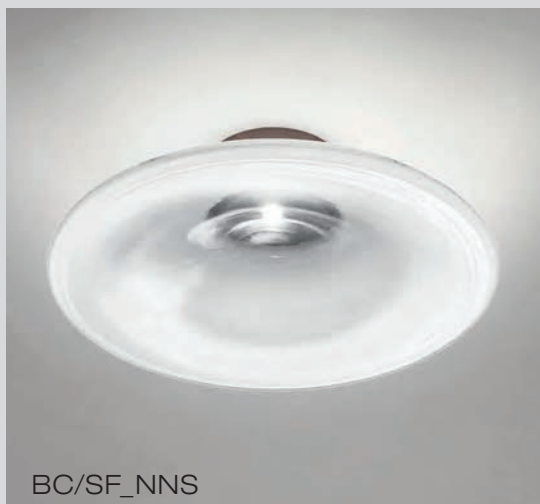

BC/SF_NNS

LED Europe/International 

03 15W - 230V - 1300lm - 3000K - DIM2

LED Usa & Canada 

03 15W - 110V - 1200lm - 3000K - DIM2

Collezione / Collection



92

POD

design Babled & Co. 2005



POD PP P

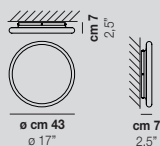

1x12W LED 18

CE EAC

USA & CANADA

1x12W LED 18

POD PP G

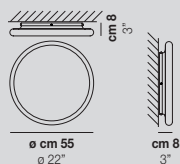

1x18W LED 19

CE EAC

USA & CANADA

1x18W LED 19

La collezione Pod è resa preziosa da giochi di traslucidità e trasparenza che vengono esaltati dalla nuova sorgente Led. La macchia bianca nella parte centrale del diffusore è una lavorazione completamente artigianale che fa sì che assuma ogni volta geometrie diverse così da rendere ogni lampada un pezzo unico e irripetibile.

The Pod collection is characterized by translucent and transparent finishes that are enhanced by the new LED source. The white spot in the central part of the diffuser is a completely handcrafted process. This is the reason why it is different in every item, making each lamp a unique and unrepeatabe piece.

Finitura vetro / Glass finish



BC/LU

Finitura struttura / Frame finish



BC

LED Europe/International CE EAC

18 12W - 24V - 1900lm - 2700K/3000K - DIM2/DIM3

19 18W - 36,5V - 2800lm - 2700K/3000K - DIM2/DIM3

LED Usa & Canada

18 12W - 24V - 1900lm - 2700K - 3000K - DIM2/DIM3

19 18W - 36,5V - 2800lm - 2700K - 3000K - DIM2/DIM3



PP P / G

BALANCE

design Pio e Tito Toso 2011



Balance PP G

BALANCE PP 24

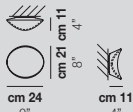

1x46W E14



USA & CANADA

1x40W E12

BALANCE PP M

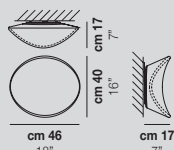

2x77W E27 / LED G



USA & CANADA

2x60W E26 / LED G

BALANCE PP G

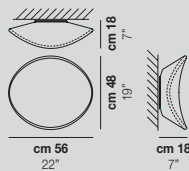

2x77W E27 / LED G



USA & CANADA

2x60W E26 / LED G

La traiettoria delle orbite planetarie intorno al sole ispira questa collezione, che ripropone il movimento creato dall'armonia e dall'equilibrio di forze invisibili con vetro e luce. Disponibile in tre dimensioni.

The elliptical orbit of a planet around the sun inspires this collection, which reminds of the movement created by the harmony and balance of invisible forces with glass and light. Available in three sizes.

Finitura vetro / Glass finish

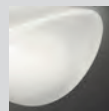

BC/LU

Finitura struttura / Frame finish



BC



BO*

LED version: BO*

LED Europe/International



G 19W - 39V - 2850 lm - 2700K/3000K - DIM2/DIM3

LED Usa & Canada



G 19W - 39V - 2850 lm - 2700K/3000K - DIM2/DIM3



PP 24 / M / G

Collezione / Collection



144



306

INFINITA

design Renato Toso, Noti Massari & Associati 2009



Infinita PL 80

INFINITA PP 36

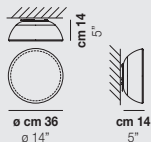

1x77W E27 / **LED F**
CE **CB ENEC**
USA & CANADA
 1x60W E26 / **LED F**

INFINITA PP 53

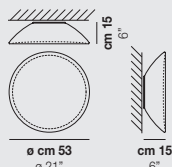

2x77W E27 / **LED G**
CE **CB ENEC**
USA & CANADA
 2x60W E26 / **LED G**

INFINITA PL 80

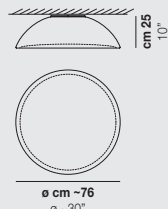

5x77W E27 / **LED O**
CE **CB ENEC**
USA & CANADA
 5x60W E26 / **LED O**

In versione sospensione, soffitto o parete, è la risposta perfetta per chi cerca una lampada dalle grandi dimensioni. Il diffusore soprattutto nella dimensione più grande offre un'ampia superficie nonostante una montatura metallica essenziale.

Available as pendant, ceiling or wall lamp. It is the perfect answer for those looking for a large lamp. The diffuser, especially in the bigger size, offers a large lighting surface area despite a minimalist metal frame.

Finitura vetro / Glass finish



BC/ST

Finitura struttura / Frame finish



BC

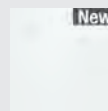

BO*

LED version: BO*

LED Europe/International **CE ENEC**

- F** 12W - 24V - 1700 lm - 2700K/3000K - DIM2/DIM3
- G** 19W - 39V - 2850 lm - 2700K/3000K - DIM2/DIM3
- O** 26W - 39V - 3700 lm - 2700K/3000K - DIM2/DIM3

LED Usa & Canada

- F** 12W - 24V - 1700 lm - 2700K/3000K - DIM2/DIM3
- G** 19W - 39V - 2850 lm - 2700K/3000K - DIM2/DIM3
- O** 26W - 39V - 3700 lm - 2700K/3000K - DIM2/DIM3



Collezione / Collection



146

NEOCHIC

design Chiaramonte & Marin 2013



Neochic PP G

NEOCHIC PP P

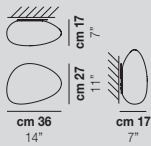

1x77W E27 / LED F
 CE CB ENEC
 USA & CANADA
 1x60W E26 / LED F

NEOCHIC PP M

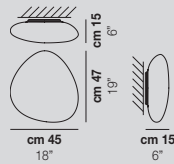

2x77W E27 / LED G
 CE CB ENEC
 USA & CANADA
 2x60W E26 / LED G

NEOCHIC PP G

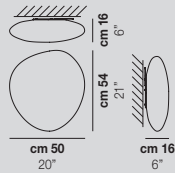

2x77W E27 / LED G
 CE CB ENEC
 USA & CANADA
 2x60W E26 / LED G

Le curve morbide e la superficie levigata incontrano il vetro soffiato in un modello di estrema semplicità, adatto a qualsiasi contesto d'arredo.

Soft curves and a polished surface meet blown glass in a model of extreme simplicity, suitable for any context.

Finitura vetro / Glass finish

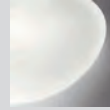

BC/ST

Finitura struttura / Frame finish



BC



BO*

LED version: BO*

NEOCHIC PP R

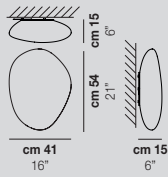

2x77W E27 / LED G
 CE CB ENEC
 USA & CANADA
 2x60W E26 / LED G

LED Europe/International

F 12W - 24V - 1700 lm - 2700K/3000K - DIM2/DIM3

G 19W - 39V - 2850 lm - 2700K/3000K - DIM2/DIM3

LED Usa & Canada

F 12W - 24V - 1700 lm - 2700K/3000K - DIM2/DIM3

G 19W - 39V - 2850 lm - 2700K/3000K - DIM2/DIM3



Collezione / Collection



136



294

PPP / M / G / R

MORIS

studio tecnico Vetreria Vistosi 1998



Moris PP 50

MORIS PP 30

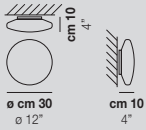

1x77W E27 / **LED F**
CE **CB ENEC**
USA & CANADA
 1x60W E26 / **LED F**

MORIS PP 40

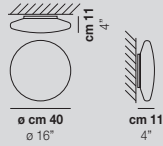

1x77W E27 / **LED G**
CE **CB ENEC**
USA & CANADA
 1x60W E26 / **LED G**

MORIS PP 50

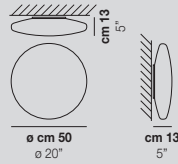

2x77W E27 / **LED G**
CE **CB ENEC**
USA & CANADA
 2x60W E26 / **LED G**

Disponibile in tre diverse dimensioni, Moris si presta ad essere installata come lampada da soffitto o da parete. La forma a lente del diffusore in vetro satinato ottimizza il flusso luminoso.

Moris is available in three different sizes. It can be placed both as a ceiling and a wall lamp. The lens shape of the matt finished glass diffuser optimises the light flow.

Finitura vetro / Glass finish

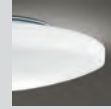

BC/ST

Finitura struttura / Frame finish



BC

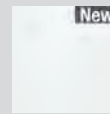

BO*

LED version: BO*

LED Europe/International

CE ENEC

F 12W - 24V - 1700 lm - 2700K/3000K - DIM2/DIM3

G 19W - 39V - 2850 lm - 2700K/3000K - DIM2/DIM3

LED Usa & Canada

F 12W - 24V - 1700 lm - 2700K/3000K - DIM2/DIM3

G 19W - 39V - 2850 lm - 2700K/3000K - DIM2/DIM3

NOVECENTO

design Romani Saccani Architetti Associati 2013



Novecento PL

NOVECENTO PL

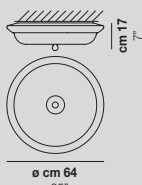

5x60W E14



USA & CANADA

5x40W E12

La forma di questa collezione nasce dalla volontà di reinterpretare il tradizionale lampadario muranese. Finitura del vetro cristallo o bianco rigadin è stata il tocco da maestro: le sue rigature radiali evocano l'andamento dei bracci dello storico candeliere mantenendo un sapore contemporaneo.

The shape of this collection stems from the desire to reinterpret the traditional Murano chandelier. The choice of the crystal or white rigadin glass finish was the master's touch: its radial stripes evoke the arms of the historic candlestick while maintaining a contemporary flavour.

Finitura vetro / Glass finish



BC/RI



CR/RI

Finitura struttura / Frame finish



CR



Collezione / Collection



94



366



386

RINA

design Barbara Maggiolo 2009



Rina PL 45

RINA PL 25



1x77W E27



USA & CANADA

1x60W E26

RINA PL 35

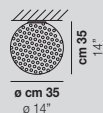

1x77W E27



USA & CANADA

1x60W E26

RINA PL 45

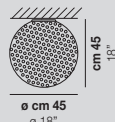

3x77W E27



USA & CANADA

3x60W E26

Si ispira al tarassaco, del quale ricorda il pappo, grazie alla leggera texture della superficie, realizzata con la tradizionale tecnica delle murrine. Rina è disponibile in diverse misure che si possono combinare in un'ampia gamma di installazioni.

Rina is inspired by the dandelion, of which it recalls the pappus, thanks to the light texture of the surface, made with the traditional technique of murrine. It is available in different sizes that can be combined in a wide range of installations.

Finitura vetro / Glass finish



BC/MU

Finitura struttura / Frame finish

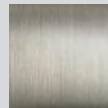

NI

RINA FA 16

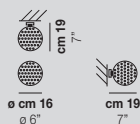

1x60W G9 / LED D



USA & CANADA

1x60W G9 / LED D



LED Europe/International



D 9W - 34V - 1100lm/1200lm - 2700K/3000K - DIM2/DIM3

LED Usa & Canada



D 9W - 34V - 1100lm/1200lm - 2700K/3000K - DIM2/DIM3

Collezione / Collection



98



346

BOLLE

design Barbara Maggiolo 2003



Bolle PL G

BOLLE PL G



1x77W E27



USA & CANADA

1x60W E26

BOLLE FA P

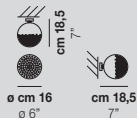

1x60W G9 / LED D



USA & CANADA

1x60W G9 / LED D

La caratteristica texture di questa collezione viene dalla tecnica "balloton", che consiste nell'inserimento di bolle d'aria nel vetro durante la lavorazione. L'effetto "tessuto" che si ottiene moltiplica i riflessi sulla superficie della sfera.

The main characteristic of this collection of lamps produced with the "balloton" technique is the insertion of bubbles of air in the glass during its production. That creates multiple reflections and adds an organic texture on the surface of the sphere.

Finitura vetro / Glass finish



BC/BO



CR/BO

Finitura struttura / Frame finish

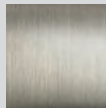

NI

LED Europe/International



D 9W - 34V - 1100lm/1200lm - 2700K/3000K - DIM2/DIM3

LED Usa & Canada



D 9W - 34V - 1100lm/1200lm - 2700K/3000K - DIM2/DIM3



Collezione / Collection



118



364

BOT

design Gregorio Spini 2011



Bot PP 45

BOT PP 45

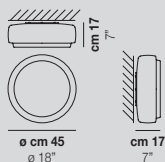

2x77W E27 / LED G
CE CB ENEC
USA & CANADA
2x60W E26 / LED G

Un volume in movimento che ne genera uno nuovo è il concetto rappresentato dalla collezione Bot che allo stesso tempo richiama il processo della soffiatura del vetro, in cui il materiale incandescente contiene la luce, prima ancora di avere una forma definitiva.

A collection that represents the idea of a volume in motion generating a new one. The concept is also a reminiscence of the process of glass blowing in which the incandescent glass contains light even before it has a definite form.

Finitura vetro / Glass finish



BC/CR

Finitura struttura / Frame finish



BC

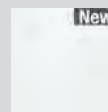

BO*

LED version: BO*

LED Europe/International CE ENEC
G 19W - 39V - 2850lm - 2700K/3000K - DIM2/DIM3

LED Usa & Canada
G 19W - 39V - 2850lm - 2700K/3000K - DIM2/DIM3



Collezione / Collection



132

IMPLODE

design Gregorio Spini 2011



Implode PL 50

IMPLODE PL 50

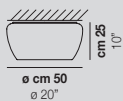

3x77W E27 / LED 0



USA & CANADA

3x60W E26 / LED 0

Questa linea rappresenta l'illusione di una superficie creata dall'implosione di un volume. Il vetro, grazie alla sua densità, lascia trasparire le gradazioni di strati multipli di cristallo bianco e trasparente.

A collection that represents the illusion of a surface created by the implosion of a volume. The glass, due to its thickness, shows a gradation of multiple layers of white and transparent crystal.

Finitura vetro / Glass finish



BC/CR

Finitura struttura / Frame finish



BC



BO*

LED version: BO*

LED Europe/International



0 26W - 39V - 3700lm - 2700K/3000K - DIM2/DIM3

LED Usa & Canada



0 26W - 39V - 3700lm - 2700K/3000K - DIM2/DIM3



Collezione / Collection



130

SEMAI

design Alberto Saggia e Valerio Sommella 2015



Semai PL M

SEMAI PL P



o cm 30
o 12"

1x46W E14



USA & CANADA .UL.us

1x40W E12

SEMAI PL M

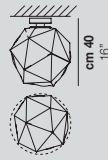

o cm 40
o 16"

1x77W E27



USA & CANADA .UL.us

1x60W E26

Collezione di lampade in vetro soffiato a bocca all'interno di una gabbia di acciaio. La tecnica di soffiaggio libera rende ciascuna lampada sempre diversa. Vetro bianco lucido. Gabbia inox scuro.

Collection of lamps made of a mouth-blown glass into a steel cage. This free blowing technique makes each lamp always different. Glossy white glass. Dark inox cage.

Finitura vetro / Glass finish



BC/LU

Finitura struttura / Frame finish



BC



Collezione / Collection



134

FUTURA

design Hangar Design Group 2015



Futura PL G

FUTURA PL P

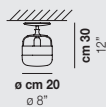

1x77W E27



USA & CANADA

1x60W E26

FUTURA PL G

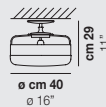

1x77W E27



USA & CANADA

1x60W E26

Collezione di lampade costituite da un pezzo unico di vetro soffiato la cui particolare lavorazione però permette un doppio effetto cromatico: trasparente nella parte superiore, effetto satinato nella parte inferiore. Sono disponibili le seguenti possibilità di abbinamento vetro con anello metallico: vetro bianco con anello nero opaco, vetro fumé con anello marrone, vetro ambra con anello ottone. Nuova finitura vetro cristallo trasparente con possibilità di abbinare anello rame o nero opaco.

A collection of lamps made from a single piece of blown glass, whose particular workmanship, though, allows a double chromatic effect: transparent at the top, satin effect at the bottom. The following combinations of glass with metal ring are now available: white glass combined with matt black ring, smoky glass with brown ring, amber glass with painted brass ring. A new transparent crystal glass finish with copper or matt black ring is also available.

Finitura vetro / Glass finish



AM/OT



BC/NE



CR/NE



CR/RA

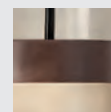

FU/MA

Finitura struttura / Frame finish

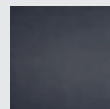

NE

Collezione / Collection

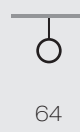

64

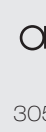

305



353



383



SPIRIT

design Marco Acerbis 2013



Spirit PP 45

SPIRIT PL 37

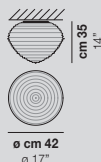

1x77W E27 / **LED F**
 CE CB ENEC PS
 USA & CANADA
 1x60W E26 / **LED F**

SPIRIT PP 45

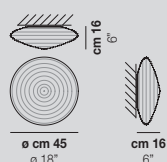

2x77W E27 / **LED G**
 CE CB ENEC PS
 USA & CANADA
 2x60W E26 / **LED G**

Spirit ha la forma del diamante soffiata nel vetro. Le particolari rigature, frutto di una lunga ricerca, catturano la luce e la riflettono, nascondendo la sorgente luminosa anche nella versione in cristallo trasparente.

Spirit has the shape of a diamond blown into glass. Its folds are the result of a long process of development that creates a unique light reflection, while keeping the source of light hidden even in the transparent crystal version.

Finitura vetro / Glass finish



BC/LU

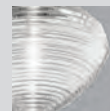

CR/TR

Finitura struttura / Frame finish



BC

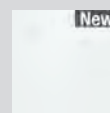

BO*

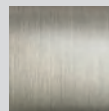

NI

LED version: BO*

LED Europe/International



F 12W - 24V - 1700lm - 2700K/3000K - DIM2/DIM3

G 19W - 39V - 2850lm - 2700K/3000K - DIM2/DIM3

LED Usa & Canada



F 12W - 24V - 1700lm - 2700K/3000K - DIM2/DIM3

G 19W - 39V - 2850lm - 2700K/3000K - DIM2/DIM3

LED **F** e **G** disponibili solo con finitura vetro BC/LU

LED **F** and **G** only available with BC/LU glass finish



PP 45

Collezione / Collection



86



369

LIO

archivio storico Vetreria Vistosi 1972



Lio PP 50

AURORA

studio tecnico Vetreria Vistosi 1986



Aurora PP 50

AURORA PP 30

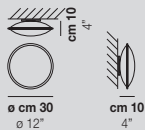

1x77W E27 / **LED F**
CE **CB ENEC**
USA & CANADA
 1x60W E26 / **LED F**

AURORA PP 40

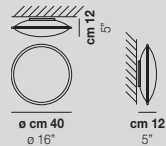

1x77W E27 / **LED F**
CE **CB ENEC**
USA & CANADA
 1x60W E26 / **LED F**

AURORA PP 50

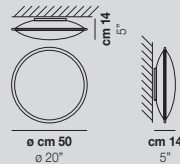

2x77W E27 / **LED G**
CE **CB ENEC**
USA & CANADA
 2x60W E26 / **LED G**

Un modello dalla forma lenticolare, nella versione plafoniera o lampada da parete. In tre diverse dimensioni, è realizzato in vetro bianco satinato, con il catteristico decoro "a morrisa".

A model with a lenticular shape, available in the ceiling or wall lamp versions. In three different sizes, it is made of satin-white glass, with the characteristic morrisa decoration.

Finitura vetro / Glass finish



BC/CR

Finitura struttura / Frame finish



BC



BO

LED version: BO*

LED Europe/International **CE ENEC**

F 12W - 24V - 1700 lm - 2700K/3000K - DIM2/DIM3

G 19W - 39V - 2850 lm - 2700K/3000K - DIM2/DIM3

LED Usa & Canada

F 12W - 24V - 1700 lm - 2700K/3000K - DIM2/DIM3

G 19W - 39V - 2850 lm - 2700K/3000K - DIM2/DIM3



MIA

studio tecnico Vetreria Vistosi 2013

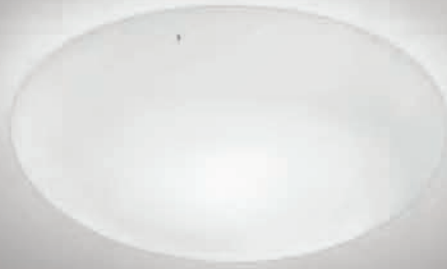

Mia PP 60

MIA PP 60

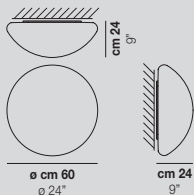

3x77W E27 / LED 0



USA & CANADA 

3x60W E26 / LED 0

La plafoniera è caratterizzata da una linea semplice, dolcemente bombata nella parte superiore. Garantisce un'aderenza ottimale al supporto, grazie alla montatura che riduce al minimo la distanza dal soffitto.

The ceiling lamp is characterized by a simple line, gently rounded at the top. It provides an excellent adhesion to the support, thanks to the frame that minimizes the distance from the ceiling.

Finitura vetro / Glass finish

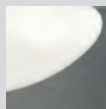

BC/ST

Finitura struttura / Frame finish



BC

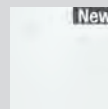

BO*

LED version: BO*

LED Europe/International



0 26W - 39V - 3700lm - 2700K/3000K - DIM2/DIM3

LED Usa & Canada



0 26W - 39V - 3700lm - 2700K/3000K - DIM2/DIM3



SOGNO

studio tecnico Vetreria Vistosi 2003

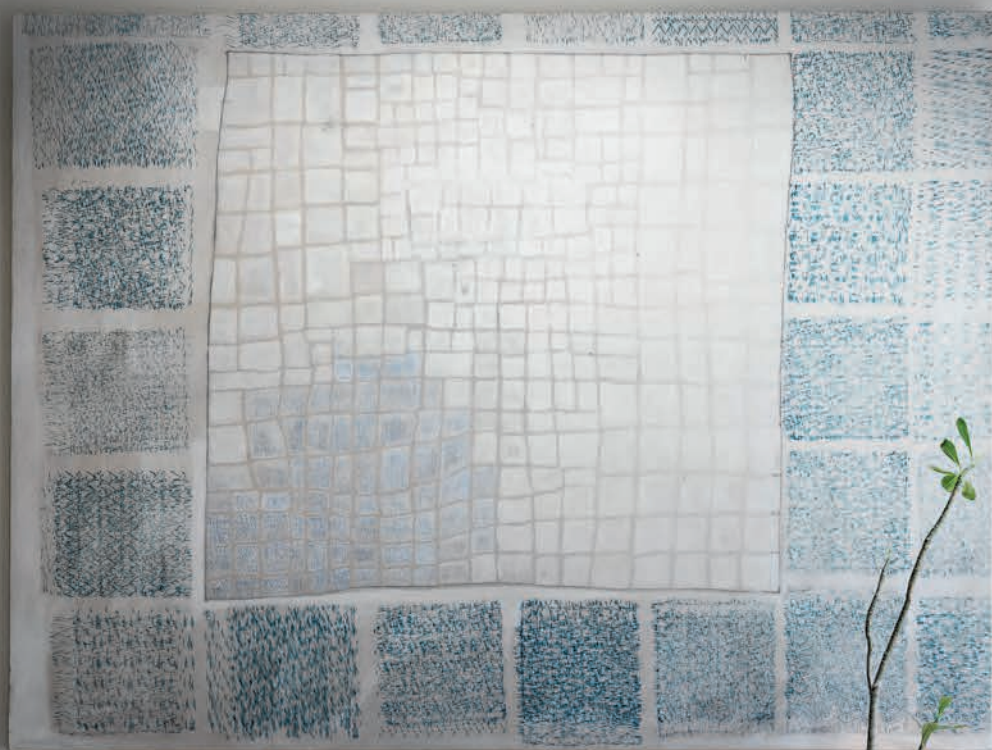

Sogno PP 55

SOGNO PP 42

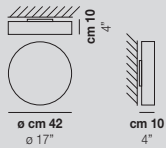

2x77W E27 / **LED G**
CE **CB** **ERAC**
USA & CANADA
 2x60W E26 / **LED G**

SOGNO PP 55

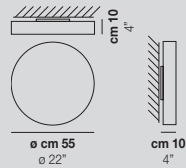

2x77W E27 / **LED G**
CE **CB** **ERAC**
USA & CANADA
 2x60W E26 / **LED G**

Disponibile in due misure, Sogno si può montare come lampada da soffitto o da parete. La finitura satinata crea una luce d'ambiente dolce e diffusa.

Available in two sizes, Sogno can be fitted both as a ceiling and as a wall lamp. The satin-finish blown glass helps to create a soft ambient light.

Finitura vetro / Glass finish

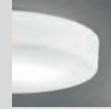

BC/ST

Finitura struttura / Frame finish



BC



BO*

LED version: BO*

LED Europe/International

CE **ERAC**

G 19W - 39V - 2850 lm - 2700K/3000K - DIM2/DIM3

LED Usa & Canada

G 19W - 39V - 2850 lm - 2700K/3000K - DIM2/DIM3

SABA

studio tecnico Vetreria Vistosi 1998



Saba PP 30 / 40 / 50 / 60

SABA PP 30

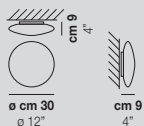

1x77W E27 / **LED F**
 CE
 USA & CANADA
 1x60W E26 **LED G**

SABA PP 40

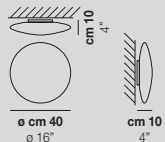

1x77W E27 / **LED G**
 CE
 USA & CANADA
 1x60W E26 / **LED G**

SABA PP 50

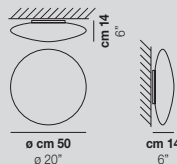

2x77W E27 / **LED G**
 CE
 USA & CANADA
 2x60W E26 / **LED G**

SABA PP 60

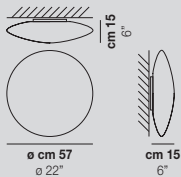

3x77W E27 / **LED O**
 CE
 USA & CANADA
 3x60W E26 / **LED O**

Disponibile in quattro dimensioni, Saba è lampada da soffitto o parete. La forma a lente del diffusore in vetro soffiato satinato bianco la rendono perfetta per l'illuminazione.

Available in four sizes, Saba is a pendant or ceiling lamp. The lenticular shape of the satin-finish blown glass makes it suitable for ambient lighting.

Finitura vetro / Glass finish



BC/ST

Finitura struttura / Frame finish



BC

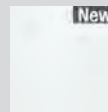

BO*

LED version: BO*

LED Europe/International

F 12W - 24V - 1700lm - 2700K/3000K - DIM2/DIM3

G 19W - 39V - 2850lm - 2700K/3000K - DIM2/DIM3

O 26W - 39V - 3700lm - 2700K/3000K - DIM2/DIM3

LED Usa & Canada

F 12W - 24V - 1700lm - 2700K/3000K - DIM2/DIM3

G 19W - 39V - 2850lm - 2700K/3000K - DIM2/DIM3

O 26W - 39V - 3700lm - 2700K/3000K - DIM2/DIM3



PP 50 E27

LUCCIOLA

archivio storico Vetreria Vistosi 1981



Lucciola FA 18 / PP 27 / PP P / PP M / PL G

LUCCIOLA FA 18

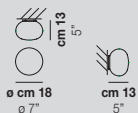

1x48W E14



USA & CANADA

1x40W E12

LUCCIOLA PP 27

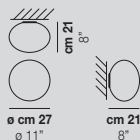

1x48W E14



USA & CANADA

1x40W E12

LUCCIOLA PP P

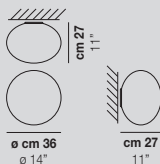

1x77W E27 / LED F



USA & CANADA

1x60W E26 / LED F

LUCCIOLA PP M

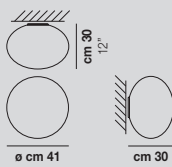

3x77W E27 / LED F



USA & CANADA

3x60W E26 / LED F

LUCCIOLA PL G

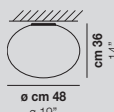

3x77W E27 / LED F



USA & CANADA

3x60W E26 / LED F

Una delle più versatili collezioni. La sua forma ovale in vetro soffiato satinato è disponibile in diverse dimensioni, che si prestano a innumerevoli combinazioni d'installazione.

One of our most versatile collections. The oval and mouth-blown satin glass shape is available in different sizes, which can be combined to offer countless installation combinations.

Finitura vetro / Glass finish



BC/ST

Finitura struttura / Frame finish



BC

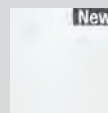

BO*

LED version: BO*

LED Europe/International



F 12W - 24V - 1700lm - 2700K/3000K - DIM2/DIM3

LED Usa & Canada



F 12W - 24V - 1700lm - 2700K/3000K - DIM2/DIM3

Collezione / Collection



140



308



354



384



DAMASCO

design Paolo Crepax 2003

Collezione realizzata con la tecnica a bozzolo, in cui l'originale decoro diventa un vero e proprio materiale: la sovrapposizione di fili di vetro fuso a creare una texture in rilievo. Damasco è una delle creazioni di più lungo successo, che vede nel tempo versioni sempre nuove.

The collection is produced with the bozzolo technique: that consists in applying threads of molten glass to create an organic texture. Damasco is one of our most successful series, which has been developed and extended during the years with new versions.

Finitura vetro / Glass finish

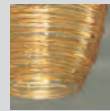

CR/AM



CR/CR

Finitura struttura / Frame finish

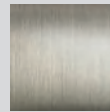

NI

LED Europe/International



D 9W - 34V - 1100lm/1200lm - 2700K/3000K - DIM2/DIM3

LED Usa & Canada



D 9W - 34V - 1100lm/1200lm - 2700K/3000K - DIM2/DIM3

Damasco FA C

DAMASCO FA C

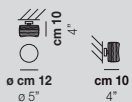

1x60W G9 / LED D



USA & CANADA

1x60W G9 / LED D



Collezione / Collection

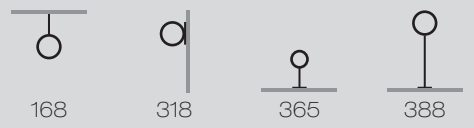



POC FA 16

POC FA 16

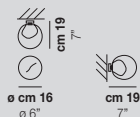

1x60W G9 / LED D
 CE CB ENEC
 USA & CANADA
 1x60W G9 / LED D



POC

design Barbara Maggiolo 2003

L'esclusivo impiego della membrana interna nella collezione Poc genera, come una lente, l'effetto di una sfera composta da due metà. La resa di ogni membrana è diversa, creando per ciascun pezzo dinamiche variazioni di intensità di luce e colore sulla superficie.

The unique use of the inner membrane in the Poc collection generates, like a lens, the effect of a sphere composed of two halves. The rendering of each membrane is different, creating for each piece dynamic variations of light intensity and colour on the surface.

Finitura vetro / Glass finish

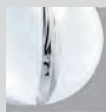

CR/BC

Finitura struttura / Frame finish

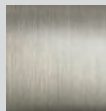

NI

LED Europe/International



D 9W - 34V - 1100lm/1200lm - 2700K/3000K - DIM2/DIM3

LED Usa & Canada



D 9W - 34V - 1100lm/1200lm - 2700K/3000K - DIM2/DIM3

Collezione / Collection



126

DIAMANTE

design Barbara Maggiolo 2003



Diamante PL G

DIAMANTE PL G



1x77W E27



USA & CANADA

1x60W E26

DIAMANTE FA

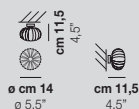

1x60W G9 / LED D



USA & CANADA

1x60W G9 / LED D

La collezione Diamante nasce da un processo esclusivamente artigianale. La particolare lavorazione viene esaltata dalla nuova versione LED. Le sospensioni presentate assieme o singolarmente donano all'ambiente un tocco raffinato.

The Diamante collection is the result of an exclusively artisanal process. The artisan manufacture is enhanced by the new LED version. The suspensions, presented as a cluster or individually, give the room a refined touch.

Finitura vetro / Glass finish

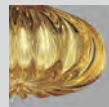

AM



CR

Finitura struttura / Frame finish

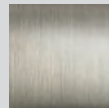

NI

LED Europe/International



D 9W - 34V - 1100lm/1200lm - 2700K/3000K - DIM2/DIM3

LED Usa & Canada



D 9W - 34V - 1100lm/1200lm - 2700K/3000K - DIM2/DIM3

Collezione / Collection



114

TUBES

design Matthias Hickl per Lissoni Associati 2005



Tubes PL 15

TUBES PL 20



1x77W E27



USA & CANADA

1x60W E26

TUBES PL 40

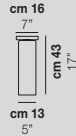

1x77W E27



USA & CANADA

1x60W E26

TUBES PL 60



1x77W E27



USA & CANADA

1x60W E26

Una serie di cinque elementi lineari di diversa lunghezza in vetro soffiato, che si possono usare come singole sospensioni, lampade a soffitto o in combinazioni multiple.

A series of five elements of straight lines in different lengths, made of mouth-blown glass, which can be used as standalone pendants and ceiling fixtures or in multiple combinations.

Finitura vetro / Glass finish

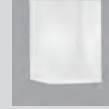

BC/LU

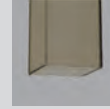

FU/TR

TUBES PL 90



1x77W E27



USA & CANADA

1x60W E26

TUBES PL 120



1x77W E27



USA & CANADA

1x60W E26

TUBES PL 9

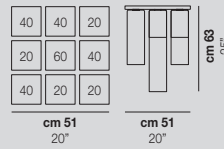

9x77W E27



USA & CANADA

9x60W E26

Finitura struttura / Frame finish

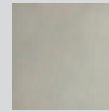

NO

TUBES PL 15

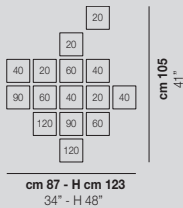

15x77W E27



USA & CANADA

15x60W E26

Collezione / Collection



DIADEMA

design Romani Sacconi Architetti Associati 2015



Diadema PL 80

DIADEMA PL 80

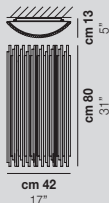

2x14W R7s LED



USA & CANADA

2x14W R7s LED

DIADEMA FA P

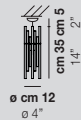

1x60W G9



USA & CANADA

1x60W G9



Luce in movimento. È la sensazione che invade l'ambiente quando si accende una Diadema. Il lavoro di Romani Saccani Architetti Associati, padri di questo progetto, si concentra dapprima sul singolo elemento della canna di vetro in cristallo per poi svilupparsi su un sistema composto: combinando canne di diverse dimensioni, la luce si riflette e trasmette la dinamicità desiderata. Numerose le varianti e le possibilità di personalizzazione. Tonalità del vetro in cristallo. Parti metalliche in finitura bronzo satinato e cromo.

Light in motion. That is the sensation pervading the environment when a Diadema is switched on. The work of Romani Saccani Architetti Associati, the fathers of this project, first concentrates on the single element of the glass rod and then develops on a composite system: by combining rods of different sizes, the light is reflected and conveys the desired dynamism. Several variants and possibilities for customization are available. Crystal glass shade. Metal parts finishing in satin bronze and chrome.

Finitura vetro / Glass finish



CR

Finitura struttura / Frame finish



BS

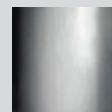

CR

Collezione / Collection



196



324



367



391



ECOS

design Renato Toso, Noti Massari & Associati 2007



Ecos PL 90

ECOS PL 60A

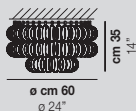

3x77W E27



USA & CANADA

3x60W E26

ECOS PL 90

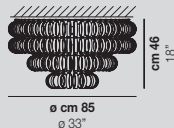

5x77W E27



USA & CANADA

5x60W E26



Un anello, infinite combinazioni. La matrice da cui nasce l'idea della collezione Ecos è una sola: l'anello di vetro. Le declinazioni cromatiche e di texture che i designer Renato Toso, Noti Massari e Associati hanno saputo ricavare da questo semplice elemento sono davvero molte. Questo rende la collezione estremamente personalizzabile in termini di forme e misure, per un'illuminazione davvero originale. Tonalità del vetro bianco o cristallo con lavorazione rigadin. Parti metalliche in finitura bronzo satinato e cromo.

One ring, infinite combinations. The concept of the Ecos collection is just in one element: the glass ring. The chromatic and texture variations that the designers Renato Toso, Noti Massari e Associati have been able to obtain from this simple element are several. That makes the collection extremely customizable in terms of shapes and sizes, for a truly original lighting. Rigadin white or crystal colour glass. Metal parts finishing in satin bronze and chrome.

Finitura vetro / Glass finish

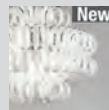

BC/RI

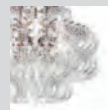

CR/RI

Finitura struttura / Frame finish



BS

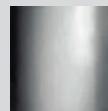

CR

Collezione / Collection



204



328



390

GIOGALI

design Angelo Mangiarotti 1967



Giogali PL CA1



Giogali PL CA3



GIOGALI PL 35

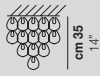

o cm 35
o 14"

2x60W E14



USA & CANADA

2x40W E12

GIOGALI PL 50

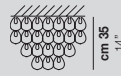

o cm 50
o 20"

4x77W E27



USA & CANADA

4x60W E26

GIOGALI PL 60

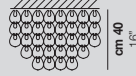

o cm 60
o 24"

4x77W E27



USA & CANADA

4x60W E26

GIOGALI PL 65Q

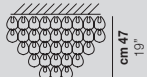

cm 65
26"

4x77W E27



USA & CANADA

4x60W E26

GIOGALI PL 80

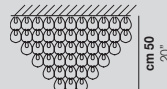

o cm 80
o 31"

5x77W E27



USA & CANADA

5x60W E26

GIOGALI PL CA1

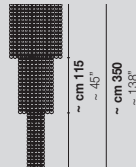

o cm 100
o 39"

10x77W E27



USA & CANADA

10x60W E26

GIOGALI PL CA2

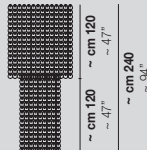

o cm 100
o 39"

10x77W E27



USA & CANADA

10x60W E26

GIOGALI PL CA3

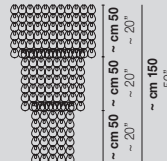

o cm 80
o 31"

7x77W E27



USA & CANADA

7x60W E26

Un elemento, puro: il gancio di cristallo. È l'intuizione di un Maestro del design italiano come Angelo Mangiarotti che, nel 1967, dà origine al best seller del catalogo Vistosi, Giogali. Un intreccio iconico applicato alla versione che si preferisce.

A pure element: the crystal hook. It is the intuition of a master of Italian design, Angelo Mangiarotti, who in 1967 created the best seller of the Vistosi catalogue, Giogali. An iconic interweaving applied to the version one prefers.

Finitura vetro / Glass finish



BC



CR/AG



CR/AM



CR/BR



CR/FU



CR/NN



CR/OR



CR/RA



CR/TR



NE

Finitura struttura / Frame finish

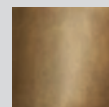

BR



CR

Collezione / Collection



210



332



392

MINIGIOGALI

design Angelo Mangiarotti 1967 - restyling 2009



Minigiogali PL 35 / 50



Minigiogali PL 60 / 65Q



MINIGIOGALI PL 35

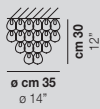

2x60W E14
CE ENEC CB ENEC PS
 USA & CANADA
 2x40W E12

MINIGIOGALI PL 50

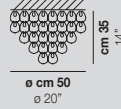

4x77W E27
CE ENEC CB ENEC PS
 USA & CANADA
 4x60W E26

MINIGIOGALI PL 60

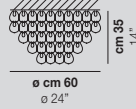

4x77W E27
CE ENEC CB ENEC PS
 USA & CANADA
 4x60W E26

MINIGIOGALI PL 65Q

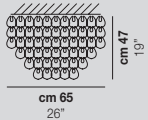

4x77W E27
CE ENEC CB ENEC PS
 USA & CANADA
 4x60W E26

MINIGIOGALI PL 80

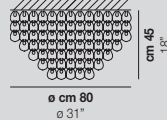

5x77W E27
CE ENEC CB ENEC PS
 USA & CANADA
 5x60W E26

MINIGIOGALI PL CA3

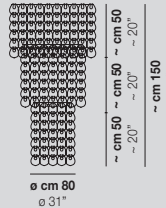

7x77W E27
CE ENEC CB ENEC PS
 USA & CANADA
 7x60W E26

La versione ridotta di Giogali, che permette di impiegare i ganci in cristallo per installazioni a parete di minori dimensioni, standard o su misura.

The small size version of Giogali, which allows the use of glass hooks for smaller, standard or custom-made wall installations.

Finitura vetro / Glass finish



NE

Finitura struttura / Frame finish

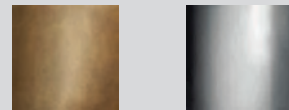

BR

CR

Collezione / Collection



Parete / Wall

Sospensioni / <i>Suspensions</i>	29
Plafoniere / <i>Ceiling</i>	225
Tavolo / <i>Table</i>	335
Terra / <i>Floor</i>	371



Parete / Wall



Armonia
300

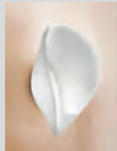

Balance
306



Cloth
317

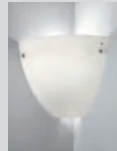

Corner
310



Dafne
312

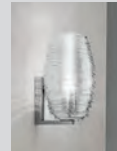

Damasco
318

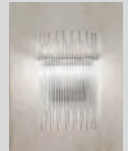

Diadema
324



Ecos
328

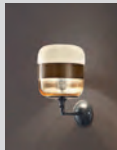

Futura
305



Giogali
332

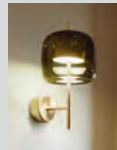

Jube
298

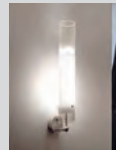

Lio
322

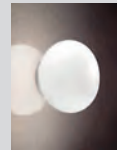

Lucciola
308

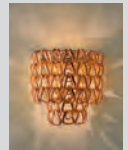

Minigiogali
330



Neochic
294

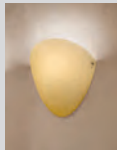

Ovalina
314

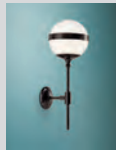

Peggy
290

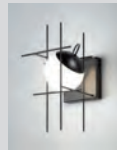

Plot Frame
292



Puppet
316

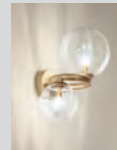

Puppet Ring
296

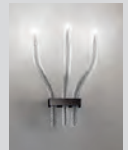

Stardust
320



Tread
302



Vega
304

PEGGY

design Hangar Design Group 2017



Peggy AP

PEGGY AP

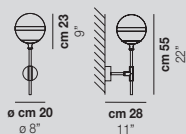

1x60W E14



USA & CANADA

1x40W E12

Il bianco e il nero. Da questa polarità cromatica e materica nasce Peggy. Il progetto illuminotecnico concilia la leggerezza del vetro soffiato bianco lucido, lavorato interamente a mano, con il carattere più vivace del metallo lucido nero o dell'ottone antico. Il connubio di grande effetto comunica razionalità e eleganza al tempo stesso.

White and black. Peggy was created starting from this chromatic and material polarity. This lighting design combines the lightness of glossy white blown glass, entirely handmade, with the liveliest character of the glossy metal black or antique brass. This effective combination conveys rationality and elegance at the same time.

Finitura vetro / Glass finish

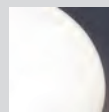

BC/LU

Finitura struttura / Frame finish

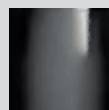

NEL



OT



Collezione / Collection



56



378

PLOT FRAME

design Chiaramonte & Marin 2019



Plot Frame AP

PLOT FRAME AP 1

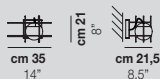

1x11,5W LED 09

CE EAC

USA & CANADA cULus

1x8,5W LED 09

L'ispirazione dalla quale nasce la linea Plot frame è la semplicità della sfera e il tentativo di rappresentarne il movimento. Una trama metallica all'interno della quale sfere di vetro luminescenti sono quasi libere di muoversi consentendo al fruitore di interagire con l'oggetto. Montatura nera opaca. Sorgente luminosa LED.

The inspiration behind Plot Frame is to render the motion and simplicity of a sphere. A metal weave where luminescent glass spheres are almost free to move, allowing the user to interact with the object. Matt black frame. LED light source.

Finitura vetro / Glass finish

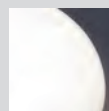

BC/LU

Finitura struttura / Frame finish

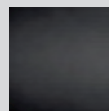

NEO

LED Europe/International

CE EAC

09 11,5W - 25V - 1600lm - 2700K/3000K - DIM2/DIM3

LED Usa & Canada

cULus

09 8,5W - 25V - 1250lm - 2700K/3000K - DIM2/DIM3



Collezione / Collection



68



374

NEOCHIC

design Chiaramonte & Marin 2013



Neochic PP P / M / G / R

NEOCHIC PP P

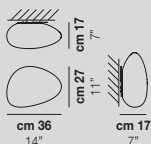

1x77W E27 / **LED F**
 CE
 USA & CANADA
 1x60W E26 / **LED F**

NEOCHIC PP M

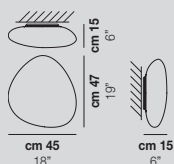

2x77W E27 / **LED G**
 CE
 USA & CANADA
 2x60W E26 / **LED G**

NEOCHIC PP G

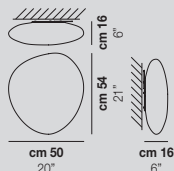

2x77W E27 / **LED G**
 CE
 USA & CANADA
 2x60W E26 / **LED G**

Le curve morbide e la superficie levigata incontrano il vetro soffiato in un modello di estrema semplicità, adatto a qualsiasi contesto d'arredo.

Soft curves and a polished surface meet blown glass in a model of extreme simplicity, suitable for any context.

Finitura vetro / Glass finish

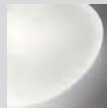

BC/ST

Finitura struttura / Frame finish



BC

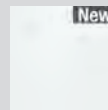

BO*

LED version: BO*

NEOCHIC PP R

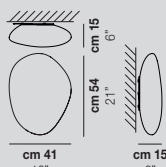

2x77W E27 / **LED G**
 CE
 USA & CANADA
 2x60W E26 / **LED G**



LED Europe/International

CE ENEC

F 12W - 24V - 1700lm - 2700K/3000K - DIM2/DIM3

G 19W - 39V - 2850lm - 2700K/3000K - DIM2/DIM3

LED Usa & Canada

F 12W - 24V - 1700lm - 2700K/3000K - DIM2/DIM3

G 19W - 39V - 2850lm - 2700K/3000K - DIM2/DIM3

Collezione / Collection

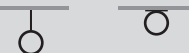

136

236

PUPPET RING

design Romani Sacconi Architetti Associati 2019



PUPPET RING AP 2

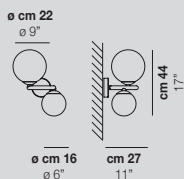

2x60W G9



USA & CANADA



2x60W G9



L'elemento distintivo di questo modello della collezione Puppet Ring sono gli anelli con diametro crescente, che possono essere accostati con sequenze differenti per costituire l'armatura su cui andare ad appoggiare le preziose sfere in vetro di tre dimensioni differenti che si fondono con la struttura grazie ad una preformatura interna al vetro soffiato. Esteticamente leggero ed elegante, Puppet Ring coniuga in modo etereo vetro cristallo, fumé, ambra e bianco sfumato con finiture oro e nickel nero satinato.

The distinctive feature of this model from the Puppet Ring collection are the rings with increasing diameter. They can be combined in different sequences to form the framework on which the precious glass spheres in three different sizes are placed, blending with the structure thanks to a preformation inside the blown glass. Aesthetically light and elegant, Puppet Ring ethereally combines crystal, smoky, amber and shaded white glass with gold and black matt nickel finishes.

Finitura vetro / Glass finish

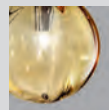

AM/TR



BC/SF

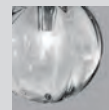

CR/TR

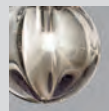

FU/TR

Finitura struttura / Frame finish

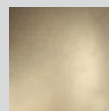

BKS

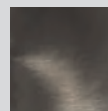

NNS

Collezione / Collection



40

JUBE

design Favaretto&Partners 2017



Jube AP S



JUBE APS

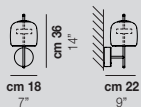

1x8,5W LED 14



USA & CANADA

1x8,5W LED 14



L'aspetto elegante e delicato del vetro soffiato trova in Jube una nuova dimensione. Due vetri accostati, perfettamente assemblati, da sembrare un pezzo unico. Una lampada sinuosa, con colori tono su tono che le regalano un prezioso mood vintage.

The elegant and delicate look of the blown glass finds a new dimension in Jube. Two glass units placed side by side, so perfectly assembled, that they look like a unique piece. A sinuous lamp, with tone-on-tone colours that give it a precious, vintage mood.

Finitura vetro / Glass finish



Finitura struttura / Frame finish

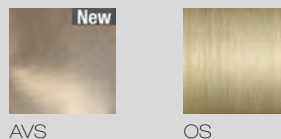

LED Europe/International

14 8,5W - 24V - 1200lm - 2700K/3000K - DIM2/DIM3

LED Usa & Canada

14 8,5W - 24V - 1200lm - 2700K/3000K - DIM2/DIM3

Collezione / Collection

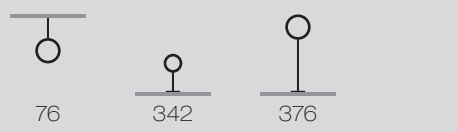

archiproducts
DESIGN AWARDS
WINNER 2020

JUBE 2020

ARMONIA

design Francesco Lucchese 2019



Armonia AP 25

ARMONIA AP 25

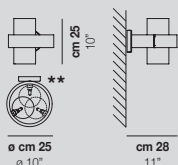

1x60W G9



USA & CANADA

1x60W G9

** Diffusore posizionabile frontalmente, lato dx e lato sx
Diffuser can be positioned frontally, right side and left side

Una collezione dai connotati contemporanei che racchiude preziosi contenuti storici della lavorazione del vetro quali il "balloton" e il rigadin dritto e ritorto.

A collection with contemporary connotations that contains precious historical features: that of glass processings such as the "balloton" and the straight and twisted rigadin.

Finitura vetro / Glass finish



vetro piccolo: ambra rigadin
small glass: striped amber glass

AM/RI



vetro piccolo: cristallo rigadin
small glass: striped crystal glass

CR/RI



vetro piccolo: fumè rigadin
small glass: smoky striped glass

FU/RI

Finitura struttura / Frame finish

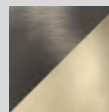

N_O



N_R



ARMONIA 2020

Collezione / Collection



110

TREAD

design Chiaramonte & Marin 2019



Tread AP

TREAD AP

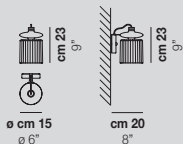

1x12W LED 13

CE ENEC

USA & CANADA 

1x12W LED 13



La "tecnicità" dell'elemento metallico unito al diffusore in vetro soffiato conferisce a Tread uno stile "industriale". Un oggetto che ricorda le apparecchiature elettriche vintage per la sua forma particolare, in cui il dissipatore alettato, unito al vetro soffiato, diviene elemento caratterizzante. Tread crea un'atmosfera all'avanguardia e di stile coniugando il vetro cristallo, fumé, terra bruciata e verde antico trasparente con finiture rame, oro e bronzo satinato.

The "technicity" of the metal element combined with the blown glass diffuser gives Tread an "industrial" style. An object reminiscent of vintage electrical equipment for its particular shape, in which the finned heat sink, combined with blown glass, becomes a distinctive element. Tread creates an avant-garde and stylish atmosphere by combining crystal, smoky, burned earth and transparent old green glass with copper, gold and bronze matt finishes.

Finitura vetro / Glass finish

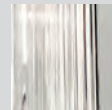

CR/TR



FU/TR

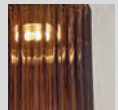

TB/TR

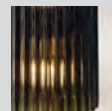

VA/TR

Finitura struttura / Frame finish

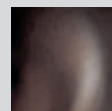

BHS

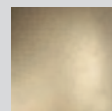

BKS

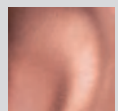

RAS

LED Europe/International 

13 12W - 35V - 1500lm/1600lm - 2700K/3000K - DIM2/DIM3

LED Usa & Canada 

13 12W - 35V - 1500lm/1600lm - 2700K/3000K - DIM2/DIM3

Collezione / Collection



82



352



Vega AP

VEGA

design Michele De Lucchi 1982

La collezione Vega si distingue per le sue forme essenziali dal sapore vintage. Il vetro soffiato proposto in tre colori diversi ospita un nuovo attacco lampadina che consente l'utilizzo di sorgenti LED. Anche la parte superiore del diffusore che permette di orientare la lampada è in vetro soffiato incamiciato.

The Vega collection stands out for its essential shapes with a vintage mood. The blown glass, proposed in three different colours, has a new bulb socket fitting for LED sources. The upper part of the diffuser, which allows to orient the lamp, is in blown encased glass.

Finitura vetro / Glass finish



BC

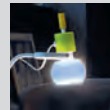

MC/1

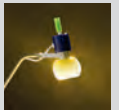

MC/2

Finitura struttura / Frame finish



BC



VEGA AP



1x60W G9



USA & CANADA

1x60W G9



Collezione / Collection





Futura AP

FUTURA AP P

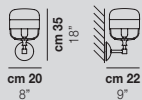

1x77W E27



USA & CANADA

1x60W E26



FUTURA

design Hangar Design Group 2015

Collezione di lampade costituite da un pezzo unico di vetro soffiato la cui particolare lavorazione però permette un doppio effetto cromatico: trasparente nella parte superiore, effetto satinato nella parte inferiore. Sono disponibili le seguenti possibilità di abbinamento vetro con anello metallico: vetro bianco con anello nero opaco, vetro fumé con anello marrone, vetro ambra con anello ottone. Nuova finitura vetro cristallo trasparente con possibilità di abbinare anello rame o nero opaco.

A collection of lamps made from a single piece of blown glass, whose particular workmanship, though, allows a double chromatic effect: transparent at the top, satin effect at the bottom. The following combinations of glass with metal ring are now available: white glass combined with matt black ring, smoky glass with brown ring, amber glass with painted brass ring. A new transparent crystal glass finish with copper or matt black ring is also available.

Finitura vetro / Glass finish



AM/OT



BC/NE



CR/NE New



CR/RA New

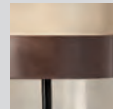

FU/MA

Finitura struttura / Frame finish

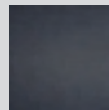

NE

Collezione / Collection



BALANCE
design Pio e Tito Toso 2011



BALANCE PP 24

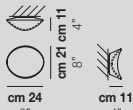

1x46W E14



USA & CANADA

1x40W E12

BALANCE PP M

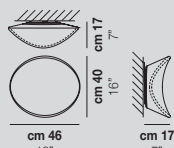

2x77W E27 / LED G



USA & CANADA

2x60W E26 / LED G

BALANCE PP G

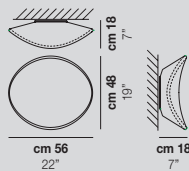

2x77W E27 / LED G



USA & CANADA

2x60W E26 / LED G

La traiettoria delle orbite planetarie intorno al sole ispira questa collezione, che ripropone il movimento creato dall'armonia e dall'equilibrio di forze invisibili con vetro e luce. Disponibile in tre dimensioni.

The elliptical orbit of a planet around the sun inspires this collection, which reminds of the movement created by the harmony and balance of invisible forces with glass and light. Available in three sizes.

Finitura vetro / Glass finish

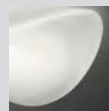

BC/LU

Finitura struttura / Frame finish



BC



BO*

LED version: BO*

LED Europe/International



G 19W - 39V - 2850 lm - 2700K/3000K - DIM2/DIM3

LED Usa & Canada



G 19W - 39V - 2850 lm - 2700K/3000K - DIM2/DIM3



Collezione / Collection

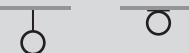

144

232



Lucciola FA 18 / PP 27 / PP P / PP M

LUCCIOLA FA 18

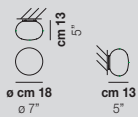

1x48W E14



USA & CANADA

1x40W E12

LUCCIOLA PP 27

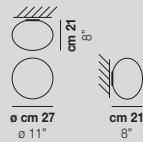

1x48W E14



USA & CANADA

1x40W E12

LUCCIOLA PP P

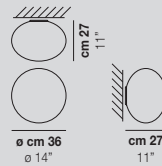

1x77W E27 / LED F



USA & CANADA

1x60W E26 / LED F

LUCCIOLA PP M

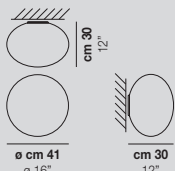

3x77W E27 / LED F



USA & CANADA

3x60W E26 / LED F

Una delle più versatili collezioni. La sua forma ovale in vetro soffiato satinato è disponibile in diverse dimensioni, che si prestano a innumerevoli combinazioni d'installazione.

One of our most versatile collections. The oval and mouth-blown satin glass shape is available in different sizes, which can be combined to offer countless installation combinations.

Finitura vetro / Glass finish



BC/ST

Finitura struttura / Frame finish



BC

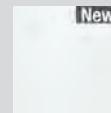

BO*

LED version: BO*

LED Europe/International



F 12W - 24V - 1700lm - 2700K/3000K - DIM2/DIM3

LED Usa & Canada



F 12W - 24V - 1700lm - 2700K/3000K - DIM2/DIM3

Collezione / Collection

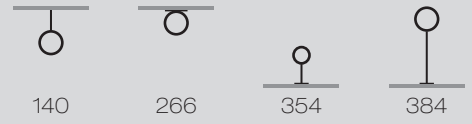

140

266

354

384

CORNER

studio tecnico Vetreria Vistosi 1993



Corner AP

CORNER AP

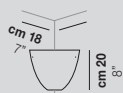

1x77W E27



USA & CANADA

1x60W E26

La forma ideata per uno spazio angolare rendono Corner perfetta per ambienti dalla luce soffusa, come le stanze da letto. Disponibile in cinque colori e due diverse finiture lucido e satinato.

The shape of Corner makes it suitable for rooms with soft lighting, such as bedrooms. Available in five colours and two different finishes, glossy and matt.

Finitura vetro / Glass finish

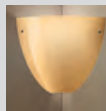

AM/LU

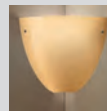

AM/ST

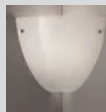

BC/LU

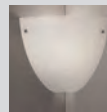

BC/ST

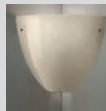

FU/LU

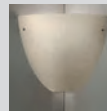

FU/ST

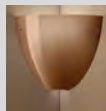

TB/LU

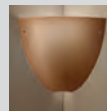

TB/ST



TB/LU



TB/ST

DAFNE

studio tecnico Vetreria Vistosi 1993



Dafne AP

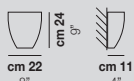

1x77W E27



USA & CANADA

1x60W E26

Le linee eleganti e discrete di Dafne ne fanno una lampada da parete adatta ad ogni tipo di ambiente. Disponibile in cinque colori e due diverse finiture lucido e satinato.

This wall lamp offers an elegant and discreet design that makes it suitable for every type of environment. Available in five colours and two different finishes, glossy and matt.

Finitura vetro / Glass finish

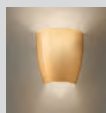

AM/LU

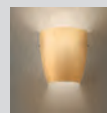

AM/ST

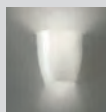

BC/LU

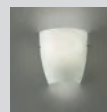

BC/ST

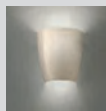

FU/LU

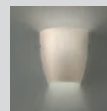

FU/ST

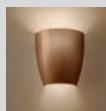

TB/LU

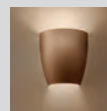

TB/ST



AM/LU

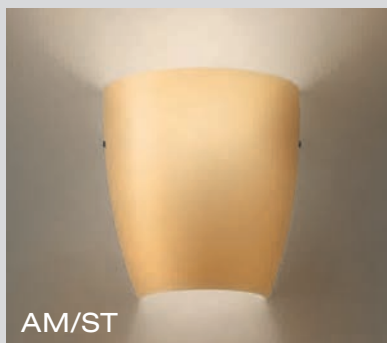

AM/ST

OVALINA

studio tecnico Vetreria Vistosi 1993



Ovalina AP

OVALINA AP



1x77W E27



USA & CANADA

1x60W E26

Un design discreto ed essenziale per esaltare la resa del vetro soffiato satinato o lucido in quattro colori diversi.

A discreet and essential design that enhances the quality of the satin or glossy blown glass in four different colours.

Finitura vetro / Glass finish

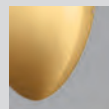

AM/LU

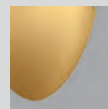

AM/ST



BC/LU

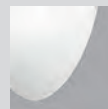

BC/ST



FU/LU

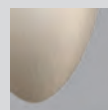

FU/ST

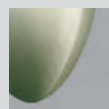

VA/LU

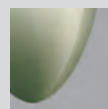

VA/ST

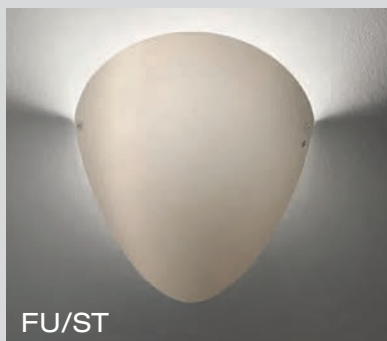



Puppet AP P

PUPPET

design Romani Sacconi Architetti 2015

Collezione di lampade in vetro soffiato e rigato irregolarmente. Le sfere di tre dimensioni differenti e le diverse altezze dei cavi sono studiate per creare eleganti composizioni. La versione chandelier permette di fissare a piacere a soffitto i diffusori con cavetti d'acciaio creando giochi sempre diversi.

Collection of lamps with a blown and irregular striped glass diffuser. The three sizes of the spheres and the different cable heights are designed to create elegant compositions. The chandelier version allows to fix the diffusers with steel cables to the ceiling, creating different games.

Finitura vetro / Glass finish

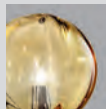

AM/TR

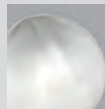

BC/SF

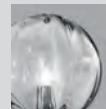

CR/TR

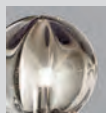

FU/TR

Finitura struttura / Frame finish

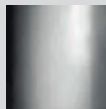

CR

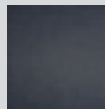

NE

PUPPET AP P

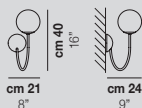

1x60W G9

CE ENEC

USA & CANADA

1x60W G9

Collezione / Collection



32



361



Cloth AP G

CLOTH

design Romani Saccani Architetti 2009

La complessa soffiatura di Cloth trasforma il vetro in un tessuto increspato, di grande effetto. Nella versione cromata, grazie ad un'esclusiva finitura esterna, Cloth è metallizzata quando è spenta, e assume un tono caldo beige scuro quando viene accesa.

A unique blown glass that seems to turn into pleated fabric, making this collection a real eye catcher. The chrome version has an exclusive outer chrome coating that looks metallic when the lamp is off, but turns to dark beige when the lamp is on.

Finitura vetro / Glass finish



BC/CM

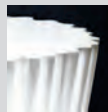

BC/ST

Finitura struttura / Frame finish



CR

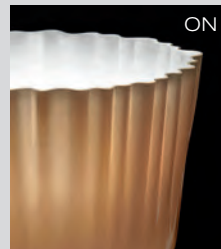
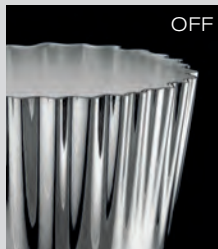

CLOTH AP G

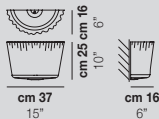

1x77W E27

CE CB EAC

USA & CANADA

1x60W E26

Collezione / Collection



158

DAMASCO
design Paolo Crepax 2003



Damasco AP G

DAMASCO AP 1A P

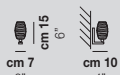

1x60W G9



USA & CANADA

1x60W G9

DAMASCO AP 2A P

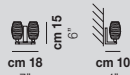

2x60W G9



USA & CANADA

2x60W G9

DAMASCO AP G

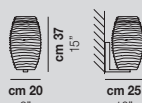

1x77W E27



USA & CANADA

1x60W E26

Collezione realizzata con la tecnica a bozzolo, in cui l'originale decoro diventa un vero e proprio materiale: la sovrapposizione di fili di vetro fuso a creare una texture in rilievo. Damasco è una delle creazioni di più lungo successo, che vede nel tempo versioni sempre nuove.

The collection is produced with the bozzolo technique: that consists in applying threads of molten glass to create an organic texture.

Damasco is one of our most successful series, which has been developed and extended during the years with new versions.

Finitura vetro / Glass finish

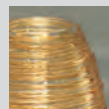

CR/AM



CR/CR

Finitura struttura / Frame finish

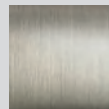

NI



AP 2A P

Collezione / Collection

168	268	365	388

STARDUST

design Francesco Lucchese 2015



Stardust AP 3



Stardust AP 1

Collezioni di lampade con bracci in vetro soffiato e lavorato a mano. Le strutture in metallo nascondono un originale sistema di fissaggio dei bracci e del sistema di cablaggio.

Collections of lamps with arms made of blown and handcrafted crystal glass. The metal frames hide an original fastening system of the arms and of the cabling system.

Finitura vetro / Glass finish



CR/RI

Finitura struttura / Frame finish

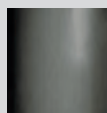

NN

STARDUST AP 1

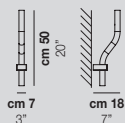

1×60W G9



USA & CANADA .UL

1×60W G9

STARDUST AP 3

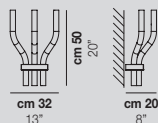

3×60W G9



USA & CANADA .UL

3×60W G9

Collezione / Collection



164

LIO

archivio storico Vetreria Vistosi 1972



Lio AP 48

LIO PP 30

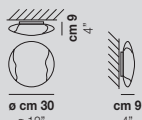

1x77W E27 / LED F



USA & CANADA .cUL.us

1x60W E26 / LED F

LIO PP 40

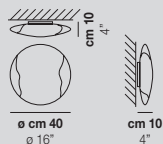

1x77W E27 / LED F



USA & CANADA .cUL.us

1x60W E26 / LED F

LIO PP 50

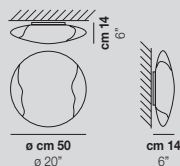

2x77W E27 / LED G



USA & CANADA .cUL.us

2x60W E26 / LED G

Collezione dal design minimalista e discreto che esalta la sorgente luminosa, grazie alla fascia di vetro traslucida imprigionata tra gli strati del cristallo.

The minimal and unobtrusive design of this collection enhances the light source thanks to the translucent glass band trapped between the crystal layers.

Finitura vetro / Glass finish



CR/BC

LIO AP L1 P

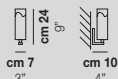

1x60W G9



USA & CANADA .cUL.us

1x60W G9

LIO AP L2 P

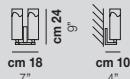

2x60W G9



USA & CANADA .cUL.us

2x60W G9

LIO AP 48

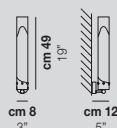

1x77W E27



USA & CANADA .cUL.us

1x60W E26

Finitura struttura / Frame finish



BC



BO*

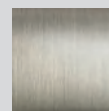

NI

LED version: BO*

LED Europe/International



F 12W - 24V - 1700 lm - 2700K/3000K - DIM2/DIM3

G 19W - 39V - 2850 lm - 2700K/3000K - DIM2/DIM3

LED Usa & Canada



F 12W - 24V - 1700 lm - 2700K/3000K - DIM2/DIM3

G 19W - 39V - 2850 lm - 2700K/3000K - DIM2/DIM3

Collezione / Collection

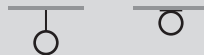

178

256

358

DIADEMA

design Romani Saccani Architetti Associati 2015



Diadema AP G



Diadema AP P



DIADEMA AP P

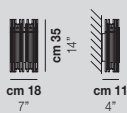

2x60W G9



USA & CANADA 

2x60W G9

DIADEMA AP G

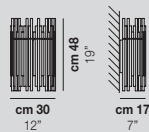

2x77W E27



USA & CANADA 

2x60W E26

DIADEMA AP L

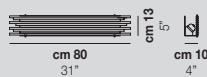

2x8W R7s LED



USA & CANADA

2x8W R7s LED

DIADEMA AP K3

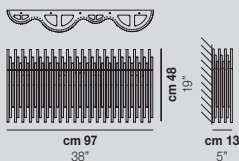

4x60W G9



USA & CANADA 

4x60W G9

Luce in movimento. È la sensazione che invade l'ambiente quando si accende una Diadema. Il lavoro di Romani Saccani Architetti Associati, padri di questo progetto, si concentra dapprima sul singolo elemento della canna di vetro in cristallo per poi svilupparsi su un sistema composto: combinando canne di diverse dimensioni, la luce si riflette e trasmette la dinamicità desiderata. Numerose le varianti e le possibilità di personalizzazione. Tonalità del vetro in cristallo. Parti metalliche in finitura bronzo satinato e cromo.

Light in motion. That is the sensation pervading the environment when a Diadema is switched on. The work of Romani Saccani Architetti Associati, the fathers of this project, first concentrates on the single element of the glass rod and then develops on a composite system: by combining rods of different sizes, the light is reflected and conveys the desired dynamism. Several variants and possibilities for customization are available. Crystal glass shade. Metal parts finishing in satin bronze and chrome.

Finitura vetro / Glass finish



CR

Finitura struttura / Frame finish



BS

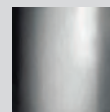

CR

Collezione / Collection

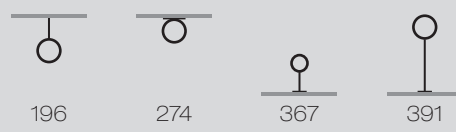

196

274

367

391



ECOS

design Renato Toso, Noti Massari & Ass.ti 2007

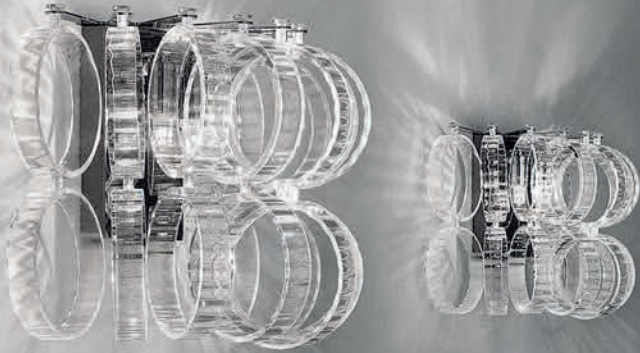

Ecos AP 35

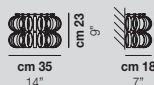

2x60W G9



USA & CANADA

2x60W G9



Un anello, infinite combinazioni. La matrice da cui nasce l'idea della collezione Ecos è una sola: l'anello di vetro. Le declinazioni cromatiche e di texture che i designer Renato Toso, Noti Massari e Associati hanno saputo ricavare da questo semplice elemento sono davvero molte. Questo rende la collezione estremamente personalizzabile in termini di forme e misure, per un'illuminazione davvero originale. Tonalità del vetro bianco o cristallo con lavorazione rigadin. Parti metalliche in finitura bronzo satinato e cromo.

One ring, infinite combinations. The concept of the Ecos collection is just in one element: the glass ring. The chromatic and texture variations that the designers Renato Toso, Noti Massari e Associati have been able to obtain from this simple element are several. That makes the collection extremely customizable in terms of shapes and sizes, for a truly original lighting. Rigadin white or crystal colour glass. Metal parts finishing in satin bronze and chrome.

Finitura vetro / Glass finish



BC/RI



CR/RI

Finitura struttura / Frame finish



BS

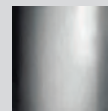

CR

Collezione / Collection



204



276



390

MINIGIOGALI

design Angelo Mangiarotti 1967 - restyling 2009



Minigiogali AP

MINIGIOTALI AP

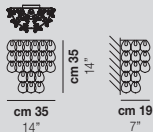

1x60W E14



USA & CANADA

1x60W E12

MINIGIOTALI AP 2

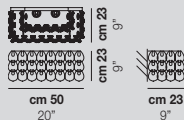

2x77W E27



USA & CANADA

2x60W E26

La versione ridotta di Giogali, che permette di impiegare i ganci in cristallo per installazioni a parete di minori dimensioni, standard o su misura.

The small size version of Giogali, which allows the use of glass hooks for smaller, standard or custom-made wall installations.

Finitura vetro / Glass finish

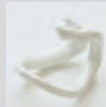

BC



CR/AG



CR/AM



CR/BR



CR/FU



CR/NN

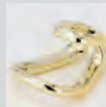

CR/OR

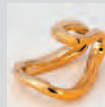

CR/RA



CR/TR



NE

Finitura struttura / Frame finish

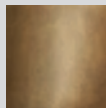

BR



CR

Collezione / Collection



218



282



368



393

GIOGALI
design Angelo Mangiarotti 1967



Giogali AP 2

GIOGALI AP

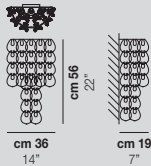

1x60W E14



USA & CANADA

1x40W E12

GIOGALI AP 2

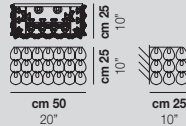

2x77W E27



USA & CANADA

2x60W E26

Un elemento, puro: il gancio di cristallo. È l'intuizione di un Maestro del design italiano come Angelo Mangiarotti che, nel 1967, dà origine al best seller del catalogo Vistosi, Giogali. Un intreccio iconico applicato alla versione che si preferisce.

A pure element: the crystal hook. It is the intuition of a master of Italian design, Angelo Mangiarotti, who in 1967 created the best seller of the Vistosi catalogue, Giogali. An iconic interweaving applied to the version one prefers.

Finitura vetro / Glass finish



BC



CR/AG



CR/AM



CR/BR



CR/FU



CR/NN



CR/OR



CR/RA



CR/TR



NE

Finitura struttura / Frame finish

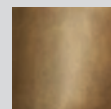

BR



CR

Collezione / Collection



210



278



392

Tavolo / Table

Sospensioni / <i>Suspensions</i>	29
Plafoniere / <i>Ceiling</i>	225
Parete / <i>Wall</i>	287
Terra / <i>Floor</i>	371



Tavolo / Table

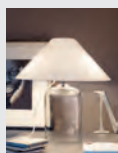

Alega
348



Assiba
359



Bissona
357



Bolle
364



Damasco
365

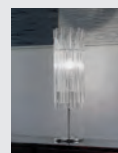

Diadema
367

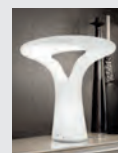

Ferea
356

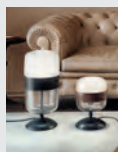

Futura
353

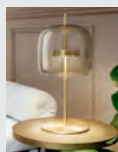

Jube
342



Lio
358

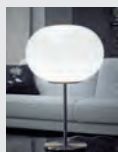

Lucciola
354



Minigiogali
368

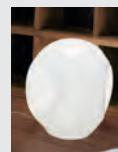

Munega
360

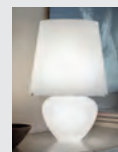

Naxos
362



Nessa
349

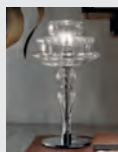

Novecento
366

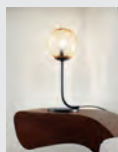

Puppet
361



Riflesso
338

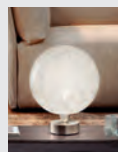

Rina
346

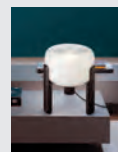

Sata
350

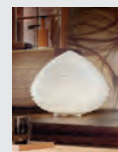

Spirit
369

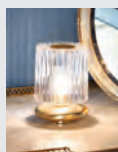

Tread
352

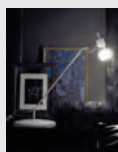

Vega
351

RIFLESSO

design Chiaramonte & Marin 2019



Riflesso LT 2



Rifleso LT 2 / LT 1



RIFLESSO LT 1

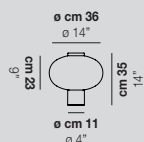

1x10,5W LED 05

CE ENEC

USA & CANADA

1x10,5W LED 05

RIFLESSO LT 2

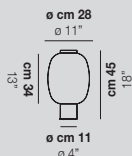

1x10,5W LED 05

CE ENEC

USA & CANADA

1x10,5W LED 05

RIFLESSO LT 3

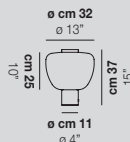

1x10,5W LED 05

CE ENEC

USA & CANADA

1x10,5W LED 05

Nella collezione Riflesso la semplicità e la leggerezza del vetro diventano protagoniste in tre diverse forme sinuose. Le silhouette del diffusore vengono esaltate dalla sorgente luminosa a LED. Le sospensioni presentate assieme o singolarmente caratterizzano l'ambiente con eleganza.

In the Riflesso collection the simplicity and lightness of glass become the main features with three different sinuous shapes. The silhouettes of the diffuser are enhanced by the LED light source. The suspensions, presented together or individually, characterise the environment with elegance.

Finitura vetro / Glass finish



AA/TR



AM/TR



CR/TR

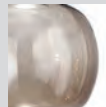

FU/TR

LT 1 solo AM/TR, CR/TR / LT 1 only AM/TR, CR/TR

LT 2 solo CR/TR, FU/TR / LT 2 only CR/TR, FU/TR

LT 3 solo AA/TR, CR/TR / LT 3 only AA/TR, CR/TR

Finitura struttura / Frame finish

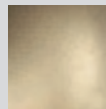

BKS

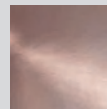

RAV

LED Europe/International CE ENEC

05 10,5W - 35V - 1400lm - 2700K/3000K - DIM4

LED Usa & Canada

05 10,5W - 35V - 1400lm - 2700K/3000K - DIM4



LT 3 / LT 1



archiproducts
DESIGN AWARDS
WINNER 2019

RIFLESSO 2019

Collezione / Collection



52

JUBE

design Favaretto&Partners 2017



Jube LT G



Jube LT P



JUBE LT S

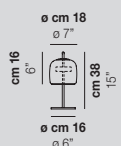

1x8,5W LED 16



USA & CANADA

1x8,5W LED 16

JUBE LT P

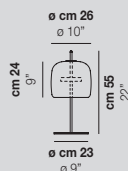

1x13W LED 15



USA & CANADA

1x13W LED 15

JUBE LT G

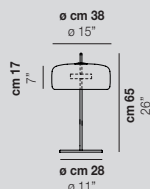

1x13W LED 15



USA & CANADA

1x13W LED 15

L'aspetto elegante e delicato del vetro soffiato trova in Jube una nuova dimensione. Due vetri accostati, perfettamente assemblati, da sembrare un pezzo unico. Una lampada sinuosa, con colori tono su tono che le regalano un prezioso mood vintage.

The elegant and delicate look of the blown glass finds a new dimension in Jube. Two glass units placed side by side, so perfectly assembled, that they look like a unique piece. A sinuous lamp, with tone-on-tone colours that give it a precious, vintage mood.

Finitura vetro / Glass finish



AA/TR



CR/TR



FU/TR

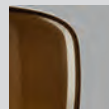

TB/TR



VA/TR

Finitura struttura / Frame finish



AVS

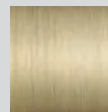

OS



LED Europe/International 

15 13W - 37V - 2000lm - 2700K/3000K - DIM4

16 8,5W - 24V - 1200lm - 2700K/3000K - DIM4

LED Usa & Canada

15 13W - 37V - 2000lm - 2700K/3000K - DIM4

16 8,5W - 24V - 1200lm - 2700K/3000K - DIM4

Collezione / Collection



76



298



376



archiproducts
DESIGN AWARDS
WINNER 2020

JUBE LT 2020

RINA

design Barbara Maggiolo 2009



Rina LT 45

RINA LT 16



1x60W G9



USA & CANADA

1x60W G9

RINA LT 25



1x77W E27



USA & CANADA

1x60W E26

RINA LT 35

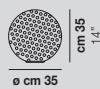

1x77W E27



USA & CANADA

1x60W E26

Si ispira al tarassaco, del quale ricorda il pappo, grazie alla leggera texture della superficie, realizzata con la tradizionale tecnica delle murrine. Rina è disponibile in diverse misure che si possono combinare in un'ampia gamma di installazioni.

Rina is inspired by the dandelion, of which it recalls the pappus, thanks to the light texture of the surface, made with the traditional technique of murrine. It is available in different sizes that can be combined in a wide range of installations.

RINA LT 45

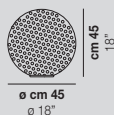

1x77W E27



USA & CANADA

1x60W E26

Finitura vetro / Glass finish



BC/MU

Finitura struttura / Frame finish

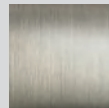

NI



Collezione / Collection



98



242

ALEGA

design Vico Magistretti 1970

Ispirazione retrò e idea del classico nello stesso design. La combinazione della base trasparente con il diffusore bianco dona un tono caldo alla luce.

A design combining a classical concept with a retro inspiration. The transparent base and the white diffuser give a warm light.

Finitura vetro / Glass finish

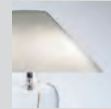

BC/CR

Finitura struttura / Frame finish



CR



ALEGA LT

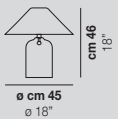

3x46W E14



USA & CANADA

3x46W E12

NESSA

design Vistosi 1972

Lampada da tavolo essenziale nella forma, preziosa per la sua lavorazione artigianale. La fascia inferiore trasparente sfrutta al massimo la sorgente luminosa, mentre il resto del corpo in vetro bianco lascia filtrare una luce perfetta per ambienti soft.

A table lamp essential in its form, precious for its craftsmanship. The transparent lower band makes the most of the light source, while the rest of the white glass body lets in a light that is perfect for relaxing environments.

Finitura vetro / Glass finish

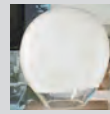

CR/BC

Nessa LT

NESSA LT

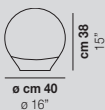

1x77W E27

CE ENEC

USA & CANADA

1x60W E26

SATA

design Favaretto&Partners 2017

Questo sistema di illuminazione prosegue la riflessione stilistica di Trepai, mettendo ancora più in risalto il legno, sulla cui struttura rigorosa e geometrica poggia il corpo illuminante in vetro soffiato. La collezione è declinata in più versioni per adattarsi a diversi contesti, sia classici sia moderni. Tonalità del vetro: ambra sfumato, bianco sfumato. Tonalità del legno: naturale, nero.

This lighting system carries on with the stylistic reflection of Trepai, and gives even more emphasis to wood, which forms the rigorous and geometric structure where the blown glass light source rests. The collection is available in several versions to suit different contexts, both classic and modern. Glass colour tone: shaded white, shaded amber. Wood colour tone: natural, black.

Finitura vetro / Glass finish



AM/SF



BC/SF

Finitura struttura / Frame finish

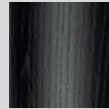

LFN

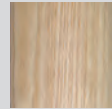

LFR

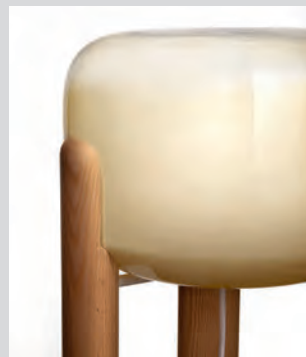

Sata LT

SATA LT

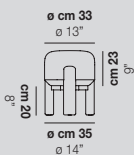

1x77W E27

CE ENEC

USA & CANADA

1x60W E26



GOOD
DESIGN
AWARD
2017

red dot
design
award
2017

Collezione / Collection



380



Vega LT

VEGA LT

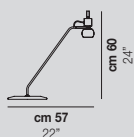

1x60W G9



USA & CANADA

1x60W G9



VEGA

design Michele De Lucchi 1982

La collezione Vega si distingue per le sue forme essenziali dal sapore vintage. Il vetro soffiato proposto in tre colori diversi ospita un nuovo attacco lampadina che consente l'utilizzo di sorgenti LED. Anche la parte superiore del diffusore che permette di orientare la lampada è in vetro soffiato incamiciato.

The Vega collection stands out for its essential shapes with a vintage mood. The blown glass, proposed in three different colours, has a new bulb socket fitting for LED sources. The upper part of the diffuser, which allows to orient the lamp, is in blown encased glass.

Finitura vetro / Glass finish

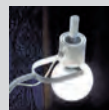

BC

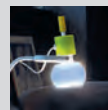

MC/1

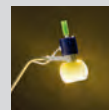

MC/2

Finitura struttura / Frame finish



BC



Collezione / Collection



304



387



Tread LT

TREAD

design Chiaramonte & Marin 2019

La "tecnicità" dell'elemento metallico unito al diffusore in vetro soffiato conferisce a Tread uno stile "industriale". Un oggetto che ricorda le apparecchiature elettriche vintage per la sua forma particolare, in cui il dissipatore alettato, unito al vetro soffiato, diviene elemento caratterizzante. Tread crea un'atmosfera all'avanguardia e di stile coniugando il vetro cristallo, fumé, terra bruciata e verde antico trasparente con finiture rame, oro e bronzo satinato.

The "technicity" of the metal element combined with the blown glass diffuser gives Tread an "industrial" style. An object reminiscent of vintage electrical equipment for its particular shape, in which the finned heat sink, combined with blown glass, becomes a distinctive element. Tread creates an avant-garde and stylish atmosphere by combining crystal, smoky, burned earth and transparent old green glass with copper, gold and bronze matt finishes.

Finitura vetro / Glass finish

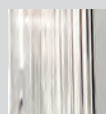

CR/TR



FU/TR

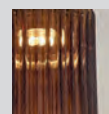

TB/TR

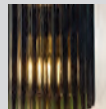

VA/TR

Finitura struttura / Frame finish

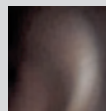

BHS

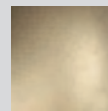

BKS

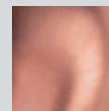

RAS

TREAD LT



1x60W E14



USA & CANADA

1x40W E12



Collezione / Collection



82



302

FUTURA

design Hangar Design Group 2015

Collezione di lampade costituite da un pezzo unico di vetro soffiato la cui particolare lavorazione però permette un doppio effetto cromatico: trasparente nella parte superiore, effetto satinato nella parte inferiore. Sono disponibili le seguenti possibilità di abbinamento vetro con anello metallico: vetro bianco con anello nero opaco, vetro fumé con anello marrone, vetro ambra con anello ottone. Nuova finitura vetro cristallo trasparente con possibilità di abbinare anello rame o nero opaco.

A collection of lamps made from a single piece of blown glass, whose particular workmanship, though, allows a double chromatic effect: transparent at the top, satin effect at the bottom. The following combinations of glass with metal ring are now available: white glass combined with matt black ring, smoky glass with brown ring, amber glass with painted brass ring. A new transparent crystal glass finish with copper or matt black ring is also available.

Finitura vetro / Glass finish



AM/OT



BC/NE



CR/NE



CR/RA

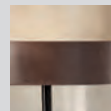

FU/MA

Finitura struttura / Frame finish

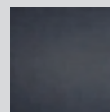

NE

Futura LT P / M

FUTURA LT P

FUTURA LT M



1x77W E27



USA & CANADA

1x60W E26

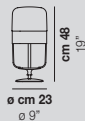

1x77W E27



USA & CANADA

1x60W E26



Collezione / Collection





Lucciola LT 30 P

LUCCIOLA LT 18*



1x48W E14



USA & CANADA

1x48W E12

LUCCIOLA LT 27*



1x48W E14



USA & CANADA

1x48W E12

LUCCIOLA LT P



1x77W E27



USA & CANADA

1x60W E26

Una delle più versatili collezioni. La sua forma ovale in vetro soffiato satinato è disponibile in diverse dimensioni, che si prestano a innumerevoli combinazioni d'installazione.

One of our most versatile collections. The oval and mouth-blown satin glass shape is available in different sizes, which can be combined to offer countless installation combinations.

Finitura vetro / Glass finish



BC/ST

LUCCIOLA LT M

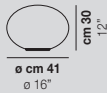

1x77W E27



USA & CANADA

1x60W E26

LUCCIOLA LT G

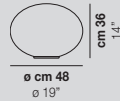

1x77W E27



USA & CANADA

1x60W E26

LUCCIOLA LT 30 P



1x77W E27



USA & CANADA

1x60W E26

Finitura struttura / Frame finish



BC

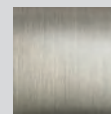

NI

* LT 18, LT 27 solo BC / LT 18, LT 27 only BC



Collezione / Collection



FEREA

design Babled & Co. 2009

Le linee uniche di Ferea sono rese possibili dall'impiego del taglio waterjet, che permette al designer di esplorare e plasmare forme inedite della tradizione del vetro muranese.

A unique design made possible by the use of the waterjet cutting, which allows the designer to explore and create shapes that give a new direction to the tradition of Murano glass.

Finitura vetro / Glass finish



BC/ST

Finitura struttura / Frame finish



BC

Ferea LT

FEREA LT



1x77W E27



USA & CANADA

1x60W E26



Bissona LT

BISSONA

design Vistosi 1968

Oggetto decorativo più che lampada da tavolo, riflette le linee semplici del design vintage nella qualità e unicità del suo vetro artigianale.

Bissona is a decorative object more than a table light. It reflects the simplicity of vintage design in the quality of glass and the uniqueness of its handmade production.

Finitura vetro / Glass finish



BC/LU

Finitura struttura / Frame finish



BC

BISSONA LT



1×60W G9



USA & CANADA

1×60W G9



Lio LT 40

LIO

design Vistosi 1972

Collezione dal design minimalista e discreto che esalta la sorgente luminosa, grazie alla fascia di vetro traslucida imprigionata tra gli strati del cristallo.

The minimal and unobtrusive design of this collection enhances the light source thanks to the translucent glass band trapped between the crystal layers.

Finitura vetro / Glass finish



CR/BC

Finitura struttura / Frame finish

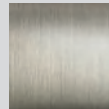

NI*

*Solo per LT P / Only for LT P

LIOLT P

LIOLT 40

LIOLT 50



1x60W G9
CE ENEC
USA & CANADA
 1x60W G9



1x77W E27
CE ENEC
USA & CANADA
 1x60W E26

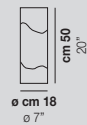

1x77W E27
CE ENEC
USA & CANADA
 1x60W E26

Collezione / Collection





Assiba LT

ASSIBA LT



1x77W E27



USA & CANADA

1x60W E26

ASSIBA

design Mauro Olivieri 2011

La collezione è composta da due cilindri in vetro disponibili color bianco o cristallo trasparente con lavorazione "balloton". I due elementi sono rotanti e possono essere orientati in direzioni diverse permettendo così composizioni sempre diverse e uniche.

The collection is composed of two glass cylinders available in white or transparent "balloton" crystal. The two elements are rotating and can be oriented in different directions, thus allowing always different and unique compositions.

Finitura vetro / Glass finish



BC/BT

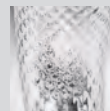

CR/BT



MC/2

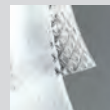

MC/3

Finitura struttura / Frame finish

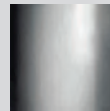

CR

Collezione / Collection



108



Munega LT P / G

MUNEGA

design Luciano Vistosi 1978

Collezione di lampade in vetro soffiato e modellato a mano libera per creare una forma iconica.

Collection of lamps made of blown and hand-shaped glass to create an iconic form.

Finitura vetro / Glass finish



BC

MUNEGA LT P

MUNEGA LT G



1x60W E14

CE ENEC

USA & CANADA

1x40W E12



1x77W E27

CE ENEC

USA & CANADA

1x60W E26



Puppet LT P

PUPPET

design Romani Sacconi Architetti 2015

Collezione di lampade in vetro soffiato e rigato irregolarmente. Le sfere di tre dimensioni differenti e le diverse altezze dei cavi sono studiate per creare eleganti composizioni. La versione chandelier permette di fissare a piacere a soffitto i diffusori con cavetti d'acciaio creando giochi sempre diversi.

Collection of lamps with a blown and irregular striped glass diffuser. The three sizes of the spheres and the different cable heights are designed to create elegant compositions. The chandelier version allows to fix the diffusers with steel cables to the ceiling, creating different games.

Finitura vetro / Glass finish

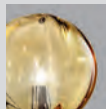

AM/TR

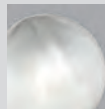

BC/SF

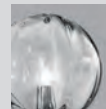

CR/TR

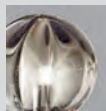

FU/TR

Finitura struttura / Frame finish



CR

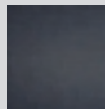

NE

PUPPET LT P

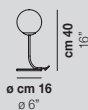

1x60W G9

CE ENEC

USA & CANADA

1x60W G9

Collezione / Collection



32



316

NAXOS

archivio storico Vetreria Vistosi 1988



Naxos LT 50

NAXOS LT MN



1x60W E14
CE ENEC

USA & CANADA

1x40W E12

NAXOS LT 33



1x60W E14 + 1x40W E14
CE ENEC

USA & CANADA

1x40W E12 + 1x25W E12

NAXOS LT 50

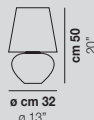

1x77W E27 + 1x40W E14
CE ENEC

USA & CANADA

1x60W E26 + 1x40W E12

Collezione di lampade dal design senza tempo, che esalta la qualità del vetro satinato. La versione da tavolo sfrutta il vantaggio di due sorgenti luminose: la base e il paralume.

A collection of lamps with a timeless design that maximizes the quality of the satin-finished glass. The table versions have a double light source: the shade and the base.

Finitura vetro / Glass finish

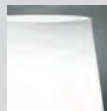

BC/ST

Finitura struttura / Frame finish



BC

NAXOS LT 76

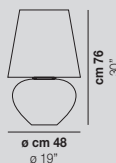

1x77W E27 + 3x40W E14
+ 1x46W E27

CE ENEC

USA & CANADA

1x60W E26 + 3x40W E12
+ 1x43W E26



Collezione / Collection



148



385

BOLLE

design Barbara Maggiolo 2003

La caratteristica texture di questa collezione viene dalla tecnica "balloton", che consiste nell'inserimento di bolle d'aria nel vetro durante la lavorazione. L'effetto "tessuto" che si ottiene moltiplica i riflessi sulla superficie della sfera.

The main characteristic of this collection of lamps produced with the "balloton" technique is the insertion of bubbles of air in the glass during its production. That creates multiple reflections and adds an organic texture on the surface of the sphere.

Finitura vetro / Glass finish



BC/BO

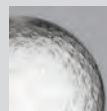

CR/BO

Finitura struttura / Frame finish

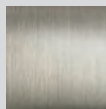

NI

BOLLE LT P



 16 cm

 6"

1x60W G9

CE ENEC PS

USA & CANADA

1x60W G9



Collezione / Collection

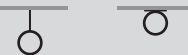

118

244



Damasco LT P / M / G

DAMASCO

design Paolo Crepax 2003

Collezione realizzata con la tecnica a bozzolo, in cui l'originale decoro diventa un vero e proprio materiale: la sovrapposizione di fili di vetro fuso a creare una texture in rilievo. Damasco è una delle creazioni di più lungo successo, che vede nel tempo versioni sempre nuove.

The collection is produced with the bozzolo technique: that consists in applying threads of molten glass to create an organic texture. Damasco is one of our most successful series, which has been developed and extended during the years with new versions.

Finitura vetro / Glass finish

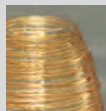

CR/AM



CR/CR

Finitura struttura / Frame finish

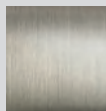

NI



DAMASCO LT P

DAMASCO LT M

DAMASCO LT G



1x60W G9
CE ENEC CB EAC
 USA & CANADA
 1x60W G9



1x77W E27
CE ENEC CB EAC
 USA & CANADA
 1x60W E26



1x77W E27
CE ENEC CB EAC
 USA & CANADA
 1x60W E26

Collezione / Collection

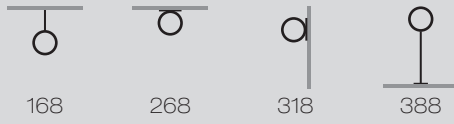



Novecento LT

NOVECENTO

design Romani Sacconi Architetti 2015

La forma di questa collezione nasce dalla volontà di reinterpretare il tradizionale lampadario muranese. Finitura del vetro cristallo o bianco rigadin è stata il tocco da maestro: le sue rigature radiali evocano l'andamento dei bracci dello storico candeliere mantenendo un sapore contemporaneo.

The shape of this collection stems from the desire to reinterpret the traditional Murano chandelier. The choice of the crystal or white rigadin glass finish was the master's touch: its radial stripes evoke the arms of the historic candlestick while maintaining a contemporary flavour.

Finitura vetro / Glass finish



BC/RI



CR/RI

Finitura struttura / Frame finish



CR

NOVECENTO LT

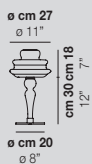

1x60W E14

CE ENEC

USA & CANADA

1x40W E12



Collezione / Collection



94



240



386

Diadema LT B G



DIADEMA

design Romani Sacconi Architetti 2005

Luce in movimento. È la sensazione che invade l'ambiente quando si accende una Diadema. Il lavoro di Romani Sacconi Architetti Associati, padri di questo progetto, si concentra dapprima sul singolo elemento della canna di vetro in cristallo per poi svilupparsi su un sistema composto: combinando canne di diverse dimensioni, la luce si riflette e trasmette la dinamicità desiderata. Numerose le varianti e le possibilità di personalizzazione. Tonalità del vetro in cristallo. Parti metalliche in finitura bronzo satinato e cromo.

Light in motion. That is the sensation pervading the environment when a Diadema is switched on. The work of Romani Sacconi Architetti Associati, the fathers of this project, first concentrates on the single element of the glass rod and then develops on a composite system: by combining rods of different sizes, the light is reflected and conveys the desired dynamism. Several variants and possibilities for customization are available. Crystal glass shade. Metal parts finishing in satin bronze and chrome.

Finitura vetro / Glass finish



CR

Finitura struttura / Frame finish



BS

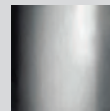

CR

DIADEMA LT A P

DIADEMA LT B G

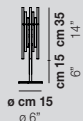

1×60W G9
CE ENEC
USA & CANADA
 1×60W G9

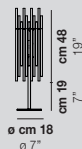

1×60W G9
CE ENEC
USA & CANADA
 1×60W G9



Collezione / Collection





Minigiogali LT

MINIGIOGALI LT

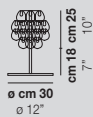

1x77W E27

CE ENEC (C) (P)

USA & CANADA (UL)

1x60W E26

MINIGIOGALI

design Angelo Mangiarotti 1967

La versione ridotta di Giogali, che permette di impiegare i ganci in cristallo per installazioni a parete di minori dimensioni, standard o su misura.

The small size version of Giogali, which allows the use of glass hooks for smaller, standard or custom-made wall installations.

Finitura vetro / Glass finish

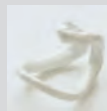

BC



CR/AG

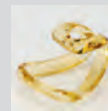

CR/AM



CR/BR



CR/FU



CR/NN

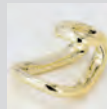

CR/OR



CR/RA



CR/TR



NE

Finitura struttura / Frame finish

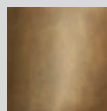

BR



CR

Collezione / Collection



218



282



330



393



Spirit LT 37

SPIRIT

design Marco Acerbis 2013

Spirit ha la forma del diamante soffiata nel vetro. Le particolari rigature, frutto di una lunga ricerca, catturano la luce e la riflettono, nascondendo la sorgente luminosa anche nella versione in cristallo trasparente.

Spirit has the shape of a diamond blown into glass. Its folds are the result of a long process of development that creates a unique light reflection, while keeping the source of light hidden even in the transparent crystal version.

Finitura vetro / Glass finish



BC/LU

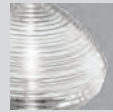

CR/TR

Finitura struttura / Frame finish

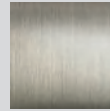

NI

SPIRIT LT 37

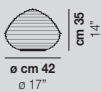

1x77W E27



USA & CANADA

1x60W E26

Collezione / Collection

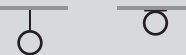

86

254

Terra / Floor

Sospensioni / <i>Suspensions</i>	29
Plafoniere / <i>Ceiling</i>	225
Parete / <i>Wall</i>	287
Tavolo / <i>Table</i>	335

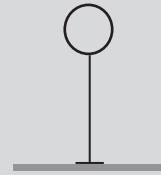

Terra / Floor



Damasco
388

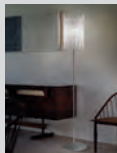

Diadema
391

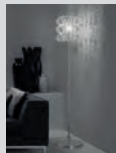

Ecos
390

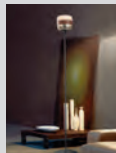

Futura
383



Giogali
392

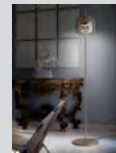

Jube
376

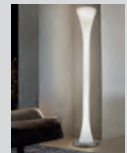

Lepanto
382



Lucciola
384



Minigiogali
393



Naxos
385

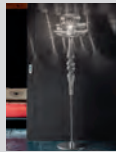

Novecento
386

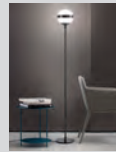

Peggy
378

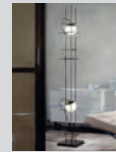

Plot Frame
374

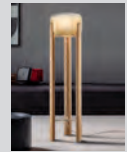

Sata
380



Trepai
381



Vega
387

PLOT FRAME

design Chiaramonte & Marin 2019



Plot Frame PT 2

PLOT FRAME PT 2

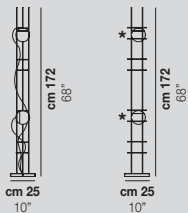

2x11,5W 3200 lm **LED 09**



USA & CANADA

2x8,5W 2500 lm **LED 09**

** Elementi luminosi in vetro installabili in diverse posizioni a scelta del Cliente.

The luminous glass elements that can be installed in different positions on Customer choice.

L'ispirazione dalla quale nasce la linea Plot frame è la semplicità della sfera e il tentativo di rappresentarne il movimento. Una trama metallica all'interno della quale sfere di vetro luminescenti sono quasi libere di muoversi consentendo al fruitore di interagire con l'oggetto. Montatura nera opaca. Sorgente luminosa LED.

The inspiration behind Plot Frame is to render the motion and simplicity of a sphere. A metal weave where luminescent glass spheres are almost free to move, allowing the user to interact with the object. Matt black frame. LED light source.

Finitura vetro / Glass finish

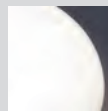

BC/LU

Finitura struttura / Frame finish

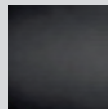

NEO

LED Europe/International **CE ENEC**

09 11,5W - 25V - 1600lm - 2700K/3000K - DIM4

LED Usa & Canada

09 8,5W - 25V - 1250 lm - 2700K/3000K - DIM4

Collezione / Collection



68

292

JUBE

design Favaretto&Partners 2017



Jube PT P

376

JUBE PT P

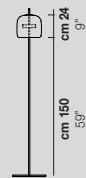

ø cm 35
ø 14"

1x13W LED 15

CE ENEC

USA & CANADA

1x13W LED 15

L'aspetto elegante e delicato del vetro soffiato trova in Jube una nuova dimensione. Due vetri accostati, perfettamente assemblati, da sembrare un pezzo unico. Una lampada sinuosa, con colori tono su tono che le regalano un prezioso mood vintage.

The elegant and delicate look of the blown glass finds a new dimension in Jube. Two glass units placed side by side, so perfectly assembled, that they look like a unique piece. A sinuous lamp, with tone-on-tone colours that give it a precious, vintage mood.

Finitura vetro / Glass finish



AA/TR



CR/TR



FU/TR

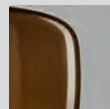

TB/TR

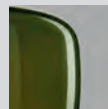

VA/TR

Finitura struttura / Frame finish



AVS

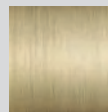

OS

LED Europe/International CE ENEC

15 13W - 37V - 2000lm - 2700K/3000K - DIM4

LED Usa & Canada

15 13W - 37V - 2000lm - 2700K/3000K - DIM4



archiproducts
DESIGN AWARDS
WINNER 2020

JUBE 2020

Collezione / Collection



76



298



342

PEGGY

design Hangar Design Group 2014



Peggy PT

PEGGY PT



1×60W E14



USA & CANADA

1×40W E12

Il bianco e il nero. Da questa polarità cromatica e materica nasce Peggy. Il progetto illuminotecnico concilia la leggerezza del vetro soffiato bianco lucido, lavorato interamente a mano, con il carattere più vivace del metallo lucido nero o dell'ottone anticato. Il connubio di grande effetto comunica razionalità e eleganza al tempo stesso.

White and black. Peggy was created starting from this chromatic and material polarity. This lighting design combines the lightness of glossy white blown glass, entirely handmade, with the liveliest character of the glossy metal black or antique brass. This effective combination conveys rationality and elegance at the same time.

Finitura vetro / Glass finish

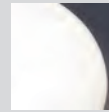

BC/LU

Finitura struttura / Frame finish

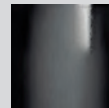

NEL



OT

Collezione / Collection



56



290



SATA

design Favaretto&Partners 2017

Questo sistema di illuminazione prosegue la riflessione stilistica di Trepai, mettendo ancora più in risalto il legno, sulla cui struttura rigorosa e geometrica poggia il corpo illuminante in vetro soffiato. La collezione è declinata in più versioni per adattarsi a diversi contesti, sia classici sia moderni. Tonalità del vetro: ambra sfumato, bianco sfumato. Tonalità del legno: naturale, nero.

This lighting system carries on with the stylistic reflection of Trepai, and gives even more emphasis to wood, which forms the rigorous and geometric structure where the blown glass light source rests. The collection is available in several versions to suit different contexts, both classic and modern. Glass colour tone: shaded white, shaded amber. Wood colour tone: natural, black.

Finitura vetro / Glass finish



AM/SF

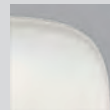

BC/SF

Finitura struttura / Frame finish

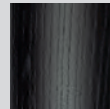

LFN

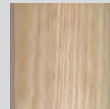

LFR

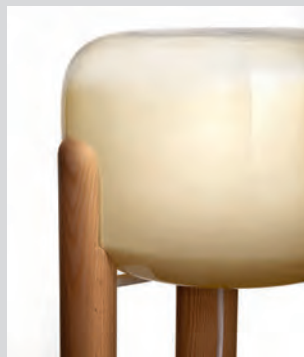

SATA PT

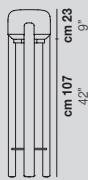

ø cm 35
ø 14"

1x77W E27

CE ENEC

USA & CANADA

1x60W E26



GOOD
DESIGN
AWARD
2017

red dot
design
award
2017

Collezione / Collection



350

TREPAI

design Favaretto&Partners 2013

La versatilità è la chiave di questa collezione di lampade: Trepai è perfetta in contesti sia classici che moderni, grazie al supporto in legno di noce nella versione da terra. All'origine dialettale veneziana del nome si unisce l'eco della fonetica giapponese, che richiama la severità e semplicità della cultura nipponica.

The main characteristic of this collection is the versatility: it fits in any classic or modern interior, thanks to the use of a stand made with walnut wood. Its means from 'three sticks' in Venetian dialect and also echoes Japanese phonetics, conveying both the simplicity and severity of that culture.

Finitura vetro / Glass finish



BC



FU/DI

Finitura struttura / Frame finish

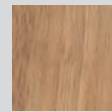

LNO



Trepai PT

TREPAI PT

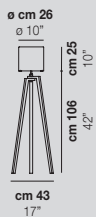

1x77W E27

CE EAC

USA & CANADA

1x60W E26



grandesignEtico



Lepanto PT

LEPANTO

design Luciano Vistosi 1968

Lepanto è una vera scultura in vetro di Murano, che richiede grande abilità tecnica nella realizzazione. La finitura del vetro "pulegoso" che la caratterizza, trasforma la superficie in una raffinata texture naturale.

A light sculpture of classical inspiration made in Murano glass requiring a high degree of technical skill. The "pulegoso" finish adds a unique organic texture to the surface of the glass.

Finitura vetro / Glass finish



BC/PU

Finitura struttura / Frame finish

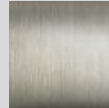

NI

LEPANTO PT

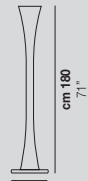

ø cm 34
ø 13"

1×18W G5 LED + 1×77W E27

CE ENEC

USA & CANADA

1×18W G5 LED + 1×60W E26



Collezione / Collection



186

FUTURA

design Hangar Design Group 2015

Collezione di lampade costituite da un pezzo unico di vetro soffiato la cui particolare lavorazione però permette un doppio effetto cromatico: trasparente nella parte superiore, effetto satinato nella parte inferiore. Sono disponibili le seguenti possibilità di abbinamento vetro con anello metallico: vetro bianco con anello nero opaco, vetro fumé con anello marrone, vetro ambra con anello ottone. Nuova finitura vetro cristallo trasparente con possibilità di abbinare anello rame o nero opaco.

A collection of lamps made from a single piece of blown glass, whose particular workmanship, though, allows a double chromatic effect: transparent at the top, satin effect at the bottom. The following combinations of glass with metal ring are now available: white glass combined with matt black ring, smoky glass with brown ring, amber glass with painted brass ring. A new transparent crystal glass finish with copper or matt black ring is also available.

Finitura vetro / Glass finish



AM/OT



BC/NE



CR/NE



CR/RA

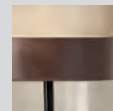

FU/MA

Finitura struttura / Frame finish

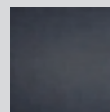

NE

Futura PT P

FUTURA PT P



1x77W E27



USA & CANADA

1x60W E26



Collezione / Collection

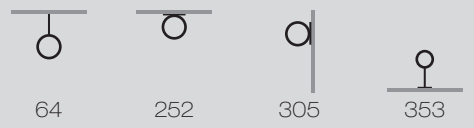

LUCCIOLA

design Vistosi 1981

Una delle più versatili collezioni. La sua forma ovale in vetro soffiato satinato è disponibile in diverse dimensioni, che si prestano a innumerevoli combinazioni d'installazione.

One of our most versatile collections. The oval and mouth-blown satin glass shape is available in different sizes, which can be combined to offer countless installation combinations.

Finitura vetro / Glass finish



BC/ST

Finitura struttura / Frame finish



BC

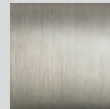

NI

Lucciola PT M



LUCCIOLA PT P

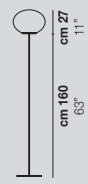

ø cm 28
ø 11"

1x77W E27

CE ENEC

USA & CANADA

1x60W E26

LUCCIOLA PT M



ø cm 28
ø 11"

1x77W E27

CE ENEC

USA & CANADA

1x60W E26

Collezione / Collection





Naxos PT 50

NAXOS PT 50



3x77W E27



USA & CANADA

3x60W E26

NAXOS

design Vistosi 1988

Collezione di lampade dal design senza tempo, che esalta la qualità del vetro satinato. La versione da tavolo sfrutta il vantaggio di due sorgenti luminose: la base e il paralume.

A collection of lamps with a timeless design that maximizes the quality of the satin-finished glass. The table versions have a double light source: the shade and the base.

Finitura vetro / Glass finish

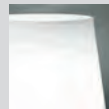

BC/ST

Finitura struttura / Frame finish

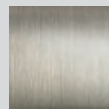

NI

Collezione / Collection

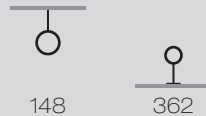



Novecento PT

NOVECENTO

design Romani Sacconi Architetti 2013

La forma di questa collezione nasce dalla volontà di reinterpretare il tradizionale lampadario muranese. Finitura del vetro cristallo o bianco rigadin è stata il tocco da maestro: le sue rigature radiali evocano l'andamento dei bracci dello storico candeliere mantenendo un sapore contemporaneo.

The shape of this collection stems from the desire to reinterpret the traditional Murano chandelier. The choice of the crystal or white rigadin glass finish was the master's touch: its radial stripes evoke the arms of the historic candlestick while maintaining a contemporary flavour.

Finitura vetro / Glass finish



BC/RI



CR/RI

Finitura struttura / Frame finish



CR

NOVECENTO PT

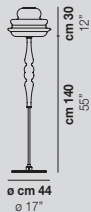

1x77W E27

CE ENEC

USA & CANADA

1x60W E26



Collezione / Collection



94



240



366



Vega PT

VEGA

design Michele De Lucchi 1982

La collezione Vega si distingue per le sue forme essenziali dal sapore vintage. Il vetro soffiato proposto in tre colori diversi ospita un nuovo attacco lampadina che consente l'utilizzo di sorgenti led. Anche la parte superiore del diffusore che permette di orientare la lampada è in vetro soffiato incamiciato.

The Vega collection stands out for its essential shapes with a vintage mood. The blown glass, proposed in three different colours, has a new bulb socket fitting for LED sources. The upper part of the diffuser, which allows to orient the lamp, is in blown encased glass.

Finitura vetro / Glass finish



BC



MC/1

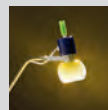

MC/2

Finitura struttura / Frame finish



BC



VEGA PT



1x60W G9

CE ENEC

USA & CANADA

1x60W G9



Collezione / Collection



304



351

DAMASCO
design Paolo Crepax 2003



Damasco PT G

DAMASCO PT 100 P

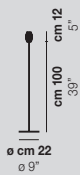

1x60W G9
CE ENEC
USA & CANADA
 1x60W G9

DAMASCO PT 140 P

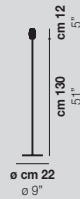

1x60W G9
CE ENEC
USA & CANADA
 1x60W G9

DAMASCO PT 180 P

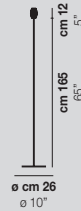

1x60W G9
CE ENEC
USA & CANADA
 1x60W G9

Collezione realizzata con la tecnica a "bozzolo", in cui l'originale decoro diventa un vero e proprio materiale: la sovrapposizione di fili di vetro fuso a creare una texture in rilievo. Damasco è una delle creazioni di più lungo successo, che vede nel tempo versioni sempre nuove.

The collection is produced with the bozzolo technique: that consists in applying threads of molten glass to create an organic texture. Damasco is one of our most successful series, which has been developed and extended during the years with new versions.

DAMASCO PT M



1x77W E27
CE **CB ENEC**
USA & CANADA
 1x60W E26

DAMASCO PT G

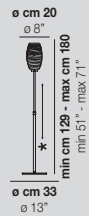

1x77W E27
CE **CB ENEC**
USA & CANADA
 1x60W E26

Finitura vetro / Glass finish

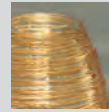

CR/AM



CR/CR

Finitura struttura / Frame finish

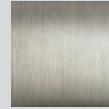

NI

* Lo stelo è regolabile in altezza / *The height of the base may be adjusted*



Collezione / Collection



168



268



318



365



ECOS PT 35

ECOS

design Renato Toso, Noti Massari 2007

Un anello, infinite combinazioni. La matrice da cui nasce l'idea della collezione Ecos è una sola: l'anello di vetro. Le declinazioni cromatiche e di texture che i designer Renato Toso, Noti Massari e Associati hanno saputo ricavare da questo semplice elemento sono davvero molte. Questo rende la collezione estremamente personalizzabile in termini di forme e misure, per un'illuminazione davvero originale. Tonalità del vetro bianco o cristallo con lavorazione rigadin. Parti metalliche in finitura bronzo satinato e cromo.

One ring, infinite combinations. The concept of the Ecos collection is just in one element: the glass ring. The chromatic and texture variations that the designers Renato Toso, Noti Massari e Associati have been able to obtain from this simple element are several. That makes the collection extremely customizable in terms of shapes and sizes, for a truly original lighting. Rigadin white or crystal colour glass. Metal parts finishing in satin bronze and chrome.

Finitura vetro / Glass finish



BC/RI

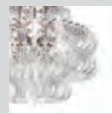

CR/RI

Finitura struttura / Frame finish



BS

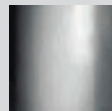

CR

ECOS PT 35



1x77W E27

CE ENEC CCC PS

USA & CANADA

1x60W E26



Collezione / Collection



204



276



328

DIADEMA

design Romani Saccani Architetti 2005

Luce in movimento. È la sensazione che invade l'ambiente quando si accende una Diadema. Il lavoro di Romani Saccani Architetti Associati, padri di questo progetto, si concentra dapprima sul singolo elemento della canna di vetro in cristallo per poi svilupparsi su un sistema composto: combinando canne di diverse dimensioni, la luce si riflette e trasmette la dinamicità desiderata. Numerose le varianti e le possibilità di personalizzazione. Tonalità del vetro in cristallo. Parti metalliche in finitura bronzo satinato e cromo.

Light in motion. That is the sensation pervading the environment when a Diadema is switched on. The work of Romani Saccani Architetti Associati, the fathers of this project, first concentrates on the single element of the glass rod and then develops on a composite system: by combining rods of different sizes, the light is reflected and conveys the desired dynamism. Several variants and possibilities for customization are available. Crystal glass shade. Metal parts finishing in satin bronze and chrome.

Finitura vetro / Glass finish



CR

Finitura struttura / Frame finish



BS

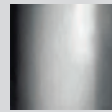

CR

Diadema PT B G

DIADEMA PT C M

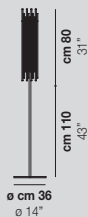

3×60W G9

CE ENEC (CCC) (PSE)

USA & CANADA

3×60W G9

DIADEMA PT B G



3×60W G9

CE ENEC (CCC) (PSE)

USA & CANADA

3×60W G9



Collezione / Collection

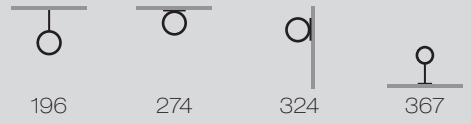



Giogali PT

GIOGALI PT

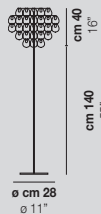

3x77W E27

CE ENEC (CCC) (PS)

USA & CANADA (UL)

3x60W E26



GIOGALI

design Angelo Mangiarotti 1967

Un elemento, puro: il gancio di cristallo. È l'intuizione di un Maestro del design italiano come Angelo Mangiarotti che, nel 1967, dà origine al best seller del catalogo Vistosi, Giogali. Un intreccio iconico applicato alla versione che si preferisce.

A pure element: the crystal hook. It is the intuition of a master of Italian design, Angelo Mangiarotti, who in 1967 created the best seller of the Vistosi catalogue, Giogali. An iconic interweaving applied to the version one prefers.

Finitura vetro / Glass finish



BC



CR/AG



CR/AM



CR/BR



CR/FU



CR/NN



CR/OR

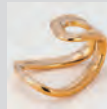

CR/RA



CR/TR



NE

Finitura struttura / Frame finish

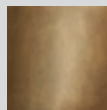

BR

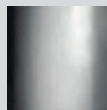

CR

Collezione / Collection



210



278



332



Minigiogali PT

MINIGIOGALI PT



3x77W E27

CE ENEC

USA & CANADA

3x60W E26



MINIGIOGALI

design Angelo Mangiarotti 1967

La versione ridotta di Giogali, che permette di impiegare i ganci in cristallo per installazioni a parete di minori dimensioni, standard o su misura.

The small size version of Giogali, which allows the use of glass hooks for smaller, standard or custom-made wall installations.

Finitura vetro / Glass finish



BC



CR/AG

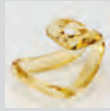

CR/AM



CR/BR



CR/FU



CR/NN

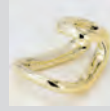

CR/OR



CR/RA



CR/TR



NE

Finitura struttura / Frame finish

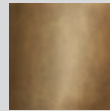

BR



CR

Collezione / Collection



218



282



330



368

Contenuti / Contents

Vistosi

Indice / <i>Index</i>	4
Indice fotografico / <i>Photographic index</i>	6
Storia / <i>History</i>	8
I nostri numeri / <i>Our numbers</i>	18
Azienda / <i>Company</i>	19
Designer / <i>Designers</i>	20
Progetti / <i>Projects</i>	22

Prodotti / Products

Sospensioni / <i>Suspensions</i>	29
Plafoniere / <i>Ceiling</i>	225
Parete / <i>Wall</i>	287
Tavolo / <i>Table</i>	335
Terra / <i>Floor</i>	371

Informazioni / Information

Come leggere il catalogo / <i>How to read the catalog</i>	396
Legenda / <i>Keys</i>	397

Materiali / Materials

Colori del vetro / <i>Glass colours</i>	398
Finiture del vetro / <i>Glass finishes</i>	398
Finiture delle parti metalliche / <i>Metal parts finishes</i>	399
Altre finiture / <i>Other finishes</i>	399

Decentramenti / Swag systems	400
-------------------------------------	------------

Nuove caratteristiche LED 2021 / New LED features 2021	401
---	------------

Informazioni / Information

Come leggere il catalogo / How to read the catalog

BOLLE SP P
 max cm 200
 max 7/9"
 max 15"
 max 6"
 1x60W G9 / LED B
 1x60W G9 / LED B
 CE CB IRI
 USA & CANADA

BOLLE SP G
 max cm 200
 max 7/9"
 max 15"
 max 6"
 1x77W E27 / LED C
 1x60W E26 / LED C
 CE CB IRI
 USA & CANADA

BOLLE SP 35
 max cm 200
 max 7/9"
 max 15"
 max 6"
 1x77W E27 / LED C
 1x60W E26 / LED C
 CE CB IRI
 USA & CANADA

La caratteristica texture di questa collezione viene dalla tecnica "balloon", che consiste nell'inserimento di bolle d'aria nel vetro durante la lavorazione. L'effetto "bessuto" che si ottiene moltiplica i riflessi sulla superficie della sfera.

The main characteristic of this collection of lamps produced with the "balloon" technique is the insertion of bubbles of air in the glass during its production, that create multiple reflections and add an organic texture on the surface of the sphere.

Finitura vetro / Glass finish
 BO/BO CR/BO

Finitura struttura / Frame finish
 N

LED Europe/International
 B 9W-34V-1100lm/1200lm-2700K/3000K-DIM2/DIM3
 C 12W-35V-1500lm/1600lm-2700K/3000K-DIM2/DIM3

LED Usa & Canada
 B 9W-34V-1100lm/1200lm-2700K/3000K-DIM2/DIM3
 C 12W-35V-1500lm/1600lm-2700K/3000K-DIM2/DIM3

Collezione / Collection
 244 364

descrizione famiglia / category description

finitura vetro / glass finish

finitura montatura / finishes of metal parts

versione LED Europa / European LED versions

opzioni temperatura colore e dimmerazione
 colour temperature and dimming options

versione LED USA & Canada / USA & Canada LED version

tipologie alternative / alternative types

BOLLE SP P

max cm 200
 max 7/9"
 cm 15
 0
 o cm 16
 ø 6"

1x60W G9 / LED B
 CE CB IRI
 USA & CANADA
 1x60W G9 / LED B

LED

certificati versione alogena per Europe/International
 halogen version certificates for Europe/International

certificati versione alogena per USA&CANADA
 halogen version certificates for USA&CANADA

LED

codice prodotto / product code

dimensioni / dimensions

lampadine / bulbs

lampadine / bulbs

Legenda / Keys

Tipologia / Type

SP	Sospensione	<i>Suspension</i>
PL	Plafoniera	<i>Ceiling</i>
AP	Parete	<i>Wall</i>
PP	Parete - Soffitto	<i>Wall - Ceiling</i>
FA	Faretto	<i>Spotlight</i>
LT	Tavolo	<i>Table</i>
PT	Terra	<i>Floor</i>

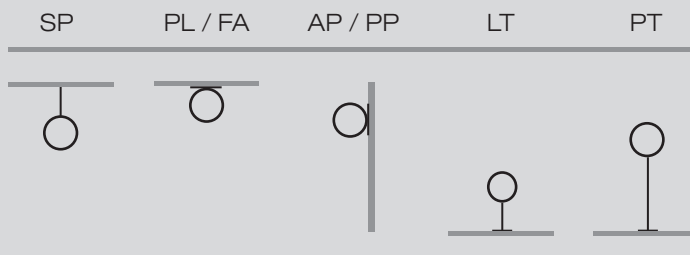

Certificazioni di prodotto / *Product certifications*



Certificato di "Conformità Europea", indica che il prodotto è conforme alle norme di sicurezza Europee

"European Conformity" marking, which indicates that the product complies with the European safety standards.



È il massimo delle certificazioni di prodotto vigenti in Europa. Per ottenere questo certificato, il prodotto deve superare i test di sicurezza Europei, ma anche i test specifici richiesti da tutti gli stati membri.

It is the high quality European certification for products. In order to obtain it, the product must pass the European security tests as well as the specific tests required by each Member State.



Certificato di conformità del prodotto alle normative di sicurezza elettro-technica della Federazione Russa.

Certification indicating products that conform to the electro-technical safety regulations of the Russian Federation.



Certificato di conformità del prodotto alle normative di sicurezza elettro-technica della Cina.

Certification indicating products that conform to the electro-technical safety regulations of China.



Certificato di conformità del prodotto alle normative di sicurezza elettro-technica del Giappone. Disponibile solo su richiesta e fornito da Doi&Co. Luminabella Div.

Certification indicating products that conform to Japan's electro-technical safety regulations. Available only on request and supplied by Doi & Co. Luminabella Div.



Certificato internazionale di sicurezza elettro-technica di prodotto, riconosciuto da oltre 50 Paesi.

International Certification of electro-technical product safety, recognized by over 50 countries.



Certificato di conformità del prodotto alle normative di sicurezza elettro-technica degli Stati Uniti e del Canada. Disponibile per i mercati di riferimento.

Certification of product conformity to the electro-technical safety regulations of the United States and Canada. Available for the specific markets.



Simbolo che indica che l'apparecchio è conforme alle linee guida dell'Americans with Disabilities Act (ADA).

Symbol indicating that the device complies with the guidelines of the Americans with Disabilities Act (ADA).

Materiali / Materials

Colori del vetro / Glass colours

AA	ametista chiara	<i>light amethyst</i>
AD	ambra scura	<i>dark amber</i>
AM	ambra	<i>amber</i>
AT	ametista	<i>amethyst</i>
BC	bianco	<i>white</i>
CR	crystallo	<i>crystal</i>
FU	fumè	<i>smoky</i>
GR	grigio	<i>grey</i>
NE	nero	<i>black</i>
SB	sabbia	<i>sand</i>
SE	seta	<i>silk</i>
TB	terra bruciata	<i>burned earth</i>
VA	verde antico	<i>old green</i>

Finiture del vetro / Glass finishes

.. / AG	.. / argento	.. / <i>silver</i>
.. / BC	.. / bianco	.. / <i>white</i>
.. / BO	.. / "bolle"	.. / <i>"bubbles"</i>
.. / BR	.. / bronzo	.. / <i>bronze</i>
.. / BT	.. / "balloton"	.. / <i>"balloton"</i>
.. / CM	.. / metallizzato	.. / <i>metallized</i>
.. / DI	.. / diffusore lucido	.. / <i>glossy diffuser</i>
.. / FO	.. / foglia oro	.. / <i>gold leaf</i>
.. / LU	.. / lucido	.. / <i>glossy</i>
.. / MF	.. / metallizzato sfumato	.. / <i>shaded metallized</i>
.. / MU	.. / "murrina"	.. / <i>"murrina"</i>
.. / NE	.. / nero	.. / <i>black</i>
.. / OR	.. / oro	.. / <i>gold</i>
.. / PU	.. / "pulegoso"	.. / <i>"pulegoso"</i>
.. / RA	.. / rame	.. / <i>copper</i>
.. / RI	.. / rigadin	.. / <i>striped glass</i>
.. / RV	.. / rigadin verticale	.. / <i>striped vertical glass</i>
.. / SF	.. / sfumato	.. / <i>shaded</i>
.. / ST	.. / satinato	.. / <i>matt</i>
.. / TR	.. / trasparente	.. / <i>transparent</i>

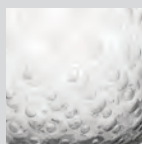

.. / **BO**

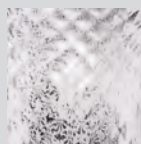

.. / **BT**

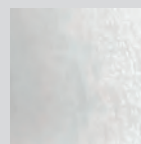

.. / **PU**

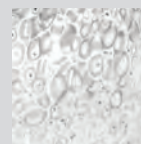

.. / **MU**

Finiture delle parti metalliche / *Metal parts finishes*

AB	alluminio bronzo	<i>bronze aluminium</i>	NN	nickel nero	<i>black nickel</i>
AS	acciaio specchiato	<i>mirrored steel</i>	NNS	nickel nero satinato	<i>matt black nickel</i>
AVS	acciaio satinato	<i>matt steel</i>	NO	nickel opaco	<i>matt nickel</i>
BC	bianco lucido	<i>glossy white</i>	N_O*	nero - ottone	<i>black - brass</i>
BD	bianco opaco 2	<i>matt white 2</i>	N_R*	nero - rame	<i>black - copper</i>
BH	bronzo lucido 2	<i>glossy bronze 2</i>	OA	oro rosa satinato	<i>matt pink gold</i>
BHS	bronzo satinato 3	<i>matt bronze 3</i>	OG	ottone lucido 2	<i>glossy brass 2</i>
BKL	ottone lucido	<i>glossy brass 1</i>	OP	oro satinato 1	<i>matt gold 1</i>
BKS	oro satinato 3	<i>matt gold 3</i>	OR	oro lucido	<i>glossy gold</i>
BO	bianco opaco 1	<i>matt white 1</i>	OS	oro satinato 2	<i>matt gold 2</i>
BP	bianco opaco 3	<i>matt white 3</i>	OT	ottone anticato	<i>antique brass</i>
BR	bronzo opaco 1	<i>matt bronze 1</i>	OTL	ottone	<i>brass</i>
BS	bronzo satinato 2	<i>matt bronze 2</i>	OTS	ottone satinato	<i>matt brass</i>
BV	bronzo lucido 1	<i>glossy bronze 1</i>	RA	rame lucido	<i>glossy copper</i>
CR	cromo lucido	<i>glossy chrome</i>	RAS	rame satinato 1	<i>matt copper 1</i>
GR	grigio	<i>grey</i>	RAV	rame satinato 2	<i>matt copper 2</i>
MA	marrone	<i>brown</i>	R_N	rame lucido - nero opaco	<i>glossy copper - matt black</i>
NE	nero opaco 1	<i>matt black 1</i>	N_O*		
NEL	nero lucido	<i>glossy black</i>		N = NNS (external finish)	
NEO	nero opaco 2	<i>matt black 2</i>		O = BKS (internal finish)	
NI	nickel satinato	<i>satin nickel</i>	N_R*		
NIB	nickel - bianco	<i>nickel - white</i>		N = NNS (external finish)	
NL	nickel lucido	<i>glossy nickel</i>		R = RAV (internal finish)	

Altre finiture / *Other finishes*

LFN	legno frassino nero	<i>black ash wood</i>
LFR	legno frassino naturale	<i>natural ash wood</i>
LNO	legno noce naturale	<i>natural walnut wood</i>

Legenda codici prodotto / *Keys of product codes*

es. ex.	codice prodotto <i>product code</i>	tipologia <i>type</i>	modello <i>model</i>	colore vetro <i>glass colour</i>	finitura vetro <i>glass finish</i>	finitura struttura <i>metal part finish</i>	sorgente <i>lamping</i>
1	ASSIBA SP G BC/BT CR E27	sospensione <i>suspension</i>	grande <i>large</i>	bianco <i>white</i>	/ balloton <i>balloton</i>	cromo <i>chrome</i>	E27
2	ASSIBA SP 2 CR/BT CR LED	sospensione <i>suspension</i>	2 vetri <i>2 glasses</i>	cristallo <i>crystal</i>	/ balloton <i>balloton</i>	cromo <i>chrome</i>	LED

Decentramenti / Swag systems

Versioni precedenti / Previous versions

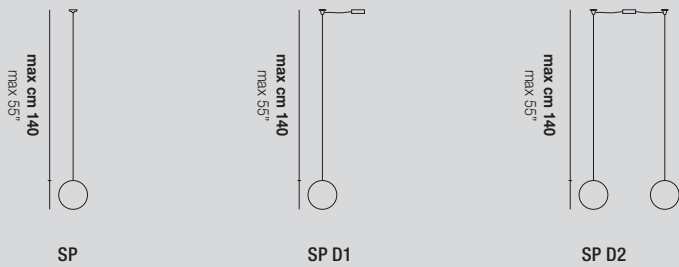

Nuova versione / New version

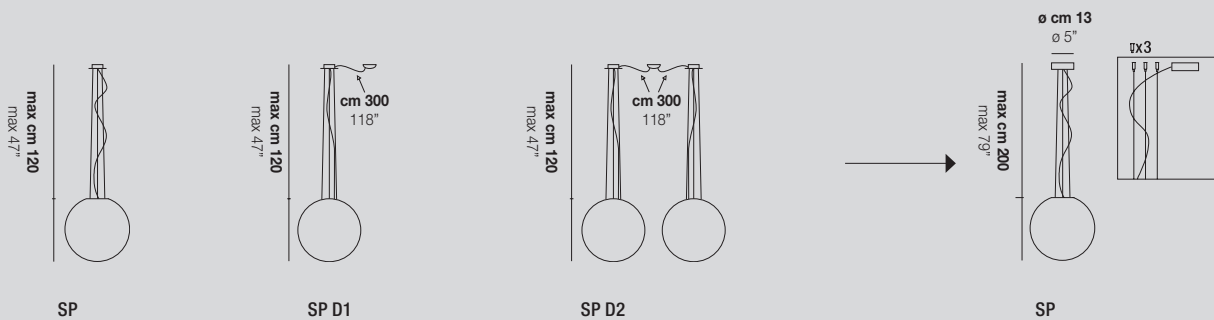
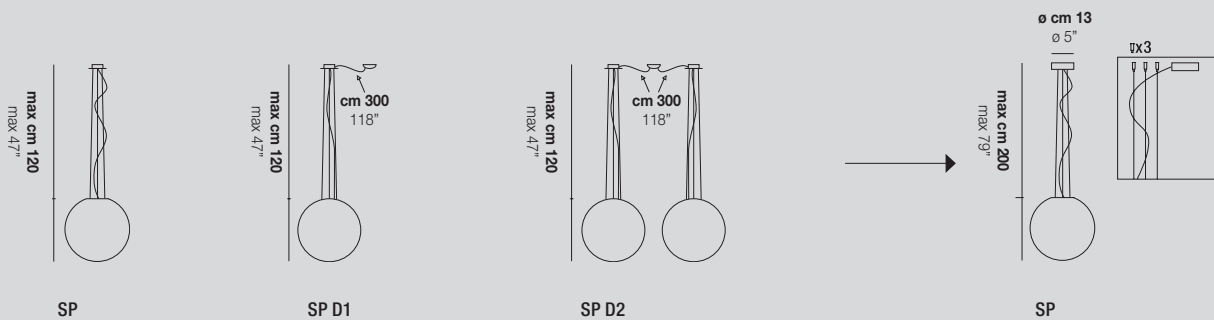
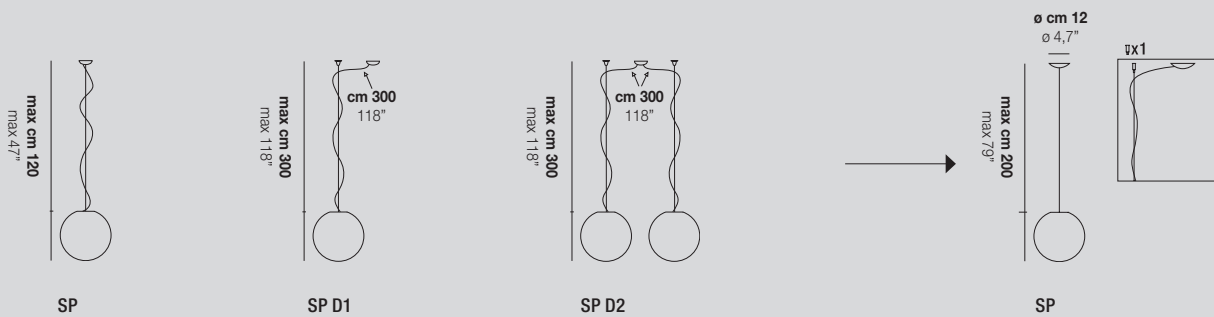
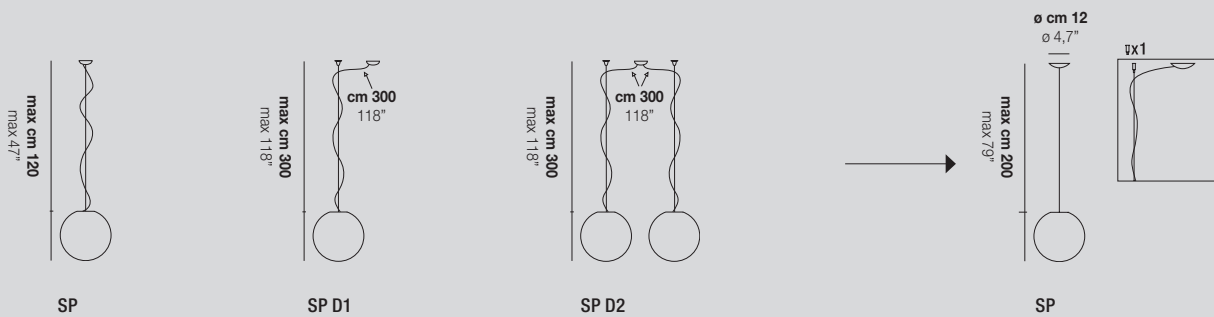
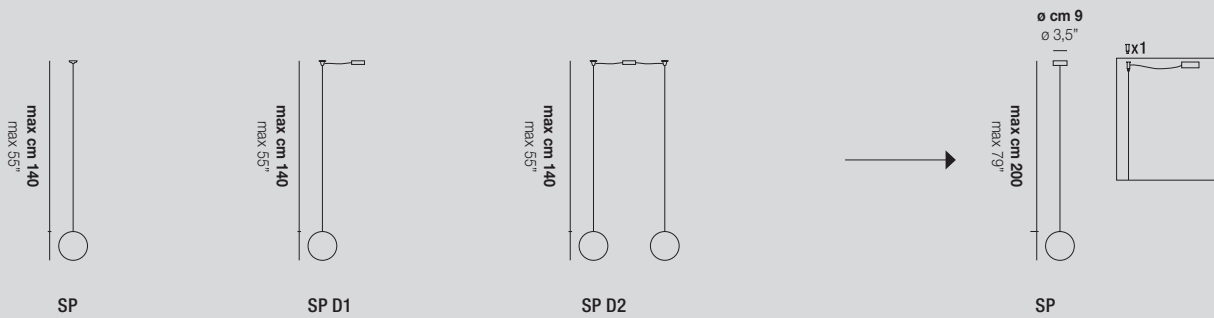

Decentramento a 2 luci per lampade con driver LED / Two lights swag system for lamps with LED driver

OLD
Doppio collegamento elettrico / dimmerazione
Double power / dimming supply

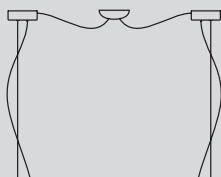

NEW
Singolo collegamento elettrico / dimmerazione
Single power / dimming supply

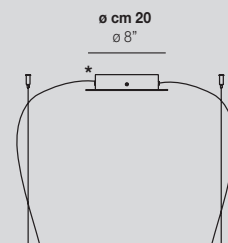
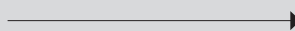

*Rosone da ordinare a parte
Canopy to be purchased separately

Nuove caratteristiche LED 2021 / New LED features 2021

LED A



LED B

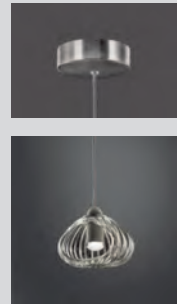

caratteristiche / features

		Europe	Usa & Canada
vita media / average lifetime	ore / h	45.000	45.000
flusso luminoso / luminous flux	lm	1.100 / 1.200	1.100 / 1.200
temperatura colore / colour temperature	°K option*	2700 3000	2700 3000
CRI	Ra	≥90	≥90
efficienza / efficiency	lm/W	120 / 130	120 / 130
tensione media / average tension	V	34	34
consumo / power consumption	W	9W @260mA	9W @260mA
dimmerazione / dimming	DIM2 DIM3*	Phase Cut / 0-10V, Push	Phase Cut / 0-10V, Push

		Europe	Usa & Canada
ore / h		45.000	45.000
lm		1.100 / 1.200	1.100 / 1.200
°K option*		2700 3000	2700 3000
Ra		≥90	≥90
lm/W		120 / 130	120 / 130
V		34	34
W		9W @260mA	9W @260mA
DIM2 DIM3*		Phase Cut / 0-10V, Push	Phase Cut / 0-10V, Push

* Altre opzioni disponibili su richiesta / Other options available on request

LED C



LED D



caratteristiche / features

		Europe	Usa & Canada
vita media / average lifetime	ore / h	40.000	40.000
flusso luminoso / luminous flux	lm	1.500 / 1.600	1.500 / 1.600
temperatura colore / colour temperature	°K option*	2700 3000	2700 3000
CRI	Ra	≥90	≥90
efficienza / efficiency	lm/W	110 / 120	110 / 120
tensione media / average tension	V	35	35
consumo / power consumption	W	12W @340mA	12W @340mA
dimmerazione / dimming	DIM2 DIM3*	Phase Cut / 0-10V, Push	Phase Cut / 0-10V, Push

		Europe	Usa & Canada
ore / h		45.000	45.000
lm		1.100 / 1.200	1.100 / 1.200
°K option*		2700 3000	2700 3000
Ra		≥90	≥90
lm/W		120 / 130	120 / 130
V		34	34
W		9W @260mA	9W @260mA
DIM2 DIM3*		Phase Cut / 0-10V, Push	Phase Cut / 0-10V, Push

* Altre opzioni disponibili su richiesta / Other options available on request

I dati riportati corrispondono ai valori nominali del modulo LED / Reported data corresponds to nominal ratings of the LED modules

Nuove caratteristiche LED 2021 / New LED features 2021

OLD



NEW*

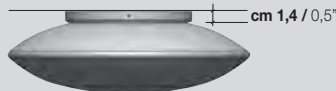

Altezza ridotta da 4,2 cm (1,5") a 1,4 cm (0,5")
Reduced height from 4,2 cm (1,5") to 1,4 cm (0,5")

LED F*



LED G*



caratteristiche / features

vita media / average lifetime	ore / h	50.000
flusso luminoso / luminous flux	lm	1.700
temperatura colore / colour temperature	°K option*	2700 3000
CRI	Ra	≥90
efficienza / efficiency	lm/W	140
tensione media / average tension	V	24
consumo / power consumption	W	12W @500mA
dimmerazione / dimming		DIM2 DIM3*

Europe

Usa & Canada

vita media / average lifetime	ore / h	50.000
flusso luminoso / luminous flux	lm	1.700
temperatura colore / colour temperature	°K option*	2700 3000
CRI	Ra	≥90
efficienza / efficiency	lm/W	140
tensione media / average tension	V	24
consumo / power consumption	W	12W @500mA
dimmerazione / dimming		Phase Cut / 0-10V, Push

Europe

Usa & Canada

vita media / average lifetime	ore / h	50.000
flusso luminoso / luminous flux	lm	2.850
temperatura colore / colour temperature	°K option*	2700 3000
CRI	Ra	≥90
efficienza / efficiency	lm/W	150
tensione media / average tension	V	39
consumo / power consumption	W	19W @500mA
dimmerazione / dimming		DIM2 DIM3*

* Altre opzioni disponibili su richiesta / Other options available on request

LED O*



LED 01



caratteristiche / features

vita media / average lifetime	ore / h	50.000
flusso luminoso / luminous flux	lm	3.700
temperatura colore / colour temperature	°K option*	2700 3000
CRI	Ra	≥90
efficienza / efficiency	lm/W	150
tensione media / average tension	V	39
consumo / power consumption	W	26W @700mA
dimmerazione / dimming		DIM2 DIM3*

Europe

Usa & Canada

vita media / average lifetime	ore / h	50.000
flusso luminoso / luminous flux	lm	3.700
temperatura colore / colour temperature	°K option*	2700 3000
CRI	Ra	≥90
efficienza / efficiency	lm/W	150
tensione media / average tension	V	39
consumo / power consumption	W	26W @700mA
dimmerazione / dimming		Phase Cut / 0-10V, Push

Europe

Usa & Canada

vita media / average lifetime	ore / h	40.000
flusso luminoso / luminous flux	lm	1.200
temperatura colore / colour temperature	°K option*	2700 3000
CRI	Ra	≥90
efficienza / efficiency	lm/W	150
tensione media / average tension	V	24
consumo / power consumption	W	8,5W @350mA
dimmerazione / dimming		DIM2 DIM3*

* Altre opzioni disponibili su richiesta / Other options available on request

I dati riportati corrispondono ai valori nominali del modulo LED / Reported data corresponds to nominal ratings of the LED modules

Nuove caratteristiche LED 2021 / New LED features 2021

LED 02



LED 03



caratteristiche / features

		Europe	Usa & Canada
vita media / average lifetime	ore / h	40.000	40.000
flusso luminoso / luminous flux	lm	2.000	2.000
temperatura colore / colour temperature	°K option*	2700 3000	2700 3000
CRI	Ra	≥90	≥90
efficienza / efficiency	lm/W	150	150
tensione media / average tension	V	37	37
consumo / power consumption	W	13W @350mA	13W @350mA
dimmerazione / dimming	DIM2 DIM3 *	Phase Cut / 0-10V, Push	Phase Cut / 0-10V, Push

		Europe	Usa & Canada
ore / h		35.000	35.000
lm		1.300	1.200
°K option*		3000	3000
Ra		≥90	≥90
lm/W		86	80
V		230	110
W		15W	15W
dimmerazione / dimming	DIM2 *	Phase cut	Phase cut

* Altre opzioni disponibili su richiesta / Other options available on request

LED 04



LED 05



caratteristiche / features

		Europe	Usa & Canada
vita media / average lifetime	ore / h	30.000	30.000
flusso luminoso / luminous flux	lm	2.000	2.000
temperatura colore / colour temperature	°K option*	2700 3000	2700 3000
CRI	Ra	≥90	≥90
efficienza / efficiency	lm/W	140	140
tensione media / average tension	V	28	28
consumo / power consumption	W	14W @500mA	14W @500mA
dimmerazione / dimming	DIM2 DIM3 *	Phase Cut / 0-10V, Push	Phase Cut / 0-10V, Push

		Europe	Usa & Canada
ore / h		90.000	90.000
lm		1.400	1.400
°K option*		2700 3000	2700 3000
Ra		≥90	≥90
lm/W		130	130
V		35	35
W		10,5W @300mA	10,5W @300mA
dimmerazione / dimming	DIM4 *	Push	Push

* Altre opzioni disponibili su richiesta / Other options available on request

I dati riportati corrispondono ai valori nominali del modulo LED / Reported data corresponds to nominal ratings of the LED modules

Nuove caratteristiche LED 2021 / New LED features 2021

LED 07



LED 08



caratteristiche / features

		Europe	Usa & Canada
vita media / average lifetime	ore / h	40.000	40.000
flusso luminoso / luminous flux	lm	2.850	2.850
temperatura colore / colour temperature	°K option*	2700 3000	2700 3000
CRI	Ra	≥90	≥90
efficienza / efficiency	lm/W	150	150
tensione media / average tension	V	39	39
consumo / power consumption	W	19,5W @500mA	19,5W @500mA
dimmerazione / dimming	DIM2 DIM3*	Phase Cut / 0-10V, Push	Phase Cut / 0-10V, Push

		Europe	Usa & Canada
vita media / average lifetime	ore / h	50.000	50.000
flusso luminoso / luminous flux	lm	3.800	3.800
temperatura colore / colour temperature	°K option*	2700 3000	2700 3000
CRI	Ra	≥80	≥80
efficienza / efficiency	lm/W	115	115
tensione media / average tension	V	24	24
consumo / power consumption	W	35W	35W
dimmerazione / dimming	DIM2*	Phase cut	Phase cut

* Altre opzioni disponibili su richiesta / Other options available on request

LED 09



LED 10



caratteristiche / features

		Europe	Usa & Canada
vita media / average lifetime	ore / h	40.000	40.000
flusso luminoso / luminous flux	lm	1.600	1.250
temperatura colore / colour temperature	°K option*	2700 3000	2700 3000
CRI	Ra	≥90	≥90
efficienza / efficiency	lm/W	150	150
tensione media / average tension	V	25	25
consumo / power consumption	W	11,5W @400mA	8,5W @300mA
dimmerazione / dimming	DIM2 DIM3*	Phase Cut / 0-10V, Push	Phase Cut / 0-10V, Push

		Europe	Usa & Canada
vita media / average lifetime	ore / h	90.000	90.000
flusso luminoso / luminous flux	lm	1.500	1.500
temperatura colore / colour temperature	°K option*	2700 3000	2700 3000
CRI	Ra	≥90	≥90
efficienza / efficiency	lm/W	130	130
tensione media / average tension	V	35	35
consumo / power consumption	W	12,5W @350mA	12,5W @350mA
dimmerazione / dimming	DIM2 DIM3*	Phase Cut / 0-10V, Push	Phase Cut / 0-10V, Push

* Altre opzioni disponibili su richiesta / Other options available on request

I dati riportati corrispondono ai valori nominali del modulo LED / Reported data corresponds to nominal ratings of the LED modules

Nuove caratteristiche LED 2021 / New LED features 2021

LED 11

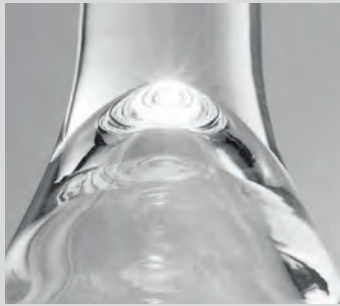

LED 12

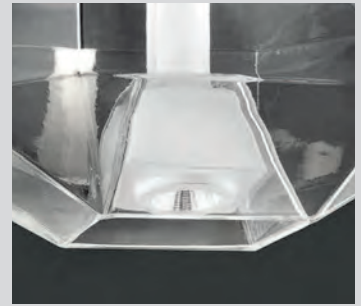

caratteristiche / features

		Europe	Usa & Canada
vita media / average lifetime	ore / h	40.000	40.000
flusso luminoso / luminous flux	lm	1.500 / 1.600	1.500 / 1.600
temperatura colore / colour temperature	°K option*	2700 3000	2700 3000
CRI	Ra	≥90	≥90
efficienza / efficiency	lm/W	110 / 120	110 / 120
tensione media / average tension	V	35	35
consumo / power consumption	W	12W @340mA	12W @340mA
dimmerazione / dimming	DIM2 DIM3 *	Phase Cut / 0-10V, Push	Phase Cut / 0-10V, Push

		Europe	Usa & Canada
ore / h		50.000	50.000
flusso luminoso / luminous flux	lm	1.000 / 1.200	1.000 / 1.200
temperatura colore / colour temperature	°K option*	2700 3000	2700 3000
CRI	Ra	≥90	≥90
efficienza / efficiency	lm/W	110	110
tensione media / average tension	V	29	29
consumo / power consumption	W	2W+8W @350mA	2W+8W @350mA
dimmerazione / dimming	DIM2 DIM3 *	Phase Cut / 0-10V, Push	Phase Cut / 0-10V, Push

* Altre opzioni disponibili su richiesta / Other options available on request

LED 13



LED 14



caratteristiche / features

		Europe	Usa & Canada
vita media / average lifetime	ore / h	40.000	40.000
flusso luminoso / luminous flux	lm	1.500 / 1.600	1.500 / 1.600
temperatura colore / colour temperature	°K option*	2700 3000	2700 3000
CRI	Ra	≥90	≥90
efficienza / efficiency	lm/W	110 / 120	110 / 120
tensione media / average tension	V	35	35
consumo / power consumption	W	12W @340mA	12W @340mA
dimmerazione / dimming	DIM2 DIM3 *	Phase Cut / 0-10V, Push	Phase Cut / 0-10V, Push

		Europe	Usa & Canada
ore / h		40.000	40.000
flusso luminoso / luminous flux	lm	1.200	1.200
temperatura colore / colour temperature	°K option*	2700 3000	2700 3000
CRI	Ra	≥90	≥90
efficienza / efficiency	lm/W	150	150
tensione media / average tension	V	24	24
consumo / power consumption	W	8,5W @350mA	8,5W @350mA
dimmerazione / dimming	DIM2 DIM3 *	Phase Cut / 0-10V, Push	Phase Cut / 0-10V, Push

* Altre opzioni disponibili su richiesta / Other options available on request

I dati riportati corrispondono ai valori nominali del modulo LED / Reported data corresponds to nominal ratings of the LED modules

Nuove caratteristiche LED 2021 / New LED features 2021

LED 15



LED 16



caratteristiche / features

		Europe	Usa & Canada
vita media / average lifetime	ore / h	40.000	40.000
flusso luminoso / luminous flux	lm	2.000	2.000
temperatura colore / colour temperature	°K option*	2700 3000	2700 3000
CRI	Ra	≥90	≥90
efficienza / efficiency	lm/W	150	150
tensione media / average tension	V	37	37
consumo / power consumption	W	13W @350mA	13W @350mA
dimmerazione / dimming	DIM4*	Push	Push

		Europe	Usa & Canada
vita media / average lifetime	ore / h	40.000	40.000
flusso luminoso / luminous flux	lm	1.200	1.200
temperatura colore / colour temperature	°K option*	2700 3000	2700 3000
CRI	Ra	≥90	≥90
efficienza / efficiency	lm/W	150	150
tensione media / average tension	V	24	24
consumo / power consumption	W	8,5W @350mA	8,5W @350mA
dimmerazione / dimming	DIM4*	Push	Push

* Altre opzioni disponibili su richiesta / Other options available on request

LED 17



LED 18



caratteristiche / features

		Europe	Usa & Canada
vita media / average lifetime	ore / h	50.000	50.000
flusso luminoso / luminous flux	lm	1.250	1.250
temperatura colore / colour temperature	°K option*	2700 3000	2700 3000
CRI	Ra	≥90	≥90
efficienza / efficiency	lm/W	150	150
tensione media / average tension	V	24	24
consumo / power consumption	W	8,5W @300mA	8,5W @300mA
dimmerazione / dimming	DIM2 DIM3*	Phase Cut / 0-10V, Push	Phase Cut / 0-10V, Push

		Europe	Usa & Canada
vita media / average lifetime	ore / h	30.000	30.000
flusso luminoso / luminous flux	lm	1.900	1.900
temperatura colore / colour temperature	°K option*	2700 3000	2700 3000
CRI	Ra	≥90	≥90
efficienza / efficiency	lm/W	150	150
tensione media / average tension	V	24	24
consumo / power consumption	W	12W @500mA	12W @500mA
dimmerazione / dimming	DIM2 DIM3*	Phase Cut / 0-10V, Push	Phase Cut / 0-10V, Push

* Altre opzioni disponibili su richiesta / Other options available on request

I dati riportati corrispondono ai valori nominali del modulo LED / Reported data corresponds to nominal ratings of the LED modules

Nuove caratteristiche LED 2021 / New LED features 2021

LED 19



LED 20



caratteristiche / features

		Europe	Usa & Canada
vita media / average lifetime	ore / h	30.000	30.000
flusso luminoso / luminous flux	lm	2.800	2.800
temperatura colore / colour temperature	°K option*	2700 3000	2700 3000
CRI	Ra	≥90	≥90
efficienza / efficiency	lm/W	150	150
tensione media / average tension	V	36,5	36,5
consumo / power consumption	W	18W @500mA	18W @500mA
dimmerazione / dimming	DIM2 DIM3 *	Phase Cut / 0-10V, Push	Phase Cut / 0-10V, Push

		Europe	Usa & Canada
ore / h		40.000	40.000
lm		600	600
°K option*		2700 3000	2700 3000
Ra		≥90	≥90
lm/W		120	120
V		10	10
W		5W @500mA	5W @500mA
DIM2 DIM3 *		Phase Cut / 0-10V, Push	Phase Cut / 0-10V, Push

* Altre opzioni disponibili su richiesta / Other options available on request

Ideazione grafica

Studio Pointer

Fotografia

Studio Pointer

Quasar

Max Zambelli

Paolo Utimpergher (pag. 330, 70)

Fotolito

Studio Pointer

DiTre

Ringraziamenti:

foto Tubes PL 15 (pag. 272)

ph Luis Eduardo Guillen

architetti: dos G arquitectos, Ginnette Gotti e Ivan Grippaldi

c/o OCEANÍA BUSINESS PLAZA

42° piano, Torre 2000 Panama, Repubblica di Panama

AD DAL POZZO – Architettura e Design

ARCHIPRODUCTS – photo by Andrea di Lorenzo

DE MARCHI ARREDAMENTI S.r.l.

L'ARREDAMENTO S.r.l.

Stampa

Grafiche Gemma

Edizione n° 1 - Aprile 2021

Catalog_2 - rev. 19

© Copyright - Vetreria Vistosi s.r.l.

Proprietà artistica e letteraria

riservata in tutto il mondo.

È vietata la riproduzione, anche parziale,
dei testi, dei disegni, delle immagini e qualsiasi
contenuto in genere senza autorizzazione.

Artistic and literary property reserved worldwide.

Reproduction, even partial, of texts, drawings,
images and any content in general is prohibited
without permission.



UNI EN ISO 9001 - CERTIFIED COMPANY



Vetreria Vistosi s.r.l.

Via Galileo Galilei, 9-9/A-11

31021 Mogliano Veneto - Treviso (Italy)

Tel +39 041 5903480 · +39 041 5900170

Fax +39 041 5900992 · +39 041 5904540

www.vistosi.it · vistosi@vistosi.it

