

marelli

**NEW
COLLECTION
2023**

marelli

NEW
COLLECTION
2023

INDICE
INDEX

ARTHUR	COFFE TABLE
BRERA	ARMCHAIR
CHIA	ARMCHAIR
KOFI	COFFE TABLE
LINDA	ARMCHAIR
MILO	ARMCHAIR AND SOFA
NOAH	ARMCHAIR AND SOFA
ONNO	TABLE, COFFE TABLE AND BOOKSHELF
SIGN	ARMCHAIR
THEO	SIDEBOARD AND MIRROR
WAVE	TABLE AND COFFE TABLE
YANN	ARMCHAIR AND SOFA



BRERA armchairs
9BRE106 cm 80x82x101h
 Leather: cat. Extra art. Levante 5608
 Base: OPM15 antique gold brushed metal

WAVE side table
7WA101 ø cm 50x47h
 Top: OPP7 Calacatta gold marble
 Base: OPM20 Délabré brass brushed metal



BRERA armchairs
9BRE106 cm 80x82x101h
 Leather: cat. Extra art. Levante 5608
 Base: OPM15 antique gold brushed metal

WAVE side table
7WA101 ø cm 50x47h
 Top: OPP7 Calacatta gold marble
 Base: OPM20 Délabré brass brushed metal





MILO composition cm 476x317
Fabric: cat. D/E art. Clusone col. 08

Cushions:
2 x 9CU104 cm 40x40
2 x 9CU106 cm 45x45
Fabric: cat. D/E art. Clusone 08
2 x 9CU106 cm 45x45
Fabric: cat. H art. Misia M261 80 1 Ivory
1 x 9CU106 cm 45x45
1 x 9CU104 cm 60x60
Leather: cat. Extra art. Levante 5608

ONNO coffee tables
70N105 cm 120x120x25h
70N102 ø cm 60x35h
70N110 ø cm 90x25h
70N101 cm 60x60x35h
70N104 ø cm 45x45h
Bases: OPR15 moka matt stained oak
+ OPM20 Délabré brass brushed metal
Top: OPP7 Calacatta marble

MILO composition cm 476x317
Fabric: cat. D/E art. Clusone col. 08

MILO armchair
9MIL101 cm 96x76x70h
Fabric: cat. F/G art. Orsetto 1/1

Cushions:
2 x 9CU104 cm 40x40
2 x 9CU106 cm 45x45
Fabric: cat. D/E art. Clusone 08
2 x 9CU106 cm 45x45
Fabric: cat. H art. Misia M261 80 1 Ivory
1 x 9CU106 cm 45x45
1 x 9CU104 cm 60x60
Leather: cat. Extra art. Levante 5608

MILO composition cm 208x107
Leather: cat. Extra art. Levante 5608

Cushions:
1 x 9CU104 cm 60x60
Leather: cat. Extra art. Levante 5608

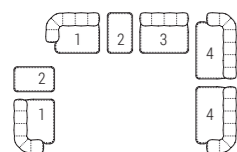

1 - 9MIL301
2 - 9MIL110
3 - 9MIL401
4 - 9MIL302

10



11

ONNO coffee tables
7ON105 cm 120x120x25h
7ON102 ø cm 60x35h
7ON110 ø cm 90x25h
7ON101 cm 60x60x35h
7ON104 ø cm 45x45h
Bases: OPR15 moka matt stained oak
+ OPM20 Délabré brass brushed metal
Top: OPP7 Calacatta marble



MILO composition cm 476x317
Fabric: cat. D/E art. Clusone col. 08

Cushions:
2 x 9CU104 cm 40x40
2 x 9CU106 cm 45x45
Fabric: cat. D/E art. Clusone 08
2 x 9CU106 cm 45x45
Fabric: cat. H art. Misia M261 80 1 Ivory
1 x 9CU106 cm 45x45
1 x 9CU104 cm 60x60
Leather: cat. Extra art. Levante 5608

MILO composition cm 208x107
Leather: cat. Extra art. Levante 5608

Cushions:
1 x 9CU104 cm 60x60
Leather: cat. Extra art. Levante 5608

ONNO coffee tables
7ON105 cm 120x120x25h
7ON102 ø cm 60x35h
7ON110 ø cm 90x25h
7ON101 cm 60x60x35h
7ON104 ø cm 45x45h
Bases: OPR15 moka matt stained oak
+ OPM20 Délabré brass brushed metal
Top: OPP7 Calacatta marble

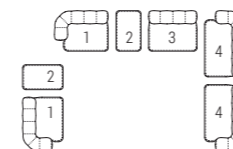

1 - 9MIL301
2 - 9MIL110
3 - 9MIL401
4 - 9MIL302



Details of **MILO** sofa in fabric cat. D/E art. Clusone 08

ONNO side table
70x103 cm 45x45x45h
 Top: OPP7 Calacatta marble
 Base: OPR15 moka matt stained oak + OPM20 Délabré brass
 brushed metal



MILO composition cm 350x107x70h
Fabric: cat. D/E art. Clusone 08

Cushions:
1 x 9CU104 cm 60x60
Leather: cat. Extra art. Levante 5608
1 x 9CU104 cm 60x60
1 x 9CU106 cm 45x45
Fabric: cat. D/E art. Clusone 08
1 x 9CU106 cm 45x45
Fabric: cat. H art. Misia M261 80 1 Ivory

ONNO coffee tables
7ON110 ø cm 90x25h
7ON101 cm 60x60x35h
Bases: OPR15 moka matt stained oak
+ OPM20 Délabré brass brushed metal
Top: OPP7 Calacatta marble



1 - 9MIL302





MILO armchair
9MIL101 cm 96x76x70h
Fabric: cat. F/G art. Orsetto 1/1



Details of **MILO** sofa

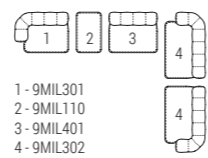



1 - 9MIL301
2 - 9MIL110



Details of **MILO** sofa in leather cat. Extra art. Levante 5608

MILO sofa
9MIL202 cm 255x107x70h
9CU106 cm 45x45
9CU104 cm 60x60
Leather: cat. Extra art. Levante 5608

ONNO server table
7ON104 ø cm 45x45h
Top: OPP7 Calacatta marble
Base: OPM18 anodyc bronze painted metal
+ OPM20 Délabré brass brushed metal





ONNO coffee tables
7ON105 cm 120x120x25h
7ON101 cm 60x60x35h
7ON110 ø cm 90x25h
7ON104 ø cm 45x45h
 Bases: OPR15 moka matt stained oak + OPM20
 Délabré brass brushed metal
 Top: OPP7 Calacatta marble



ONNO coffee tables
7ON105 cm 120x120x25h
7ON101 cm 60x60x35h
7ON110 ø cm 90x25h
7ON103 cm 45x45x45h
 Top: OPP7 Calacatta marble
 Bases: OPR15 moka matt stained oak
 + OPM20 Délabré brass brushed metal
7ON103 cm 45x45x45h
 Top: OPP7 Calacatta marble
 Base: OPM20 Délabré brass brushed metal
 + OPM18 anodyc bronze painted metal



MILO chaise longue
9MIL202 cm 142x142x70h
2 x Cushions 9CU106 cm 45x45
Fabric: cat. D/E art. Persiano col. 208

ONNO server table
7ON103 cm 45x45x45h
Top: OPP7 Calacatta marble
Base: OPM20 Délabré brass wooden painted leg
+ OPM18 anodyc bronze painted metal



28



29



MILO composition cm 420x167
Fabric: cat. F/G art. Orsetto 05/6

Cushions:
3 x 9CU104 cm 60x60
2 x 9CU106 cm 45x45
Fabric: cat. F/G art. Orsetto 05/6

KOFI coffee tables:
7KO103 cm 120x120x28h
7KO101 cm 60x60x48h
Base: OPM23 Tobacco painted metal
Top: OPP7 Calacatta marble

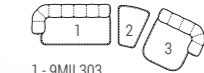

1 - 9MIL303
2 - 9MIL112
3 - 9MIL102



MILO composition cm 350x142
Fabric: cat. F/G art. Orsetto 05/6

KOFI coffee table:
7KO202 cm 90x90x28h
Base: OPM20 Délabré brass brushed metal
Top: OPV9 chrome back-painted bronze glass

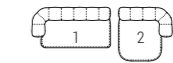

1 - 9MIL303
2 - 9MIL102



ONNO dining table
70N103 ø cm 160x74h
Top: OPP7 Calacatta marble
Bases: OPM20 Délabré brass brushed metal +
OPM18 anodized bronze painted metal

LINDA chairs
9LIN102 cm 62x58x78h
Fabric: cat. D/E art. Persiano col. 208
Base: OPM15 antique gold brushed metal





LINDA chair
9LIN102 cm 62x58x78h
Fabric: cat. D/E art. Persiano col. 208
Base: OPM15 antique gold brushed metal

SIGN armchair
95x112 cm 83x75x75h
Fabric: cat. F/G art. Misia Aime M188 227 Vert
Empire
Base: OPM15 antique gold brushed metal





- 1 - 7YA102
 2 - 9YA301
 3 - 9YA601
 4 - 9YA204
-

YANN composition cm 423x233
 Fabric: cat. F/G art. Casamance Lierna 4976 0327 sable
YANN table
7YA102: OPM20 Délabré brass brushed painted metal

Cushions:
3 x 9CU106 cm 45x45
 Fabric: cat. F/G art. Casamance Lierna 4976 0327 sable
2 x 9CU106 cm 45x45
 Fabric: cat. F/G art. Misia Aime M188 631 Terre d'ombre
2 x 9CU106 cm 45x45
 Fabric: cat. D/E art. Persiano col. 208

KOFI coffee tables:
7K0102 cm 90x90x28h
 Base: OPM23 Tobacco painted metal
 Top: OPP7 Calacatta marble
7K0101 cm 60x60x48h
 Base: OPM20 Délabré brass brushed painted metal
 Top: OPP7 Calacatta marble

ONNO server table
7ON103 cm 45x45x45h
 Top: OPP7 Calacatta marble
 Base: OPR15 moka matt stained oak
 + OPM20 Délabré brass brushed metal

- 1 - 7YA102
- 2 - 9YA301
- 3 - 9YA601
- 4 - 9YA204



YANN composition cm 423x233
 Fabric: cat. F/G art. Casamance Lierna 4976 0327 sable
 YANN table 7YA102: OPM20 Délabré brass brushed painted metal

Cushions:
3 x 9CU106 cm 45x45
 Fabric: cat. F/G art. Casamance Lierna 4976 0327 sable
2 x 9CU106 cm 45x45
 Fabric: cat. F/G art. Misia Aime M188 631 Terre d'ombre
2 x 9CU106 cm 45x45
 Fabric: cat. D/E art. Persiano col. 208

SIGN armchairs
9SI112 cm 83x75x75h
 Fabric: Cat. F/G art. Misia Aime M188 631 Terre d'ombre
 Base: OPM15 antique gold brushed metal

WAVE tables
7WA104 ø cm 120x27h
7WA101 ø cm 50x47h
7WA102 ø cm 60x37h
 Top: OPP13 Velvet brown marble
 Base: OPM19 Délabré Pewter brushed metal
7WA106 ø cm 50x47h
7WA107 ø cm 60x37h
 Base and top: OPM19 Délabré Pewter brushed metal

- 1 - 7YA102
- 2 - 9YA301
- 3 - 9YA601
- 4 - 9YA204



- 1 - 7YA102
- 2 - 9YA301
- 3 - 9YA601
- 4 - 9YA204

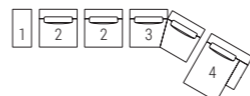

Detail of **YANN** sofa with table
in OPM20 Délabré brass brushed metal

KOFI coffee tables:
7K0102 cm 90x90x28h
Base: OPM23 Tobacco painted metal
Top: OPP7 Calacatta marble
7K0101 cm 60x60x48h
Base: OPM20 Délabré brass brushed metal
Top: OPP7 Calacatta marble

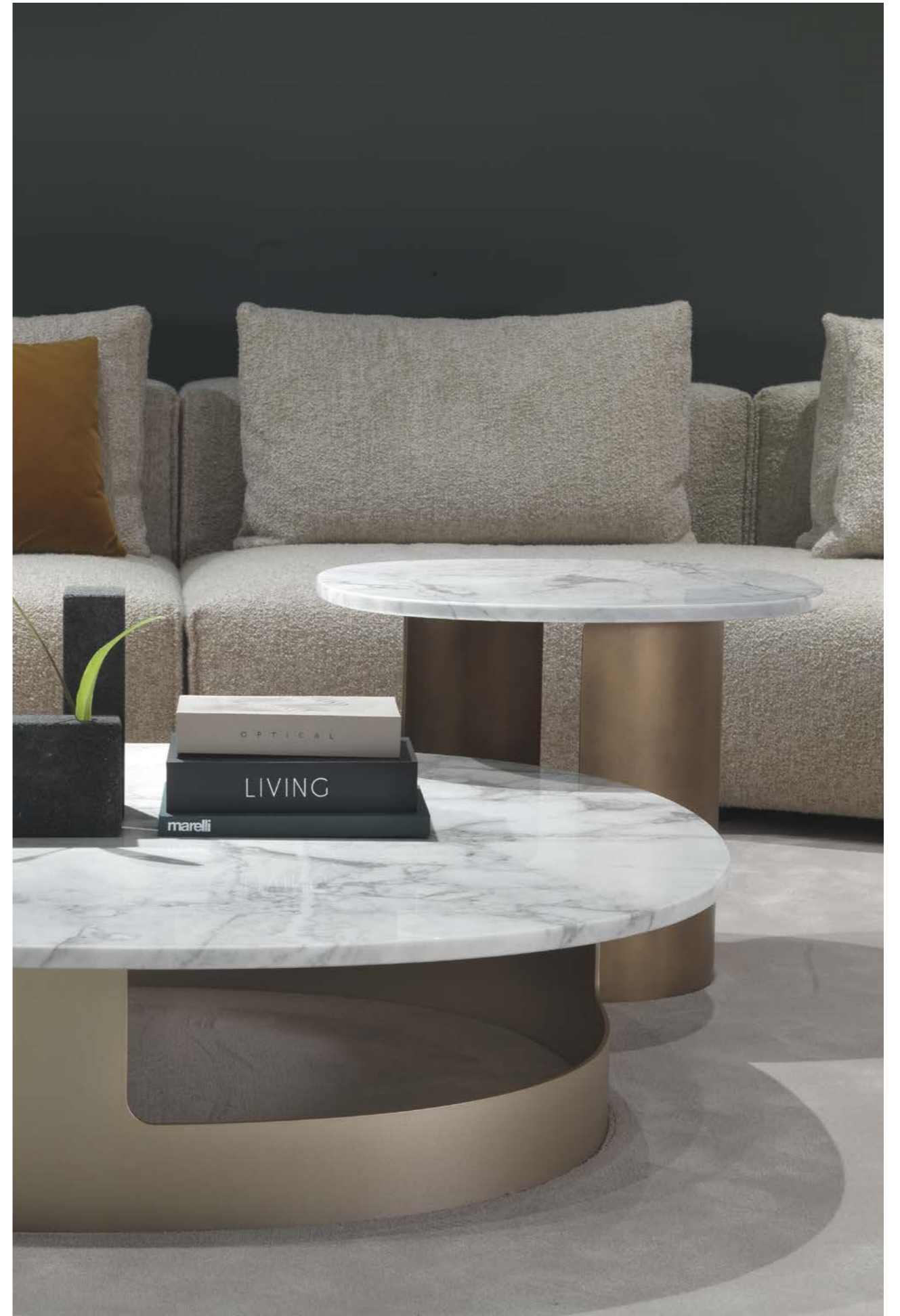

SIGN armchairs
9SI112 cm 83x75x75h
Fabric: Cat. F/G art. Misia Aime M188 631 Terre d'ombre
Base: OPM15 antique gold brushed metal

YANN composition cm 423x233
Fabric: cat. F/G art. Casamance Lierna 4976 0327 sable
YANN table
7YA102: OPM20 Délabré brass brushed painted metal

KOFI coffee tables:
7KO102 cm 90x90x28h
7KO101 cm 60x60x48h
Base: OPM23 Tobacco painted metal
Top: OPP7 Calacatta marble

ONNO server table
7ON103 cm 45x45x45h
Top: OPP7 Calacatta marble
Base: OPR15 moka matt stained oak
+ OPM20 Délabré brass brushed metal



46



47



Detail of **YANN** sofa

ONNO server table
70x103 cm 45x45x45h
Top: OPP7 Calacatta marble
Base: OPR15 moka matt stained oak
+ OPM20 Délabré brass brushed metal





Details of **YANN** composition



- 1 - 7YA102
- 2 - 9YA301
- 3 - 9YA601
- 4 - 9YA204

LINDA chairs
9LIN102 cm 62x58x78h
Fabric: cat. F/G art. Casamance Lierna 4976
0327 sable
Base: OPM15 antique gold brushed metal

THEO sideboard
7THE103 cm 240x55x70h
Top: OPP7 Calacatta marble
Structure: OPR15 moka matt stained oak
Handles: OPM15 antique gold brushed metal

THEO mirror
7THE101 cm 110x105x4.5
Bronze mirror
Structure: green painted oak

ONNO dining table
7ON201 cm 260x120x74h
Top: OPP7 Calacatta gold marble
Base: Green painted oak + OPR15 moka
matt stained oak

ONNO bookshelf
7ON301 cm 200x38x198h
Tops: OPR15 moka matt stained oak
Structure: green painted oak





ONNO dining table
7ON201 cm 260x120x74h
Top: OPP7 Calacatta gold marble
Base: Green painted oak + OPR15 moka matt stained oak

LINDA chairs
9LIN102 cm 62x58x78h
Fabric: cat. F/G art. Casamance Lierna 4976 0327 sable
Base: OPM15 antique gold brushed metal

THEO sideboard
7THE103 cm 240x55x70h
Top: OPP7 Calacatta marble
Structure: OPR15 moka matt stained oak
Handles: OPM15 antique gold brushed metal

THEO mirror
7THE101 cm 110x105x4.5
Bronze mirror
Structure: green painted oak

ONNO dining table
70N201 cm 260x120x74h
Top: OPP7 Calacatta gold marble
Base: Green painted oak
+ OPR15 moka matt stained oak

LINDA chairs
9LIN102 cm 62x58x78h
Fabric: cat. F/G art. Casamance Lierna 4976 0327 sable
Base: OPM15 antique gold brushed metal





LINDA chairs
9LIN102 cm 62x58x78h
 Fabric: cat. F/G art. Casamance Lierna 4976
 0327 sable
 Base: OPM15 antique gold brushed metal

Details of OPP7 Calacatta marble





THEO sideboard
7THE103 cm 240x55x70h
 Top: OPP7 Calacatta marble
 Structure: OPR15 moka matt stained oak
 Handles: OPM15 antique gold brushed metal

THEO mirror
7THE101 cm 110x105x4.5
 Bronze mirror
 Structure: green painted oak

ONNO dining table
7ON201 cm 260x120x74h
 Top: OPP7 Calacatta gold marble
 Base: Green painted oak
 + OPR15 moka matt stained oak

LINDA chairs
9LIN102 cm 62x58x78h
 Fabric: cat. F/G art. Casamance Lierna 4976 0327 sable
 Base: OPM15 antique gold brushed metal



ONNO bookshelf
70N301 cm 200x38x198h
Tops: OPR15 moka matt stained oak
Structure: green painted oak



THEO sideboard
7THE103 cm 240x55x70h
Structure: OPR15 moka matt stained oak
Top: OPP13 Velvet brown marble





ONNO dining table
7ON201 cm 260x120x74h
 Top: OPP7 Calacatta gold marble
 Base: Green painted oak + OPR15 moka matt stained oak

LINDA chairs
9LIN102 cm 62x58x78h
 Fabric: cat. F/G art. Casamance Lierna 4976 0327 sable
 Base: OPM15 antique gold brushed metal

THEO sideboard
7THE103 cm 240x55x70h
 Top: OPP7 Calacatta marble
 Structure: OPR15 moka matt stained oak
 Handles: OPM15 antique gold brushed metal

ONNO bookshelf
7ON301 cm 200x38x198h
 Tops: OPR15 moka matt stained oak
 Structure: green painted oak

THEO mirror
7THE101 cm 110x105x4.5
 Bronze mirror
 Structure: green painted oak

NOAH sofa 9NH202 cm 250x100x80h
2 x Cushions **9CU106 cm 45x45**
Fabric: cat. H art. Etamine Arles col. 883

WAVE coffee tables
7WA104 ø cm 120x27h
7WA102 ø cm 60x37h
7WA101 ø cm 50x47h
Top: OPP17 Port Laurent marble
Base: OPM20 Délabré brass brushed metal



WAVE coffee tables
7WA104 ø cm 120x27h
7WA102 ø cm 60x37h
7WA101 ø cm 50x47h
 Top: OPP17 Port Laurent marble
 Base: OPM20 Délabré brass brushed metal

WAVE coffee tables
7WA104 ø cm 120x27h
7WA101 ø cm 50x47h
7WA102 ø cm 60x37h
Top: OPP17 Port Laurent marble
Base: OPM20 Délabré brass brushed metal

NOAH curved sofa
9NH301 cm 250x100x80h
2 x Cushions
9CU106 cm 45x45
Fabric: cat. H art. Dedar Belsuede Camel T14040/022

NOAH armchair
9NH101 cm 90x90x76,5h
Fabric: cat. H art. Etamine Arles 19612 883



NOAH curved sofa
9NH301 cm 250x100x80h
2 x Cushions 9CU106 cm 45x45
 Fabric: cat. H art. Dedar Belsuede Camel T14040/022

NOAH armchair
9NH101 cm 90x90x76,5h
 Fabric: cat. H art. Etamine Arles 19612 883

ARTHUR coffee tables
7ART202 ø cm 60x40h
7ART203 ø cm 120x30h
 Top: OPP7 Calacatta marble
 Base: OPM20 Délabré brass brushed metal





WAVE coffee table
7WA101 ø cm 50x47h
 Top: OPP17 Port Laurent marble
 Base: OPM20 Délabré brass brushed metal

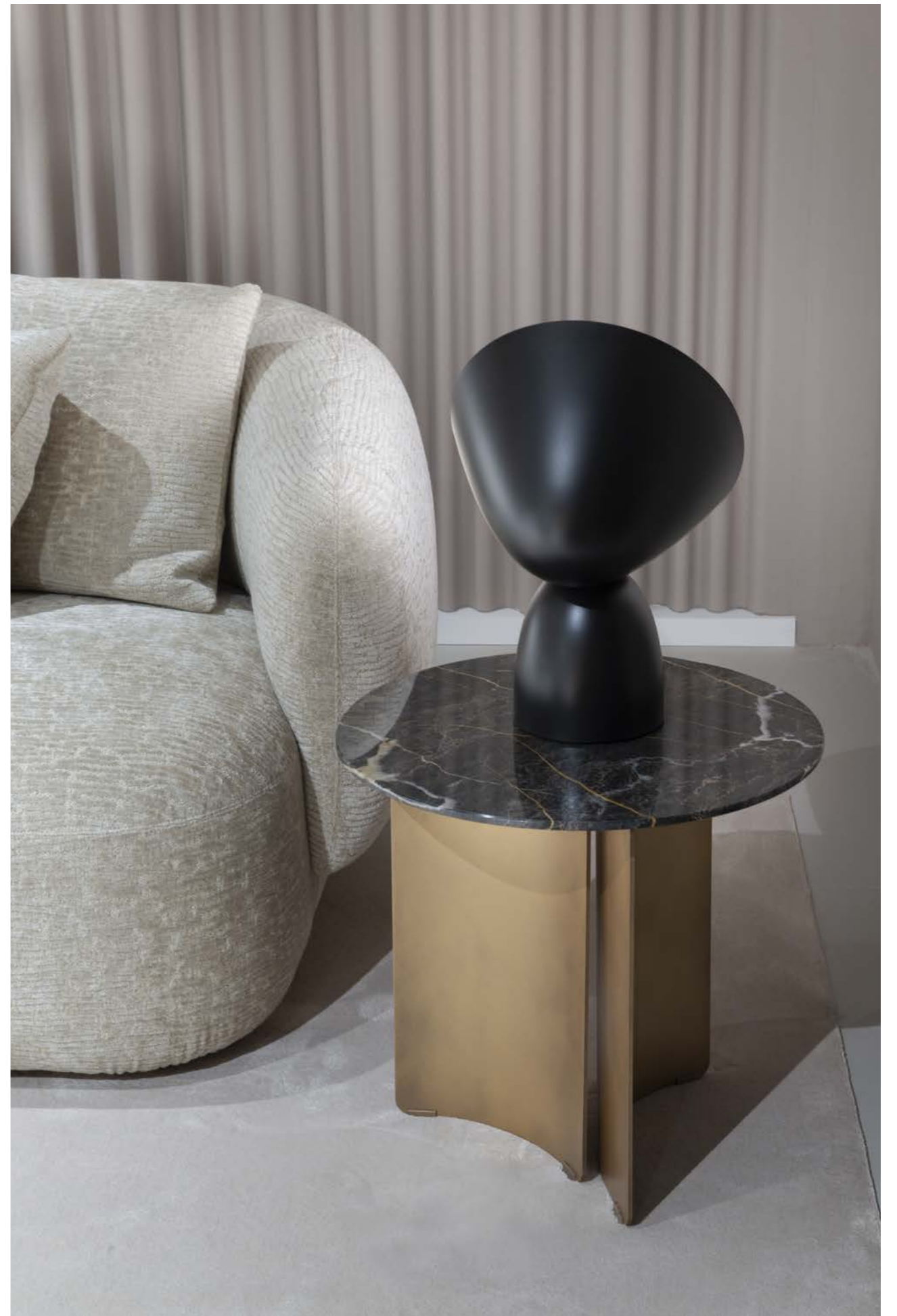

THEO sideboard
7THE103 cm 240x55x70h
Structure: OPR15 moka matt stained oak
Top: OPP13 Velvet brown marble

THEO mirror **7THE102 cm 170x180hx4,5 d**
Bronze mirror and Green painted oak
structure

WAVE dining table
7WA201 cm 260x110x74h
Base: OPM20 Délabré brass brushed metal
Top: OPP13 Velvet brown marble

CHIA chairs
9CHI104 cm 58x53x77h
Outside: leather cat. Extra art. Levante C/5608
Inside: Fabric cat. F/G art. Alma 4388 1245
Base: OPM15 antique gold brushed metal





WAVE dining table
7WA201 cm 260x110x74h
Base: OPM20 Délabré brass brushed metal
Top: OPP13 Velvet brown marble

CHIA chairs
9CHI104 cm 58x53x77h
Outside: leather cat. Extra art. Levante C/5608
Inside: Fabric cat. F/G art. Alma 4388 1245
Base: OPM15 antique gold brushed metal

THEO mirror
7THE102 cm 170x180hx4,5d
Bronze mirror and Green painted oak structure





CHIA chairs
9CHI104 cm 58x53x77h
 Outside: leather cat. Extra art. Levante C/5608
 Inside: Fabric cat. F/G art. Alma 4388 1245
 Base: OPM15 antique gold brushed metal

marelli





NEW
COLLECTION
2023

COLORI E FINITURE
COLOURS AND FINISHES

FINITURE METALLO

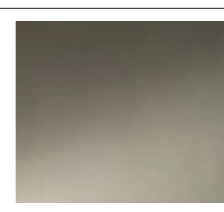
METAL FINISHES

<p>OPM1 Metallo cromo lucido <i>Shiny chrome metal</i> <i>Metall glänzend verchromt</i> <i>Métal chromé brillant</i></p>		<p>OPM9 Metallo verniciato classic bronze <i>Classic bronze painted metal</i> <i>Metall classic bronze lackiert</i> <i>Métal laqué classic bronze</i></p>	
<p>OPM2 Metallo spazzolato cromo satinato <i>Brushed matt chrome metal</i> <i>Metall matt verchromt (gebürstet)</i> <i>Métal chromé mat (brossé)</i></p>		<p>OPM10 Metallo verniciato golden beach <i>Golden beach painted metal</i> <i>Metall golden beach lackiert</i> <i>Métal laqué golden beach</i></p>	
<p>OPM3 Metallo spazzolato canna di fucile <i>Brushed matt dark grey metal</i> <i>Metall dunkelgrau gebürstet</i> <i>Métal brossé canon de fusil</i></p>		<p>OPM18 Metallo verniciato anodyc bronze <i>Anodyc bronze painted metal</i> <i>Métal laqué anodyc bronze</i> <i>Metall Anodyc Bronze lackiert</i></p>	
<p>OPM6 Metallo verniciato RAL 9017 nero <i>RAL 9017 black painted metal</i> <i>Metall RAL 9017 schwarz lackiert</i> <i>Métal laqué noir RAL 9017</i></p>		<p>OPM11 Metallo verniciato gold pearl <i>Gold pearl painted metal</i> <i>Metall gold pearl lackiert</i> <i>Métal laqué gold pearl</i></p>	
<p>OPM7 Metallo verniciato RAL 9016 bianco <i>RAL 9016 white painted metal</i> <i>Metall RAL 9016 weiss lackiert</i> <i>Métal laqué blanc RAL 9016</i></p>		<p>OPM12 Metallo spazzolato rame <i>Brushed copper metal</i> <i>Metall Kupfer gebürstet</i> <i>Métal brossé cuivre</i></p>	

<p>OPM13 Metallo spazzolato ottone antico <i>Brushed antique brass metal</i> <i>Metall Antik Messing gebürstet</i> <i>Métal brossé laiton antique</i></p>		<p>OPM19 Metallo spazzolato peltro Délabré <i>Délabré pewter brushed metal</i> <i>Metall Zinn délabré gebürstet</i> <i>Métal brossé étain délabré</i></p>	
<p>OPM14 Metallo cromo nero lucido <i>Shiny black chrome metal</i> <i>Metall schwarz glänzend verchromt</i> <i>Métal chromé noir brillant</i></p>		<p>OPM20 Metallo spazzolato ottone Délabré <i>Délabré brass brushed metal</i> <i>Metall Messing délabré gebürstet</i> <i>Métal brossé laiton délabré</i></p>	
<p>OPM15 Metallo spazzolato oro antico <i>Brushed antique gold metal</i> <i>Metall Antik gold gebürstet</i> <i>Métal brossé or antique</i></p>		<p>OPM21 Metallo verniciato bronzo scuro <i>Dark bronze painted metal</i> <i>Metall dunkelbronze lackiert</i> <i>Métal laqué bronze foncé</i></p>	
<p>OPM16 Metallo cromo ottone lucido <i>Shiny brass chrome metal</i> <i>Metall Messing glänzend verchromt</i> <i>Métal chromé laiton brillant</i></p>		<p>OPM22 Metallo verniciato prosecco <i>Prosecco painted metal</i> <i>Metall Prosecco lackiert</i> <i>Métal laqué Prosecco</i></p>	
<p>OPM17 Metallo bronzo <i>Bronze metal</i> <i>Metall Bronz</i> <i>Métal bronze</i></p>		<p>OPM23 Metallo verniciato tabacco <i>Tobacco painted metal</i> <i>Metall Tabak lackiert</i> <i>Métal laqué tabac</i></p>	

FINITURE MARMI E PIETRE

MARBLE AND STONE FINISHES

OPP1

Marmo Carrara bianco
Carrara white marble
Marmor Carrara weiss
Marbre blanc Carrara



OPP10

Marmo Perfetto brown
Perfetto brown marble
Marmor Perfetto braun
Marbre brun Perfetto

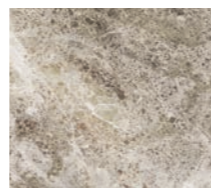

OPP2

Marmo nero Marquinia
Marquinia black marble
Marmor Marquinia schwarz
Marbre noir Marquinia

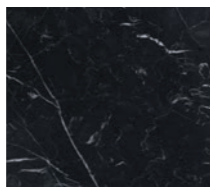

OPP11

Marmo Grey Stone
Grey Stone marble
Marmor Grey Stone
Marbre Grey Stone

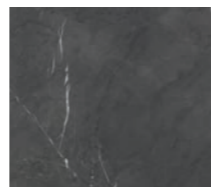

OPP3

Marmo Emperador marrone
Emperador brown marble
Marmor Emperador braun
Marbre brun Emperador

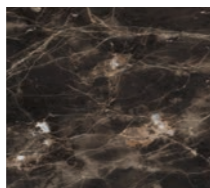

OPP12

Marmo Verde Guatemala
Guatemala green marble
Marmor Guatemala grün
Marbre vert Guatemala

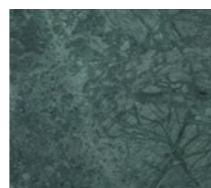

OPP7

Marmo Calacatta oro
Calacatta gold marble
Marmor Calacatta gold
Marbre Calacatta or



OPP13

Marmo Velvet brown
Velvet brown marble
Marmor Velvet brown
Marbre Velvet brown



OPP9

Marmo Black and gold
Black and gold marble
Marmor Black and gold
Marbre Black and gold

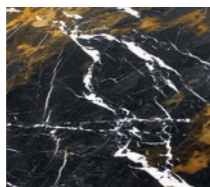

OPP14

Marmo Amani Bronze
Amani Bronze marble
Marmor Amani Bronze
Marbre Amani Bronze



OPP15

Marmo Bianco Covelano
Covelano white marble
Marmor Covelano weiss
Marbre blanc Covelano



OPP4

Pietra Serena grigia
Grey Serena stone
Grauer Serena Stein
Pierre grise Serena



OPP16

Marmo Sahara nero
Sahara noir marble
Marmor Sahara noir
Marbre Sahara noir

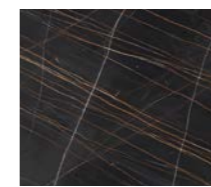

OPP5

Pietra di Brera beige
Beige Brera stone
Beige Brera Stein
Pierre beige Brera



OPP17

Marmo Port Laurent
Port Laurent marble
Marmor Port Laurent
Marbre Port Laurent

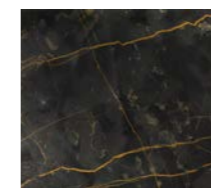

OPP20







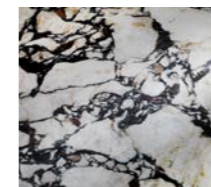

Marmo Arabescato grigio orobico
Arabescato orobico grey marble
Marmor arabescato orobico grau
Marbre arabescato orobico gris

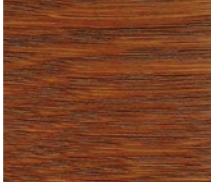

OPP21

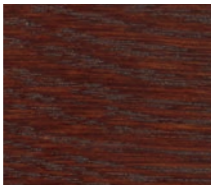
Marmo Calacatta viola
Calacatta violet marble
Marmor Calacatta violett
Marbre Calacatta violet

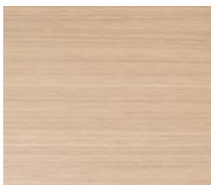
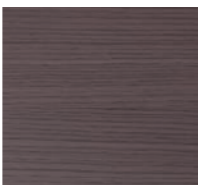

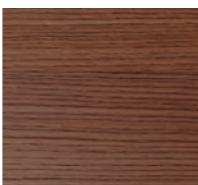
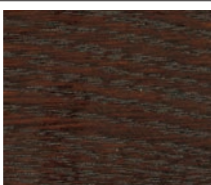
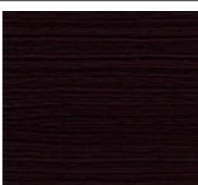
<p>OPR1 Rovere tinto ciliegio <i>Cherry stained oak</i> <i>Eiche Kirschbaum gebeizt</i> <i>Chêne teinté merisier</i></p> 	<p>OPR8 Rovere tinto tabacco <i>Tobacco stained oak</i> <i>Eiche tabak gebeizt</i> <i>Chêne teinté tabac</i></p> 
<p>OPR2 Rovere tinto wengé <i>Wengé stained oak</i> <i>Eiche Wenge gebeizt</i> <i>Chêne teinté wengé</i></p> 	<p>OPR9 Rovere tinto grigio tortora <i>Grey taupe stained oak</i> <i>Eiche beige-grau gebeizt</i> <i>Chêne teinté taupe</i></p> 
<p>OPR3 Rovere tinto noce <i>Walnut stained oak</i> <i>Eiche Nussbaum gebeizt</i> <i>Chêne teinté noyer</i></p> 	<p>OPR10 Rovere sbiancato <i>Whitened oak</i> <i>Eiche gebleicht</i> <i>Chêne blanchi</i></p> 
<p>OPR4 Rovere tinto naturale <i>Natural oak</i> <i>Eiche natur farblos lackiert</i> <i>Chêne naturel</i></p> 	<p>OPR11 Rovere tinto antracite <i>Charcoal stained oak</i> <i>Eiche Anthrazit gebeizt</i> <i>Chêne teinté anthracite</i></p> 
<p>OPR5 Rovere tinto nero <i>Black stained oak</i> <i>Eiche schwarz gebeizt</i> <i>Chêne teinté noir</i></p> 	<p>OPR12 Rovere tinto mogano <i>Mahogany stained oak</i> <i>Eiche mahagonifarbig gebeizt</i> <i>Chêne teinté acajou</i></p> 
<p>OPR6 Rovere tinto ciliegio Milano <i>Cherry Milano stained oak</i> <i>Eiche Kirschbaum Milano gebeizt</i> <i>Chêne teinté merisier Milano</i></p> 	<p>OPR15 Rovere tinto moka opaco <i>Moka matt stained oak</i> <i>Eiche moka matt gebeizt</i> <i>Chêne teinté moka mat</i></p> 

<p>OPV1 Vetro trasparente <i>Transparent glass</i> <i>Klarglas</i> <i>Verre transparent</i></p> 	<p>OPV7 Vetro retroverniciato nei colori RAL Classic <i>Glass back-painted in the RAL Classic colours</i> <i>Von hinten lackiertes Glas in den RAL Classic Farben</i> <i>Verre laqué de dessous dans les couleurs RAL Classic</i></p> <p>Colori RAL standard RAL standard colours</p>
<p>OPV2 Vetro satinato <i>Frosted glass</i> <i>Mattglas</i> <i>Verre dépoli</i></p> 	<p>OPV9 Vetro bronzato retroverniciato cromo <i>Chrome back-painted bronze glass</i> <i>Von hinten chromlackiertes Bronzenglas</i> <i>Verre bronzé laqué de dessous chrome</i></p> 
<p>OPV3 Vetro retroverniciato RAL 9016 bianco traffico <i>RAL 9016 traffic white back-painted glass</i> <i>RAL 9016 verkehrsweiß von hinten lackiertes Glas</i> <i>Verre laqué de dessous RAL 9016 blanc signalisation</i></p> 	<p>OPV10 Vetro grigio retroverniciato cromo <i>Chrome back-painted grey glass</i> <i>Von hinten chromlackiertes Grauglas</i> <i>Verre gris laqué de dessous chrome</i></p> 
<p>OPV4 Vetro retroverniciato RAL 9017 nero traffico <i>RAL 9017 traffic black back-painted glass</i> <i>RAL 9017 verkehrsschwarz von hinten lackiertes Glas</i> <i>Verre laqué de dessous RAL 9017 noir signalisation</i></p> 	<p>OPV12 Vetro bronzato trasparente <i>Transparent bronze glass</i> <i>Klarglas bronze</i> <i>Verre transparent bronzé</i></p> 
<p>OPV5 Vetro retroverniciato RAL 7044 grigio seta <i>RAL 7044 silk grey back-painted glass</i> <i>RAL 7044 seidengrau von hinten lackiertes Glas</i> <i>Verre laqué de dessous RAL 7044 gris soie</i></p> 	<p>OPV13 Vetro grigio trasparente <i>Transparent grey glass</i> <i>Klarglas grau</i> <i>Verre transparent gris</i></p> 
<p>OPV6 Vetro retroverniciato RAL 1019 beige grigiastro <i>RAL 1019 grey beige back-painted glass</i> <i>RAL 1019 graubeige von hinten lackiertes Glas</i> <i>Verre laqué de dessous RAL 1019 beige gris</i></p> 	

marelli

**NEW
COLLECTION
2023**

SCHEDE TECNICHE
TECHNICAL INFORMATION

Tavoli
Tables



7ART201
Top marmo/Marble top
7ART211
Top vetro/Glass top
ø50 H50

7ART202
Top marmo/Marble top
7ART212
Top vetro/Glass top
ø60 H40

7ART204
Top marmo/Marble top
7ART214
Top vetro/Glass top
ø100 H30

7ART203
Top marmo/Marble top
7ART213
Top vetro/Glass top
ø120 H30



Finiture
Finishes

Top in marmo
Marble top



Code
White Carrara marble **OPP1** Black Marquina marble **OPP2** Brown Emperador marble **OPP3** Grey Serena stone **OPP4** Beige Brera stone **OPP5** Calacatta gold marble **OPP7** Black and gold marble **OPP9** Perfetto brown marble **OPP10** Grey Stone marble **OPP11** Guatemala green marble **OPP12**

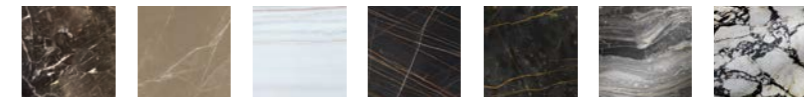

Code
Velvet brown marble **OPP13** Amani Bronze marble **OPP14** Covelano white marble **OPP15** Sahara noir marble **OPP16** Port Laurent marble **OPP17** Arabescato orobico grey marble **OPP20** Calacatta violet marble **OPP21**

Top in Gres Porcellanato
Porcelain Stoneware Top



Code
Nero Marquina **OPG2** Calacatta Royal **OPG4**

Top in vetro
Glass top



Code
RAL 9016 traffic white back-painted glass **OPV3** RAL 9017 traffic black back-painted glass **OPV4** RAL 7044 silk grey back-painted glass **OPV5** RAL 1019 grey beige back-painted glass **OPV6** Chrome back-painted bronze glass **OPV9** Chrome back-painted grey glass **OPV10**

Base in metallo
Metal Base



Code
Brushed matt chrome metal **OPM2** Brushed matt dark grey metal **OPM3** RAL 9017 black painted metal **OPM6** RAL 9016 white painted metal **OPM7** Classic bronze painted metal **OPM9** Golden beach painted metal **OPM10** Gold pearl painted metal **OPM11** Brushed copper metal **OPM12**



Code
Brushed antique brass metal **OPM13** Brushed antique gold metal **OPM15** Anodic bronze metal **OPM18** Delabre brass brushed metal **OPM20** Dark bronze painted metal **OPM21** Prosecco painted metal **OPM22** Tobacco painted metal **OPM23**

Struttura in tubolare di metallo ricoperto con schiuma di poliuretano a freddo ignifugo, classe 1IM, rivestito con una fodera in fibra acrilica. Cuscino di seduta in poliuretano espanso con densità 40 kg/m³ (5,9 KPA), rivestito in fibra acrilica.
Il rivestimento è sempre fisso.

Structure en métal tubulaire recouvert de mousse à froid ignifuge classe 1IM, recouverte d'une housse en fibre acrylique. Coussin d'assise en mousse de polyuréthane avec une densité de 40 kg/m³ (5,9 kPa), recouverte de fibre acrylique.
Le revêtement est toujours fixe.

Metal tube structure upholstered with cold injected fire retardant polyurethane foam class 1IM, covered with acrylic fibre. Seat cushion in polyurethane foam with density 40 kg/m³ (5,9 KPA), lined with acrylic fibre.
Fixed covers.

Каркас выполнен из профильной металлической трубы, покрытой слоем огнестойкого пенополиуретана холодного формования, класс 1 IM, и помещенной в чехол из акрилового волокна. Наполнение подушки сиденья выполнено из вспененного полиуретана плотностью 40 кг/м³ (5,9 кПа), помещенного в чехол из акрилового волокна. Обивка только несъемная.

Struktur der Sitzschale in Metall überschäumt mit Polyurethan-Kaltschaumstoff, Feuerwiderstandsklasse 1IM, mit Acrylfaser ummantelt. Sitzkissen aus Polyurethan-Schaumstoff mit Dichte 40 Kg/m³ (5,9 KPA), mit Acrylfaser ummantelt.
Bezüge immer fix, nicht abziehbar.

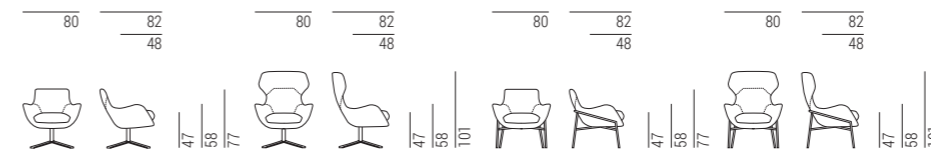

Poltrone
Armchairs



9BRE101
L80 P82 H77
Swivel metal base



9BRE102
L80 P82 H77
Wood base



9BRE103
L80 P82 H77
Metal base



9BRE104
L80 P82 H101
Swivel metal base



9BRE105
L80 P82 H101
Wood base



9BRE106
L80 P82 H101
Metal base

Finiture
Finishes

Base in metallo
per 9BRE103 e 9BRE106
Metal base
for 9BRE103 and 9BRE106

Code



Shiny chrome metal **OPM1** | Brushed matt chrome metal **OPM2** | Brushed matt dark grey metal **OPM3** | RAL 9017 black painted metal **OPM6** | RAL 9016 white painted metal **OPM7** | Classic bronze painted metal **OPM9** | Golden beach painted metal **OPM10** | Gold pearl painted metal **OPM11** | Brushed copper metal **OPM12** | Brushed antique brass metal **OPM13**

Code



Shiny black chrome metal **OPM14** | Brushed antique gold metal **OPM15** | Shiny brass chrome metal **OPM16** | Bronze metal **OPM17** | Anodized bronze metal **OPM18** | Dark bronze painted metal **OPM21** | Prosecco painted metal **OPM22** | Tobacco painted metal **OPM23**

Base in legno
Wooden base

Code



Cherry stained oak **OPR1** | Wengé stained oak **OPR2** | Walnut stained oak **OPR3** | Natural oak **OPR4** | Black stained oak **OPR5** | Cherry Milano stained oak **OPR6**

Code



Tobacco stained oak **OPR8** | Grey taupe stained oak **OPR9** | Whitened oak **OPR10** | Charcoal stained oak **OPR11** | Mahogany stained oak **OPR12** | Moka matt stained oak **OPR15**

Base girevole in metallo
per 9BRE101 e 9BRE104
Swivel metal base
for 9BRE101 and 9BRE104

Code



RAL 9017 black painted metal **OPM6** | Classic bronze painted metal **OPM9** | Golden beach painted metal **OPM10** | Gold pearl painted metal **OPM11** | Brushed antique gold metal **OPM15** | Anodized bronze metal **OPM18** | Dark bronze painted metal **OPM21**

Struttura in tubolare di metallo ricoperto con schiuma di poliuretano a freddo ignifugo, classe 11M. Cuscino di seduta con struttura in Baydur® 80IK28/DO con imbottitura in poliuretano espanso con densità 40 kg/m³ (5,9 KPA), rivestito in fibra acrilica. Il rivestimento è sempre fisso. Il basamento girevole è in metallo a 4 razze.
Basamento girevole in metallo disponibile in due versioni.

Structure en métal tubulaire recouvert de mousse à froid ignifuge classe 11M. Coussin d'assise avec structure en Baydur® 80IK28/DO, rembourré en mousse polyuréthane d'une densité de 40 kg/m³ (5,9 KPA), recouverte de fibre acrylique. Le revêtement est toujours fixe. Base pivotante en métal à 4 pieds.
Base pivotante en métal disponible en deux versions.

Metal tube structure upholstered with cold injected fire retardant polyurethane foam class 11M. Seat cushion with structure in Baydur® 80IK28/DO upholstered with polyurethane foam with density of 40 kg/m³ (5,9 KPA), covered with acrylic fibre. Covers are always fixed. The metal swivel base is a 4-star base.
Metal swivel base available in two versions.

Каркас из металлического профиля, покрытого слоем огнеупорного пенополиуретана холодного отверждения класса 11M. Подушка сиденья имеет основу из Baydur® 80IK28/DO и наполнение из вспененного полиуретана плотностью 40 кг/м³ (5,9 Кпа), обернутого в акриловое волокно. Обивка подушки несъемная. Вращающееся металлическое основание имеет 4 опоры.

Struktur der Sitzschale in Metall überschäumt mit Polyurethan-Kaltschaumstoff, Feuerwiderstandsklasse 11M. Sitzkissen mit Gestell in Baydur® 80IK28/DO, gepolstert mit Polyurethanschaumstoff mit Dichte 40 Kg/m³ (5,9 KPA), mit Acrylfaser ummantelt. Bezüge immer fix, nicht abziehbar. Das Drehgestell ist in Metall, mit 4-Fusskreuz mit Standsäule.
Das Drehgestell ist in Metall, in zwei Versionen erhältlich.

Baydur® - полимерный материал, производимый концерном Bayer.
Металлическая поворотная основа доступна в двух версиях.



Poltrone
Armchairs



9CHI103
L58 P53 H77
Poltroncina girevole con base in metallo
Swivel armchair with metal base



9CHI104
L58 P53 H77
Poltroncina con base in metallo
Armchair with metal base



9CHI105
L58 P53 H77
Poltroncina con base in legno
Armchair with wooden base



9CHI106
L58 P60 H102
Sgabello
Bar stools

Basi girevoli
Swivel bases

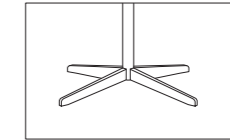

Versione A Base girevole in metallo a 4 razze
Version A Swivel 4-star metal base

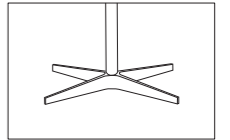

Versione B Base girevole in metallo a 4 razze
Version B Swivel 4-star metal base

Finiture
Finishes

9CHI103 Base girevole in metallo A Swivel metal base A								
Code	Brushed matt chrome metal OPM2	Brushed matt dark grey metal OPM3	RAL 9017 black painted metal OPM6	RAL 9016 white painted metal OPM7	Classic bronze painted metal OPM9	Golden beach painted metal OPM10	Gold pearl painted metal OPM11	Brushed copper metal OPM12
Code								
Code	Brushed antique brass metal OPM13	Shiny black chrome metal OPM14	Brushed antique gold metal OPM15	Anodyc Bronze painted metal OPM18	Dark bronze painted metal OPM21	Prosecco painted metal OPM22	Tobacco painted metal OPM23	
9CHI103 Base girevole in metallo B Swivel metal base B								
Code	Shiny chrome metal OPM1	Brushed matt chrome metal OPM2	RAL 9017 black painted metal OPM6	Classic bronze painted metal OPM9	Dark bronze painted metal OPM21			

9CHI104 9CHI106 base in metallo metal base								
Code	Brushed matt chrome metal OPM2	Brushed matt dark grey metal OPM3	RAL 9017 black painted metal OPM6	RAL 9016 white painted metal OPM7	Classic bronze painted metal OPM9	Golden beach painted metal OPM10	Gold pearl painted metal OPM11	Brushed copper metal OPM12
Code								
Code	Brushed antique brass metal OPM13	Brushed antique gold metal OPM15	Anodyc bronze metal OPM18	Delabre pewter brushed metal OPM19	Delabre brass brushed metal OPM20	Dark bronze painted metal OPM21	Prosecco painted metal OPM22	Tobacco painted metal OPM23
9CHI105 Base in legno Wooden base								
Code	Cherry stained oak OPR1	Wengé stained oak OPR2	Walnut stained oak OPR3	Natural oak OPR4	Black stained oak OPR5	Cherry Milano stained oak OPR6		
Code								
Code	Tobacco stained oak OPR8	Grey taupe stained oak OPR9	Whitened oak OPR10	Charcoal stained oak OPR11	Mahogany stained oak OPR12	Moka matt stained oak OPR15		

Tavoli
Tables

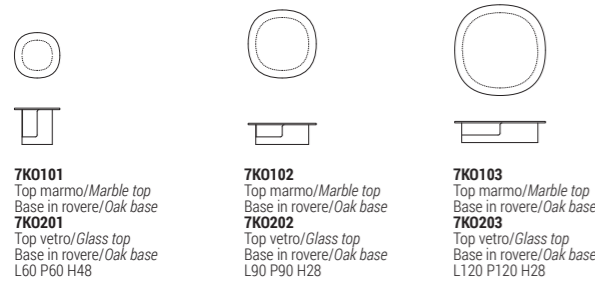

7K0101
Top marmo/Marble top
Base in rovere/Oak base
7K0201
Top vetro/Glass top
Base in rovere/Oak base
L60 P60 H48

7K0102
Top marmo/Marble top
Base in rovere/Oak base
7K0202
Top vetro/Glass top
Base in rovere/Oak base
L90 P90 H28

7K0103
Top marmo/Marble top
Base in rovere/Oak base
7K0203
Top vetro/Glass top
Base in rovere/Oak base
L120 P120 H28

Finiture
Finishes

Base in metallo Metal base								
Code	OPM2	OPM3	OPM6	OPM7	OPM9	OPM10	OPM11	OPM12
Top in marmo Marble top								
Code	OPP1	OPP2	OPP3	OPP4	OPP5	OPP7	OPP9	OPP10
Top in vetro Glass top								
Code	OPV3	OPV4	OPV5	OPV6	OPV9	OPV10		

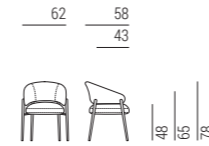

Schienale in legno multistrato di pioppo curvato imbottito con poliuretano espanso con densità 30 kg/m³. Seduta in legno multistrato di pioppo imbottito con poliuretano espanso 40 kg/m³, rivestito in dacron con cinghie elastiche intrecciate.

Dossier en bois multiplis de peuplier courbé fini de mousse de polyuréthane de densité de 30 kg/m³. Structure de l'assise en bois multiplis de peuplier finie de mousse de polyuréthane de densité de 40 kg/m³ couverte de dacron, muni de bandes élastiques entrecroisées.

Backrest made of curved multi-ply poplar wood, upholstered with polyurethane foam with density 30 kg/m³. Seat structure made of multi-ply poplar wood, upholstered with polyurethane foam with density of 40 kg/m³, covered with dacron, with interwoven elastic belts.

Для изготовления спинки используется гнутая многослойная фанера из тополя с наполнением из вспененного полиуретана плотностью 30 кг/м³. Конструкция сиденья: многослойная фанера из тополя с наполнением из вспененного полиуретана плотностью 40 кг/м³, обернутого в дакрон, в сочетании с перекрещивающимися эластичными ремнями.

Rückenlehne aus gebogenem Pappelschichtholz, gepolstert mit Polyurethan-Schaumstoff mit Dichte 30 Kg/m³. Sitzstruktur aus Pappelschichtholz, gepolstert mit Polyurethan-Schaumstoff mit Dichte 40 Kg/m³, mit Dacron ummantelt, mit geflochtenen Gummigurten.

Poltrone
Armchairs



9LIN101
L62 P58 H78
Base in metallo verniciato nelle finiture standard
Metal base in standard painted finishes

9LIN102
L62 P58 H78
Base in metallo in finiture optional
Metal base in optional finishes

Finiture
Finishes

Base e puntali in metallo Metal base and tips								
Code	OPM6	OPM7	OPM9	OPM10	OPM11	OPM15	OPM18	
Base e puntali in metallo Metal base and tips								
Code	OPM2	OPM3	OPM12	OPM13	OPM19	OPM20	OPM22	OPM23

Fusto in legno massello e legno multistrato con cinghie elastiche intrecciate.
Imbottitura della seduta in poliuretano espanso con densità 40 kg/m³ rivestito in dacron.
Imbottitura dello schienale in poliuretano espanso a quote differenziate con densità di 30 kg/m³ e 40 kg/m³, rivestito in dacron.
Rivestimento fisso.

*Carcasse en bois massif et multiplis munie de bandes élastiques entrecroisées.
Assise rembourrée en mousse de polyuréthane d'une densité de 40 kg/m³ couverte de dacron.
Dossier rembourré en mousse polyuréthane de différentes densités de 30 kg/m³ et 40 kg/m³ couverte de dacron.
Revêtement fixe.*

Frame made of solid wood and plywood with interwoven elastic belts.
Seat upholstered with polyurethane foam with density of 40 kg/m³, covered with dacron.
Back upholstered with polyurethane foam with different densities of 30 kg/m³ and 40 kg/m³, covered with dacron.
Fixed covers.

*Для производства каркаса используется массив дерева и многослойная фанера в сочетании с перекрещивающимися эластичными ремнями. Наполнение сиденья из вспененного пенополиуретан плотностью - 30 кг/м³, обернутого в дакрон.
Наполнение спинки из вспененного пенополиуретана различной степени плотности - 30 кг/м³ и 40 кг/м³, обернутого в дакрон.
Чехлы несъемные.*

Das Gestell besteht aus Massiv- und Schichtholz, mit geflochtenen Gummigurten.
Sitz gepolstert mit Polyurethan-Schaumstoff 40 Kg/m³, mit Dacron bezogen.
Rücken gepolstert mit Polyurethan-Schaumstoff in verschiedenen Dichten 30 Kg/m³ und 40 Kg/m³, mit Dacron bezogen.
Ribot ist immer festbezogen.

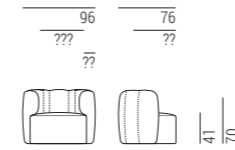

Elementi di seduta
Seat elements

Pouf
Ottomans



Fusto in legno massello e legno multistrato con cinghie elastiche intrecciate.
Imbottitura della seduta in poliuretano espanso con densità 40 kg/m³ rivestito in dacron.
Imbottitura dello schienale in poliuretano espanso a quote differenziate con densità di 30 kg/m³ e 40 kg/m³, rivestito in dacron.
Rivestimento fisso.

Carcasse en bois massif et multiplis munie de bandes élastiques entrecroisées.
Assise rembourrée en mousse de polyuréthane d'une densité de 40 kg/m³ couverte de dacron.
Dossier rembourré en mousse polyuréthane de différentes densités de 30 kg/m³ et 40 kg/m³ couverte de dacron.
Revêtement fixe.

Frame made of solid wood and plywood with interwoven elastic belts.
Seat upholstered with polyurethane foam with density of 40 kg/m³, covered with dacron.
Back upholstered with polyurethane foam with different densities of 30 kg/m³ and 40 kg/m³, covered with dacron.
Fixed covers.

Для производства каркаса используется массив дерева и многослойная фанера в сочетании с перекрещивающимися эластичными ремнями. Наполнение сиденья из вспененного пенополиуретан плотностью - 30 кг/м³, обернутого в дакрон.
Наполнение спинки из вспененного пенополиуретана различной степени плотности - 30 кг/м³ и 40 кг/м³, обернутого в дакрон.
Чехлы несъемные.

Das Gestell besteht aus Massiv- und Schichtholz, mit geflochtenen Gummigurten.
Sitz gepolstert mit Polyurethan-Schaumstoff 40 Kg/m³, mit Dacron bezogen.
Rücken gepolstert mit Polyurethan-Schaumstoff in verschiedenen Dichten 30 Kg/m³ und 40 Kg/m³, mit Dacron bezogen.
Ribot ist immer festbezogen.

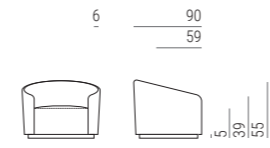

Divani
Sofas

Pouf e accessori
Ottomans and accessories



9MN101
L98 P90 H76

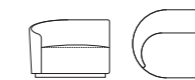

9MN206
L106 P90 H76



9MN102
Ø60 H40

Cuscino in piuma senza fascia
Feather back cushion without band



9MN201
L200 P90 H76

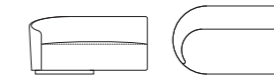

9MN207
L156 P90 H76

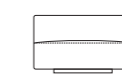

9MN210
L130 P90 H76

9CU106
L45 P45



9MN202
L250 P90 H76

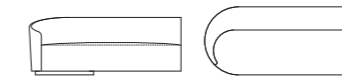

9MN208
L201 P90 H76

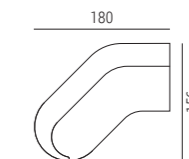

9MN205
L180 P156 H76



9MN203
L245 P120 H76

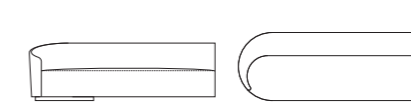

9MN209
L246 P90 H76



9MN204
L305 P120 H76

Finiture
Finishes

Base metallo
Metal base



Shiny chrome metal **OPM1** | Brushed matt chrome metal **OPM2** | Brushed matt dark grey metal **OPM3** | RAL 9017 black painted metal **OPM6** | Classic bronze painted metal **OPM9**



Golden beach painted metal **OPM10** | Gold pearl painted metal **OPM11** | Brushed copper metal **OPM12** | Brushed antique brass metal **OPM13** | Shiny black chrome metal **OPM14** | Brushed antique gold metal **OPM15** | Shiny brass chrome metal **OPM16** | Bronze metal **OPM17** | Anodized Bronze painted metal **OPM18** | Dark bronze painted metal **OPM21**

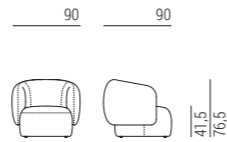

Fusto in legno massello e legno multistrato con cinghie elastiche intrecciate.
Imbottitura della seduta in poliuretano espanso con densità 40 kg/m³ rivestito in dacron.
Imbottitura dello schienale in poliuretano espanso a quote differenziate con densità di 30 kg/m³ e 40 kg/m³, rivestito in dacron.
Rivestimento fisso.

*Carcasse en bois massif et multiplis munie de bandes élastiques entrecroisées.
Assise rembourrée en mousse de polyuréthane d'une densité de 40 kg/m³ couverte de dacron.
Dossier rembourré en mousse polyuréthane de différentes densités de 30 kg/m³ et 40 kg/m³ couverte de dacron.
Revêtement fixe.*

Frame made of solid wood and plywood with interwoven elastic belts.
Seat upholstered with polyurethane foam with density of 40 kg/m³, covered with dacron.
Back upholstered with polyurethane foam with different densities of 30 kg/m³ and 40 kg/m³, covered with dacron.
Fixed covers.

*Для производства каркаса используется массив дерева и многослойная фанера в сочетании с перекрещивающимися эластичными ремнями. Наполнение сиденья из вспененного пенополиуретан плотностью - 30 кг/м³, обернутого в дакрон.
Наполнение спинки из вспененного пенополиуретана различной степени плотности - 30 кг/м³ и 40 кг/м³, обернутого в дакрон.
Чехлы несъемные.*

Das Gestell besteht aus Massiv- und Schichtholz, mit geflochtenen Gummigurten.
Sitz gepolstert mit Polyurethan-Schaumstoff 40 Kg/m³, mit Dacron bezogen.
Rücken gepolstert mit Polyurethan-Schaumstoff in verschiedenen Dichten 30 Kg/m³ und 40 Kg/m³, mit Dacron bezogen.
Ribot ist immer festbezogen.

Divani
Sofas

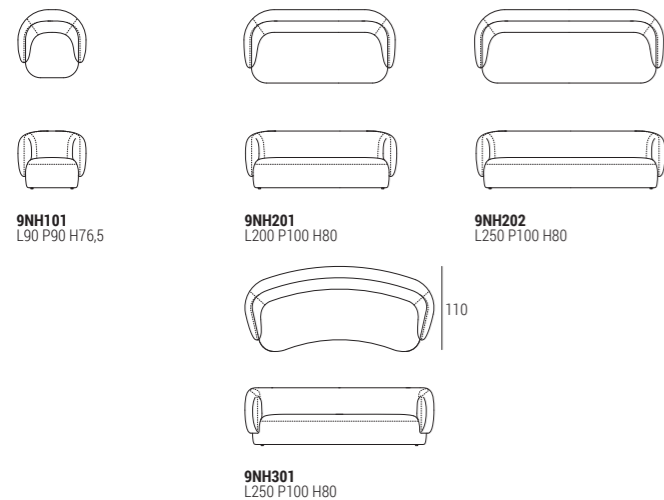

Dormeuse sinistra
Longchair left

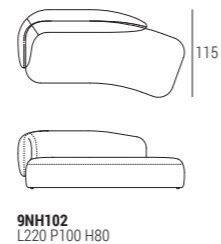

Tavoli
Dining tables

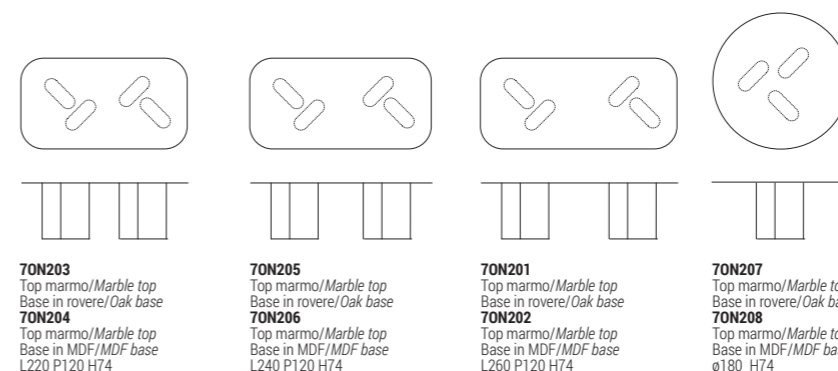







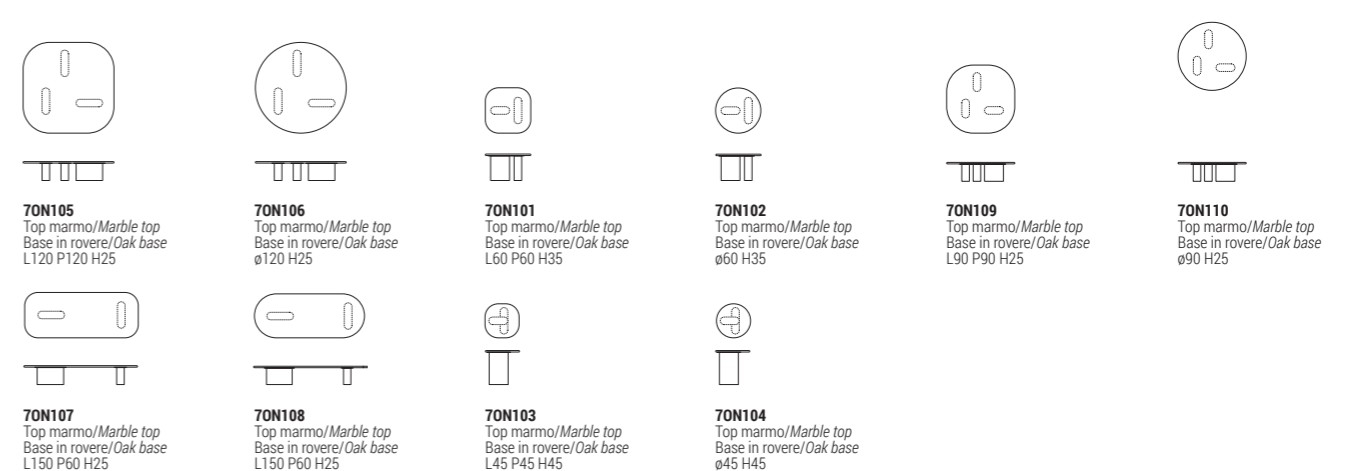

























Il tavolo da pranzo Onno è disponibile con top in marmo e base in due versioni:
- base impiallacciato rovere tinto nelle finiture rovere in collezione
- base in MDF verniciato finiture metallo o verniciato nei colori RAL Classic

*Onno dining table is available with marble top and base in two versions:
- oak veneer base stained in the oak finishes in collection
- base in MDF painted in metal finishes or painted in the RAL Classic colours*

Tavolini
Coffee tables



Finiture
Finishes

Top in marmo Marble top								
Code	White Carrara marble OPP1	Black Marquinia marble OPP2	Brown Emperador marble OPP3	Grey Serena stone OPP4	Beige Brera stone OPP5	Calacatta gold marble OPP7	Black and gold marble OPP9	Perfetto brown marble OPP10
								
Code	Grey Stone marble OPP11	Velvet brown marble OPP13	Amani Bronze marble OPP14	Covelano white marble OPP15	Sahara noir marble OPP16	Port Laurent marble OPP17	Arabescato orobico grey marble OPP20	Calacatta violet marble OPP21
Base in rovere impiallacciato Oak veneer base								
Code	Cherry stained oak OPR1	Wengé stained oak OPR2	Walnut stained oak OPR3	Natural oak OPR4	Black stained oak OPR5	Cherry Milano stained oak OPR6		
								
Code	Tobacco stained oak OPR8	Grey taupe stained oak OPR9	Whitened oak OPR10	Charcoal stained oak OPR11	Mahogany stained oak OPR12	Moka matt stained oak OPR15		
Base legno finitura metallo Wooden base with metal finishing								
Code	Brushed antique gold metal OPM15	Delabre pewter brushed metal OPM19	Delabre brass brushed metal OPM20		Base in MDF MDF base	Painted in RAL Classic colors		

Libreria
Bookshelf

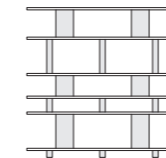





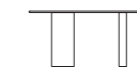











70N301
L200 P38 H198

Consolle
Console



70N302
L160 P50 H74

Finiture
Finishes

Mensole Shelves						
Code	Cherry stained oak OPR1	Wengé stained oak OPR2	Walnut stained oak OPR3	Natural oak OPR4	Black stained oak OPR5	Cherry Milano stained oak OPR6
						
Code	Tobacco stained oak OPR8	Grey taupe stained oak OPR9	Whitened oak OPR10	Charcoal stained oak OPR11	Mahogany stained oak OPR12	Moka matt stained oak OPR15
Struttura Structure						
Code	Brushed antique gold metal OPM15	Delabre pewter brushed metal OPM19	Delabre brass brushed metal OPM20	Painted in RAL Classic colors		

Schienale in legno multistrato di pioppo curvato imbottito con poliuretano espanso con densità 30 kg/m³. Seduta in legno multistrato di pioppo imbottito con poliuretano espanso 40 kg/m³, rivestito in dacron con cinghie elastiche intrecciate. Rivestimento fisso.

Dossier en bois multiplis de peuplier courbé fini de mousse de polyuréthane de densité de 30 kg/m³. Structure de l'assise en bois multiplis de peuplier finie de mousse de polyuréthane de densité de 40 kg/m³ couverte de dacron, muni de bandes élastiques entrecroisées. Revêtement fixe.

Backrest made of curved multi-ply poplar wood, upholstered with polyurethane foam with density 30 kg/m³. Seat structure made of multi-ply poplar wood, upholstered with polyurethane foam with density of 40 kg/m³, covered with dacron, with interwoven elastic belts. Fixed covers.

Для изготовления спинки используется гнутая многослойная фанера из тополя с наполнением из вспененного полиуретана плотностью 30 кг/м³. Конструкция сиденья: многослойная фанера из тополя с наполнением из вспененного полиуретана плотностью 40 кг/м³, обернутого в дакрон, в сочетании с перекрещивающимися эластичными ремнями. Обивка несъемная.

Rückenlehne aus aus gebogenem Pappelschichtholz, gepolstert mit Polyurethan-Schaumstoff mit Dichte 30 Kg/m³. Sitzstruktur aus Pappelschichtholz, gepolstert mit Polyurethan-Schaumstoff mit Dichte 40 Kg/m³, mit Dacron ummantelt, mit geflochtenen Gummigurten. Sign ist immer festbezogen.

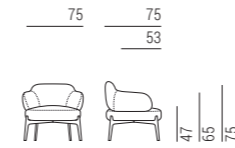

Divani
Sofas



9SI101
Poltrona girevole/Swivel armchair
L83 P75 H75



9SI112
Base in metallo/Metal base
L83 P75 H75

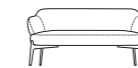

9SI211
Base in metallo/Metal base
L160 P75 H75

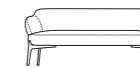

9SI212
Base in metallo/Metal base
L180 P75 H75



9SI102
Base in legno/Wood base
L83 P75 H75

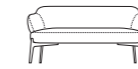

9SI201
Base in legno/Wood base
L160 P75 H75

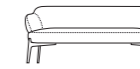

9SI202
Base in legno/Wood base
L180 P75 H75

Finiture
Finishes

Base in metallo
+ base in metallo girevole
Metal base
+ swivel metal base

Code



Shiny chrome metal **OPM1** | Brushed matt chrome metal **OPM2** | Brushed matt dark grey metal **OPM3** | RAL 9017 black painted metal **OPM6** | RAL 9016 white painted metal **OPM7** | Classic bronze painted metal **OPM9** | Golden beach painted metal **OPM10** | Gold pearl painted metal **OPM11**

Code



Brushed copper metal **OPM12** | Brushed antique brass metal **OPM13** | Shiny black chrome metal **OPM14** | Brushed antique gold metal **OPM15** | Shiny brass chrome metal **OPM16** | Bronze metal **OPM17** | Anodyc Bronze painted metal **OPM18** | Dark bronze painted metal **OPM21**

Base in legno
Wooden base

Code



Cherry stained oak **OPR1** | Wengé stained oak **OPR2** | Walnut stained oak **OPR3** | Natural oak **OPR4** | Black stained oak **OPR5** | Cherry Milano stained oak **OPR6**

Code

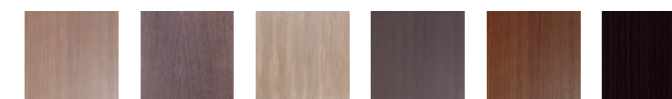

Tobacco stained oak **OPR8** | Grey taupe stained oak **OPR9** | Whitened oak **OPR10** | Charcoal stained oak **OPR11** | Mahogany stained oak **OPR12** | Moka matt stained oak **OPR15**

Madia
Sideboard

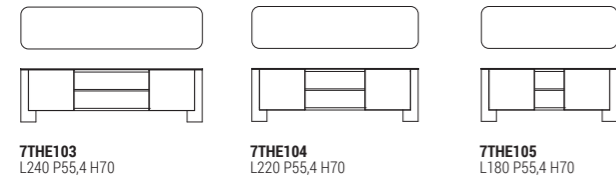

7THE103
L240 P55,4 H70

7THE104
L220 P55,4 H70

7THE105
L180 P55,4 H70

Specchi
Mirror

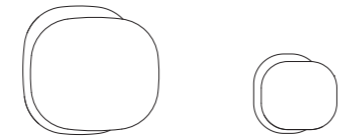

7THE102
L180 P4,5 H170

7THE101
L110 P4,5 H105

Fusto in legno massello e legno multistrato con cinghie elastiche intrecciate.
Imbottitura in poliuretano espanso con densità 40 Kg/m³ rivestito in dacron.
Seduta e schienale in poliuretano espanso con densità di 30 Kg/m³, rivestito in dacron.
Cuscini di schienale in piuma.
Rivestimento sfoderabile in tessuto, non sfoderabile in pelle e finta pelle.
Kit letto non disponibile.

Frame made of solid wood and multi-ply wood with interwoven elastic straps, upholstered with polyurethane foam with density of 40 Kg/m³, covered with dacron.
Seat and back in polyurethane foam with density of 30 Kg/m³, covered with dacron.
Feather back cushions.
Removable fabric covers, fixed leather and artificial leather covers.
Sofa-bed is not available.

Das Gestell besteht aus Massiv- und Schichtholz, mit geflochtenen Gummigurten, gepolstert mit Polyurethan-Schaumstoff 40 Kg/m³, mit Dacron ummantelt.
Sitz und Rücken bestehen aus Polyurethan-Schaumstoff 30 Kg/m³, mit Dacron ummantelt.
Rückenkissen in Daune.
Abziehbare Stoffbezüge, feste Leder- und Kunstlederbezüge.
Als Bettsofa nicht verfügbar.

Carcasse en bois massif et multiplis muni de bandes élastiques entrecroisées et finie de mousse de polyuréthane d'une densité de 40 kg/m³ couverte de dacron.
Assise et dossier en mousse de polyuréthane d'une densité de 30 kg/m³, couverte de dacron.
Coussins de dossier en plumes.
Revêtement déhoussable en tissu, revêtement fixe en cuir et similcuir.
Pas disponible en canapé-lit.

Каркас из массива дерева и фанеры с переплетенными эластичными ремнями.
Набивка из пенополиуретана плотностью 40 кг/м³, покрытая дакроном.
Сиденье и спинка из пенополиуретана плотностью 30 кг/м³, покрыты дакроном.
Подушки спинки из пера.
Съемный чехол из ткани, несъемный чехол из кожи и искусственной кожи.
Комплект постели не поставляется.

Finiture
Finishes

Struttura madia Sideboard structure						
Code	Cherry stained oak OPR1	Wengé stained oak OPR2	Walnut stained oak OPR3	Natural oak OPR4	Black stained oak OPR5	Cherry Milano stained oak OPR6
Code	Tobacco stained oak OPR8	Grey taupe stained oak OPR9	Whitened oak OPR10	Charcoal stained oak OPR11	Mahogany stained oak OPR12	Moka matt stained oak OPR15
Maniglie Handles						
Code	Brushed matt chrome metal OPM2	Brushed matt dark grey metal OPM3	RAL 9017 traffic black painted metal OPM6	RAL 9016 white painted metal OPM7	Classic bronze painted metal OPM9	Golden beach painted metal OPM10
Code	Gold pearl painted metal OPM11	Brushed copper metal OPM12	Brushed antique brass metal OPM13	Brushed antique gold metal OPM15	Anodyc bronze metal OPM18	Delabre pewter brushed metal OPM19
Code	Delabre brass brushed metal OPM20	Dark bronze painted metal OPM21	Prosecco painted metal OPM22	Tobacco painted metal OPM23		

Finiture
Finishes



MDF painted in RAL Classic colours matt
Bronze mirror

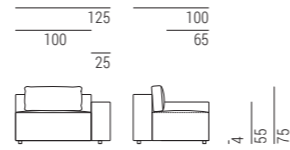

Elementi di seduta
Seat elements



Pouf
Ottomans



Elementi componibili
Modular elements

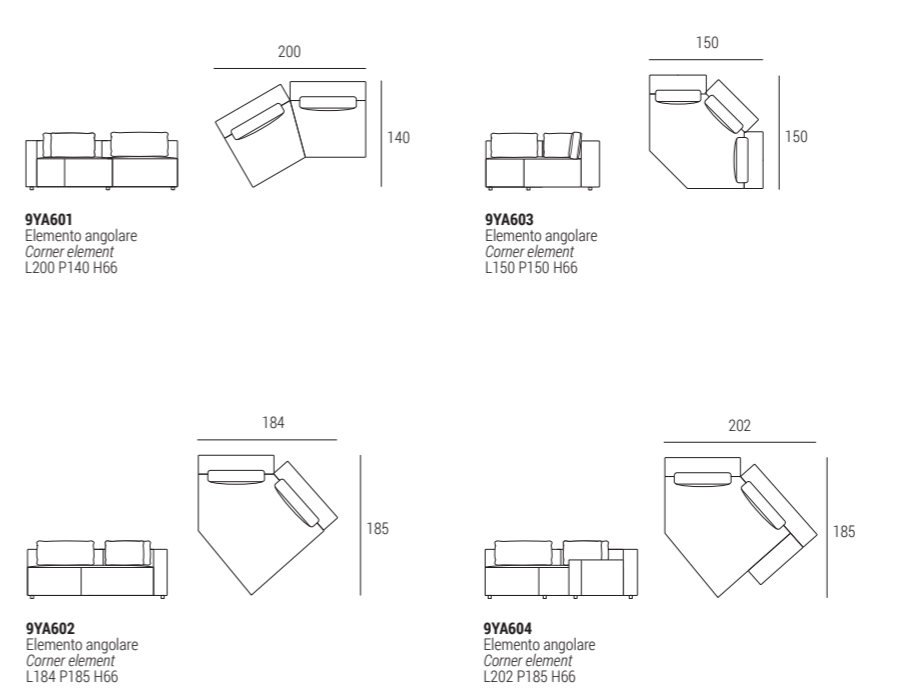

Tavolini
Tables

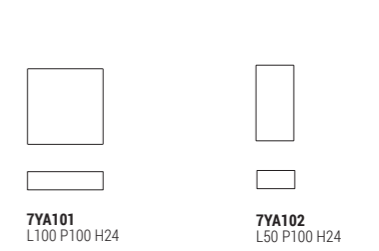

graphic
Matteo Paoloni

stylist
Morena Colombo

set design
Studio Tronconi architetti
Gianluca Tronconi e Giacomo Grassi

photo
IKB Studio

all rights reserved © 2023

marelli

Giulio Marelli Italia SpA

Via Indipendenza 159 20821 Meda (MB) Italia T ++39 0362 342116
info@giuliomarelli.com www.giuliomarelli.com

marelli

Giulio Marelli Italia SpA

Via Indipendenza 159 20821 Meda (MB) Italia T ++39 0362 342116
info@giuliomarelli.com www.giuliomarelli.com