

PRODUCT INFORMATION MODEL OD1037 LETTINO

© 2011 KURT BEIER & KATI QUINGER



*For general informations please refer to the information about outdoor furniture!
Bullfrog recommends the suitable waterproofed protective covers for outdoor furnitures.*



Comfortable sitting due to functional backrest and adjustable footrest



Practical intermediate table



Lower frame with castors, Optionally stainless steel square pipe or metal, matt black fine stucture powder-coated.

OD LETTINO: FLOAT ON A CLOUD. OUTDOOR AND GARDEN LOUNGER WITH SOFT UPHOLSTERY ON A LIGHT, HIGH-QUALITY STAINLESS STEEL BASE FRAME. HEAD AND FOOT SECTION CAN BE ADJUSTED TO HORIZONTAL POSITION IN SEVERAL STEPS. DIFFERENT SEAM OPTIONS AVAILABLE.



Base frame with castors: Optionally stainless steel square pipe or metal, matt black fine sturcture powder-coated.

Castor: Ø 12,5 cm with rubber tread and Stainless steel cover.

Intermediate table: metal, matt black fine sturcture powder-coated.

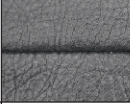
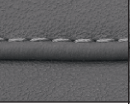

Processing options of main seam / decorative seam

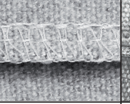
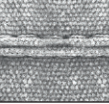
	Plain seam	Lap seam	KR* (zipper piping) extra charge	Overcast seam extra charge	Piping
					
Outdoor fabric	x				x
Outdoor leather	x				x

*Zipper piping: optionally in the colours black, red, nature or light grey.

Outdoor innercover

Additional protection against moisture penetration is provided by an inner cover made of waterproof fabric. The inner cover can be selected for the respective model at an extra charge.

Please specify when ordering.

03.11.2021

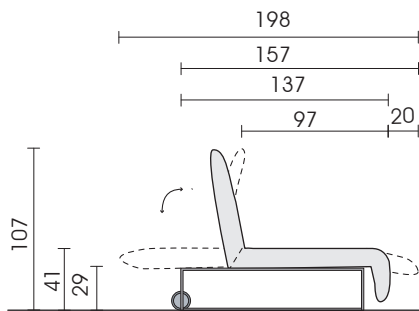

Side view

☐ = Label

Lounger

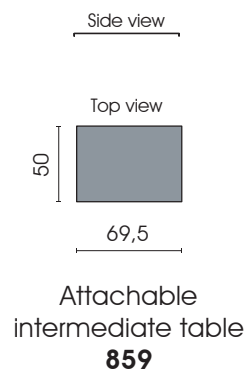
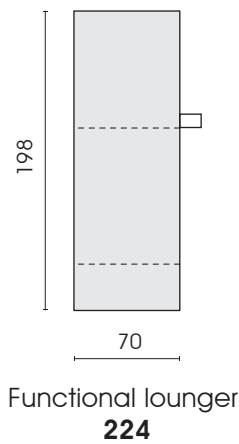

Protective cover (Waterproof):

Protective cover for type 224: SH224

Each piece of furniture is handmade and unique. Deviations to the listed measurements may be caused by:
1. different upholstery materials (fabric, leather), 2. processing of ticking mats, 3. the pressure to combine individual parts, etc.
The seat comfort of a sofa type with larger seat depth usually differs from one with lower depth.