

Collections23







*"Eri qui quando sei arrivato,
resterai qui quando te ne andrai"*

*"You were here when you came,
and you will stay here when you leave"*

Si dice che l'uomo moderno sia colui che è capace di dialogare con le nuvole tenendo i piedi ben piantati per terra.

Vittorio Marelli è sempre stato così.

Fantasia e concretezza, che insieme alla passione ed alla perseveranza, diventano la miscela magica capace di prendere per mano un'idea e condurla al suo compimento.

Una vita dedicata ad immaginare e produrre divani e poltrone. Un lavoro lungo mezzo secolo, guidato da un solo dogma: qualità, bellezza e cultura, sempre.

E' così anche per il suo ultimo progetto che inaugura questo catalogo.

Seguire la luce del suo sguardo, appassionato e fiero, sarà il modo per dire Grazie.

They say a modern man has his head in the clouds and his feet firmly on the ground.

Vittorio Marelli was always like this.

A fusion of imagination and practicality, when combined with passion and persistence, generates the magnetic force capable of grasping an idea and guiding it toward its realization.

A life dedicated to imagining and crafting sofas and armchairs. A labor of love that has lasted for half a century, defined and directed by a steadfast principle: excellence, aesthetics, and culture, without exception.

This is also true of his last project, which inaugurates this new catalog.

Following the light of his gaze, passionate and proud, will be the way to say Thank you.

Scegliere un divano e una poltrona Marac è come una luce accesa dietro la porta: ti dice che sei a casa. E stai bene.

Choosing a sofa or an armchair made by Marac is like a light on your door: it shows that you are home. And feel well.

Auf einem Marac Sofa oder einem Sessel zu sitzen gibt Dir das Gefühl zu Hause zu sein.

Sofas



Vittorio 6



Cloud 18



Mistral 28



Aland 38

Armchairs



Aland 50



Bumper 52



Bumper Lounge 54



Dover 56

Complements



Island 58

Vittorio

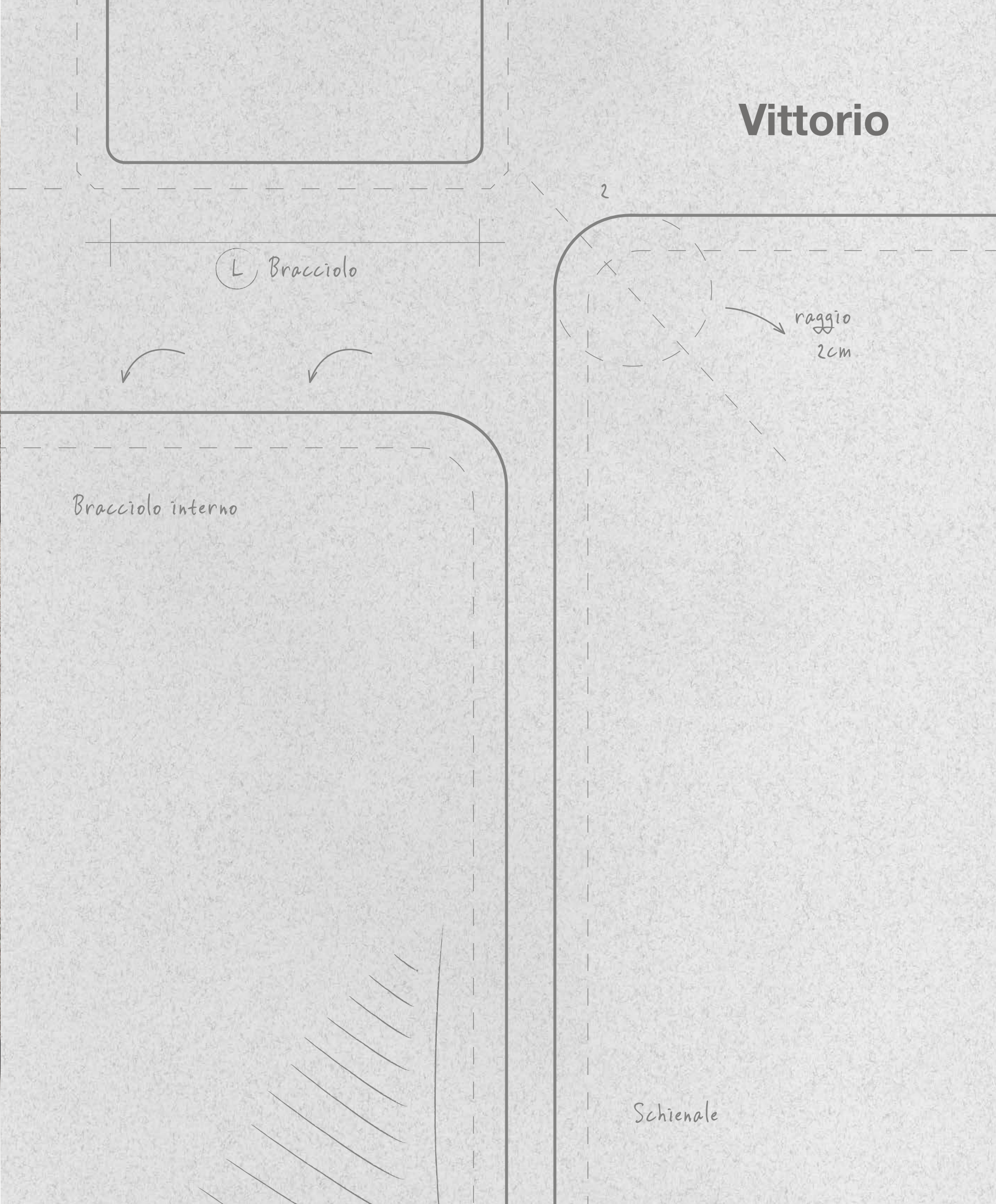



VITTORIO | Left element 190 cm and Long Corner 190 cm

Fabric Thuy color 4 / Tortora - Small cushions Fabric Dhogar color 14 / Zolfo

LESLIE | Swivel Armchair 72cm, Fabric Dhogar color 14 / Zolfo

ISLAND | Coffee Table, 130x100x20h cm, matt lacquered finish color Muschio

BOULEVARD | Coffee Table, 90x90x32h cm, matt lacquered finish color Pepe and Ø30x46h cm Dark Grey Stone finish

Console, 150x35x42h cm, Dark Grey Stone finish



VITTORIO | Left element 210 cm and Chaise Longue 210 cm
Fabric Thuy color 4 / Tortora - Small cushions Leather Nabuk color Conchiglia
LESLIE | Swivel Armchair 72cm, Fabric Dhogar color 14 / Zolfo
LAIN | Pouf, 100x75x38h cm, Fabric Dhogar color 14 / Zolfo
BOULEVARD | Console 150x35x42h cm Candoglia Rock finish
MIK | Coffee Table 32x32x35h and 45h cm, matt lacquered finish color Muschio





VITTORIO | Left element 210 cm and Chaise longue 190 cm
Fabric Thuy color 4 / Tortora – Small cushions Fabric Dhogar color 14 / Zolfo
LESLIE | Swivel Armchair, Fabric Dhogar color 14 / Zolfo
BOULEVARD | Coffee Table, ø30 x 46h cm matt lacquered finish color Pepe
ISLAND | Coffee Table, 130x100x20 cm, matt lacquered finish color Muschio

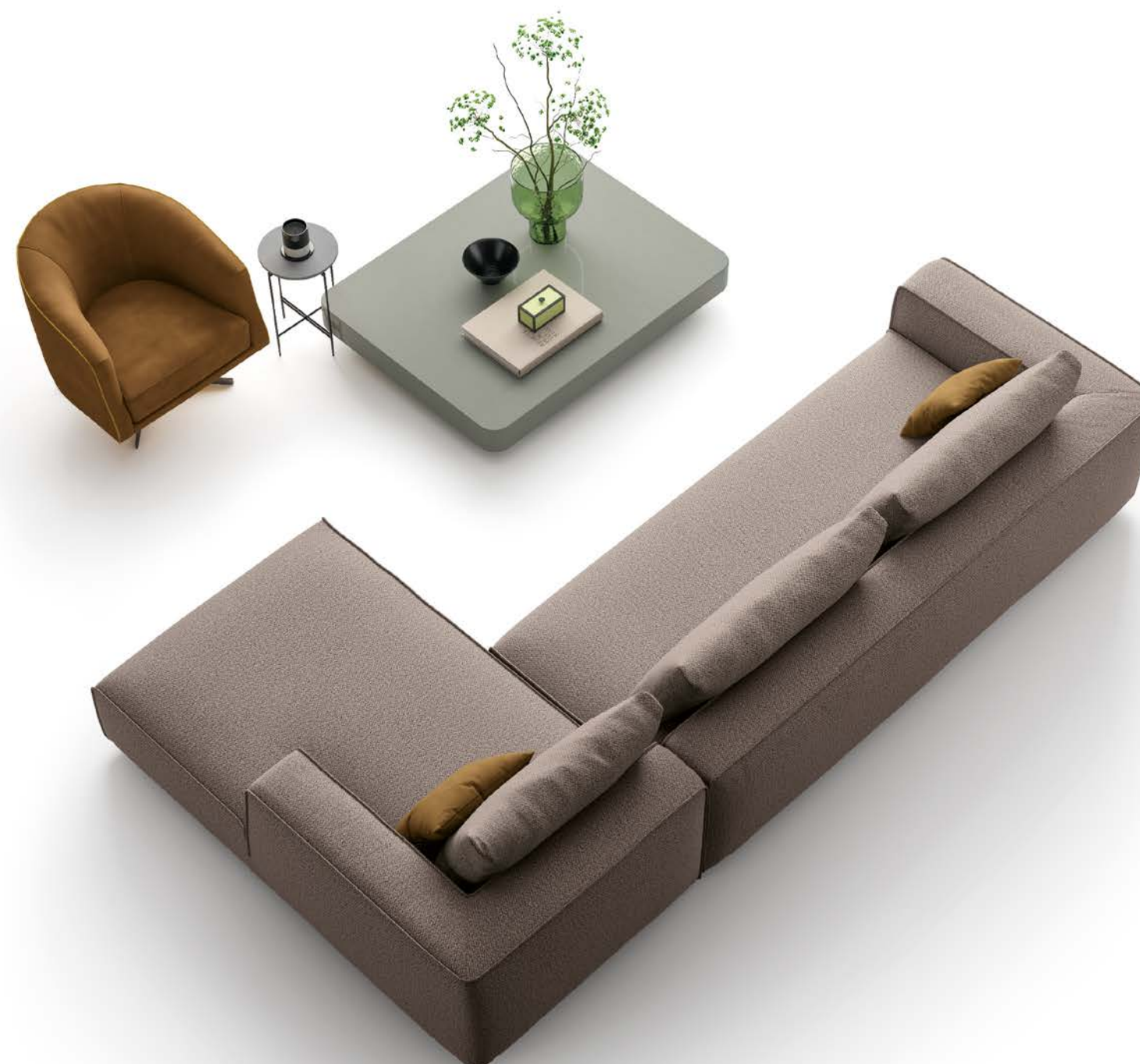

VITTORIO | Sofa 260 cm - Fabric Thuy color 4 / Tortora

BOULEVARD | Side Table, 60x30x42h cm Lava Rock finish

MIK | Coffee Table, 32x32x35h cm, matt lacquered finish color Muschio



VITTORIO | Right element 210 cm and Open Left element 160 cm

Fabric Thuy color 4 / Tortora - Small cushions Fabric Dhogar color 14 / Zolfo

ISLAND | Coffee Table, 130x100x20 cm and Top 80x80x12h cm, gloss lacquered finish color Muschio

BOULEVARD | Consolle, 150x35x42h cm, Lava Rock finish

MIK | Coffee Table, 32x32 x 35 h and 45 h cm, matt lacquered finish color Muschio





Cloud

bracciolo sx

raggio
3cm

fronte bracciolo



CLOUD | Left element 135 cm, Pouf 115x115 cm, Central element 100 cm and Chaise longue 160 cm
Leather Siviglia color 1028 / Verderame - Small cushions Senky color 10 / Phard
BOULEVARD | Coffee Table, 90x90x32h cm, Lava Rock finish
MIK | Coffee Table, 32x32x35h and 45h cm, gloss lacquered finish color Mattone

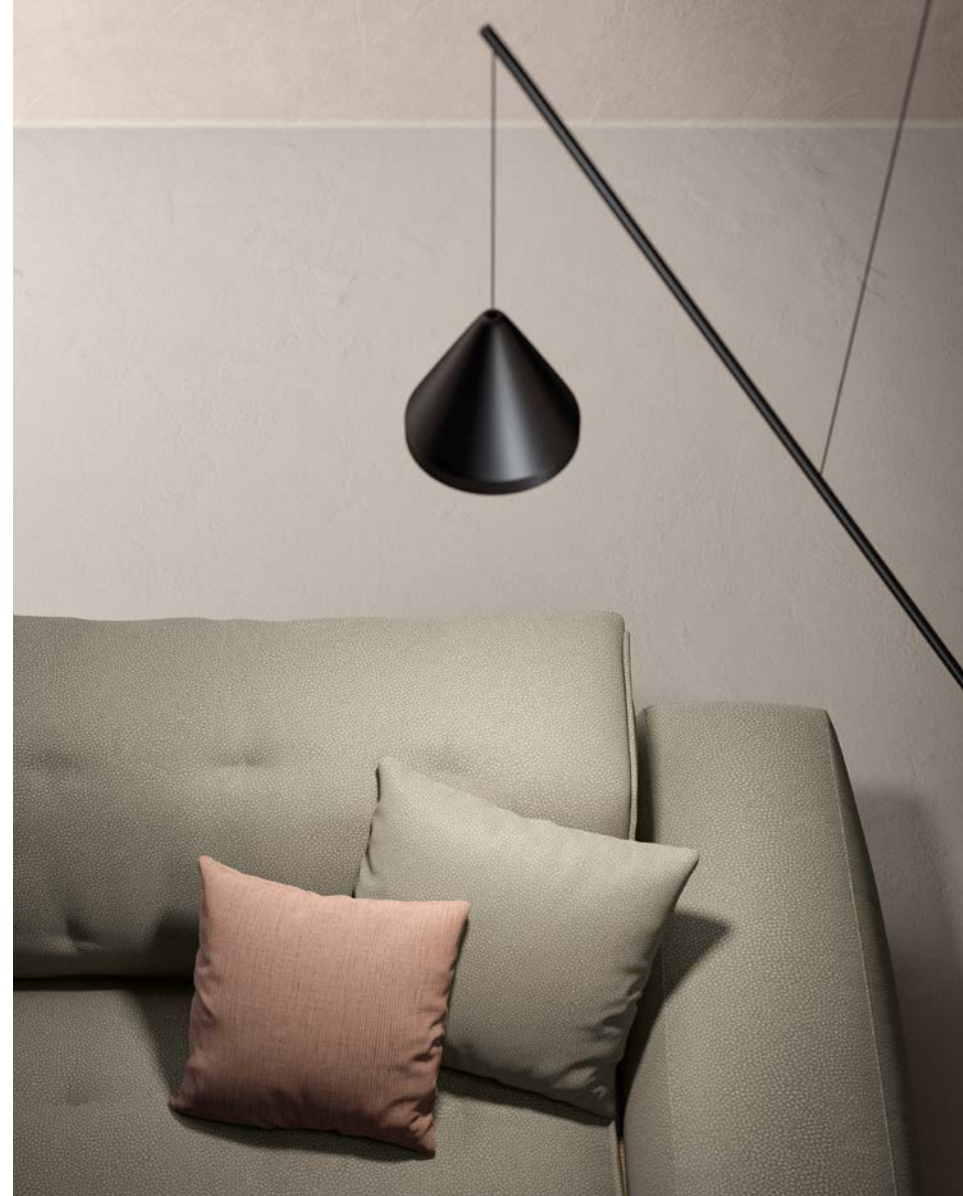

CLOUD | Left element 135 cm, Central element 100 cm and Pouf 115x115 cm
Fabric Senky color 8 / Asfalto - Small cushions Senky color 10 / Phard
BOULEVARD | Coffee Table, 90x90x32h cm, Lava Rock finish
MIK | Coffee Table, 32x32x35h, gloss lacquered finish color Mattone



CLOUD | Sofa 250 cm

Fabric Senky color 8 / Asfalto - Small cushions Senky color 10 / Phard

ISLAND | Coffee Table, 130x100x20 cm and Top 130x50x12h cm, gloss lacquered finish color Pepe

BOULEVARD | Coffee Table, ø30x46h cm, gloss lacquered finish color Mattone

CLOUD | Left element 135 cm, Central element 100 cm, Pouf 115x115 cm and Right element 135 cm

Fabric Senky color 8 / Asfalto - Small cushions Senky color 10 / Phard

ISLAND | Coffee Table, 130x100x20 cm, Oakwood Natural color finish and Top 130x50x12h cm, gloss lacquered finish color Mattone

BOULEVARD | Coffee Table, ø30x46h cm, matt lacquered finish color Pepe





Mistral

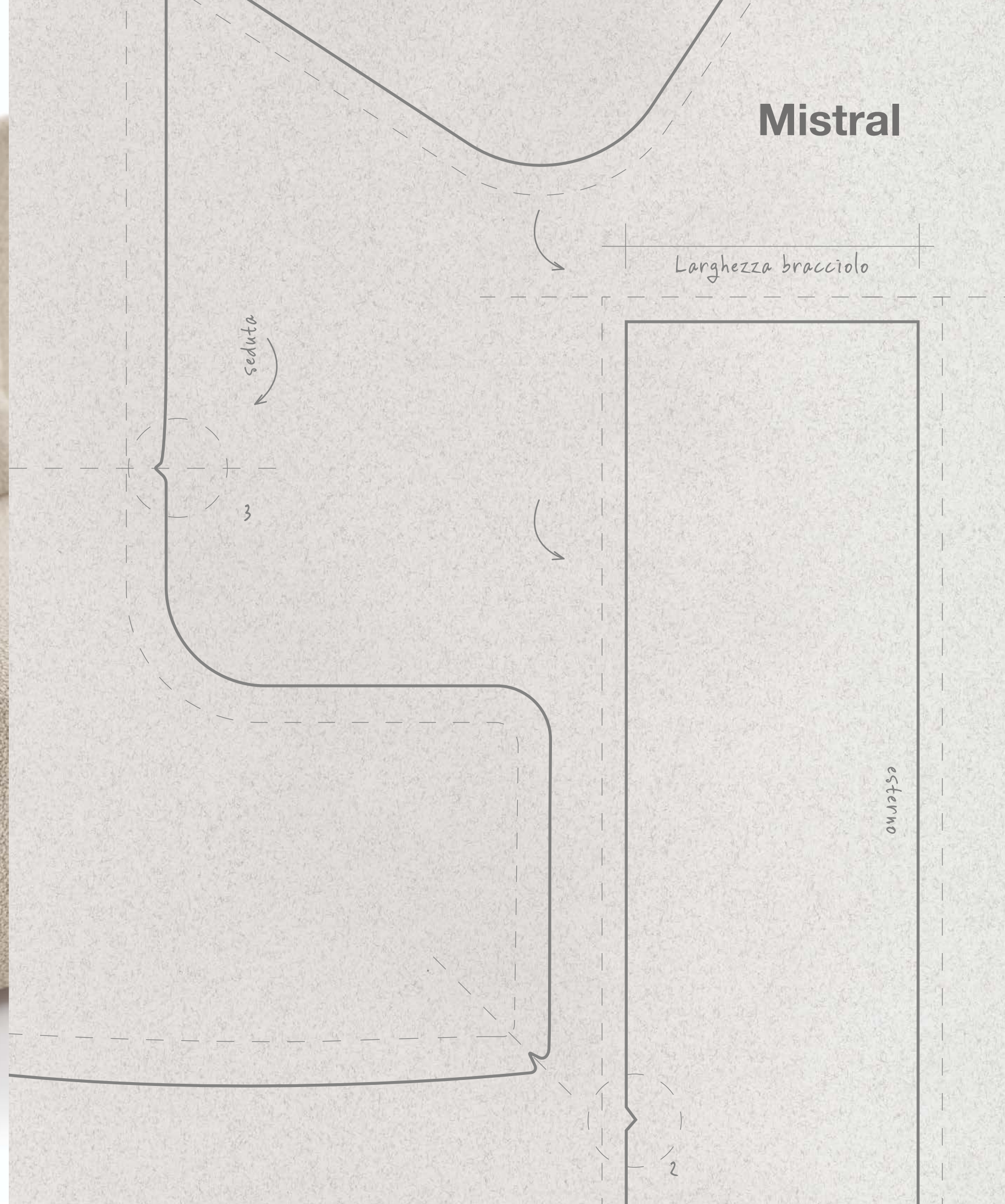



MISTRAL | Right element 135 cm, Long Corner, Central Element 100cm, pouf 115cm x 115cm
Fabric Baltimora color 4 / Nocciola - Small cushions Fabric Thuy color 1 / Latte
DOVER | Armchair, Fabric Dhogar color 23 / Ombra
ISLAND | Coffee Table, 130x100x20 cm, Oakwood, Walnut color finish
BOULEVARD | Coffee Table, ø30x46h cm, Lava Rock finish
PANTHEON | Rug, 300x400 cm, color 82187 / Tortora

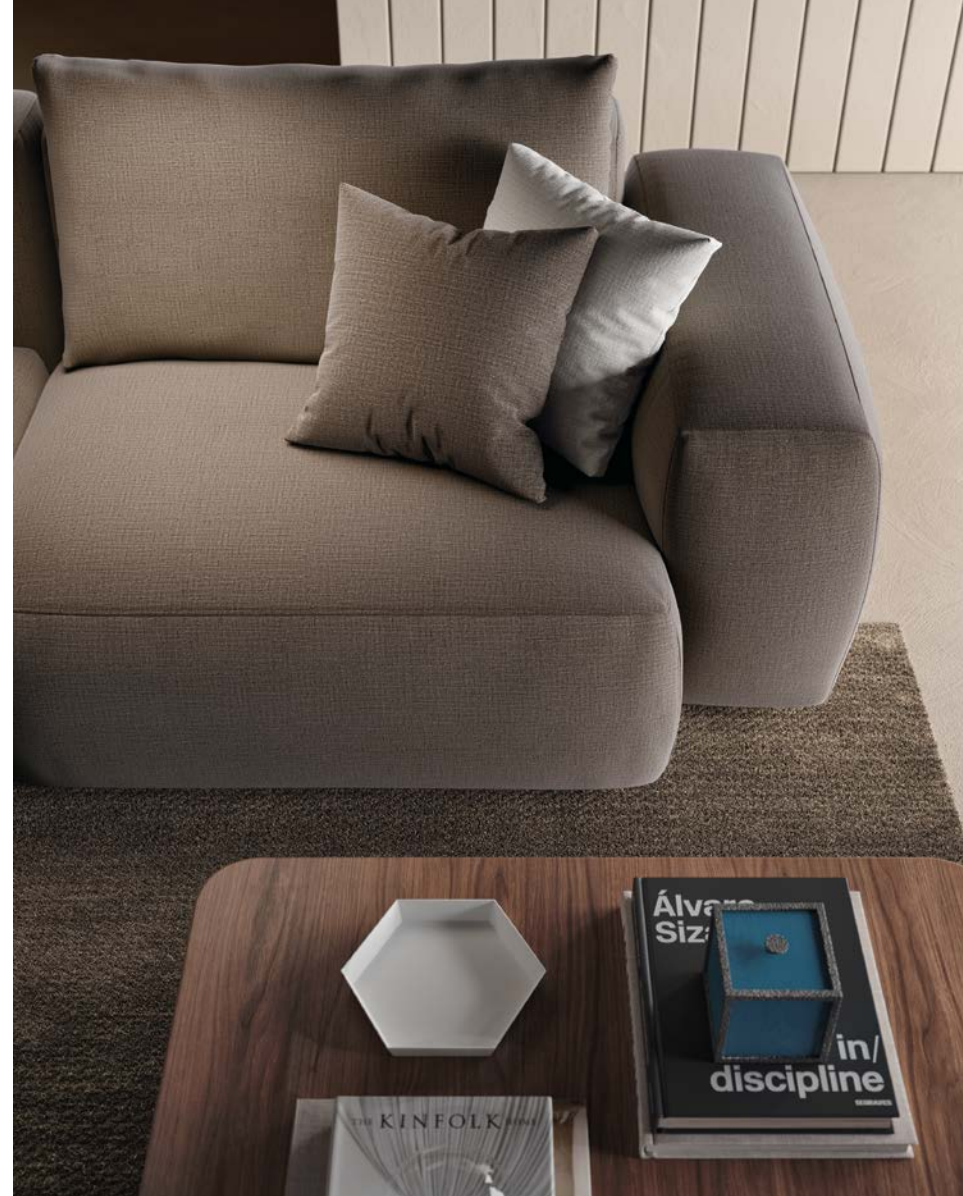



MISTRAL | Right element 135 cm, Central element 100 cm and Chaise Longue 160 cm
Fabric Thuy color 1 / Latte - Small cushions Fabric Dhogar color 23 / Ombra
ISLAND | Coffee Table, 130x100x20 cm and Top ø80x12h cm, gloss lacquered finish color Pepe
BOULEVARD | Coffee Table, 30x30x46h cm and Side Table 60x30x42h cm matt lacquered finish color Oltremare

MISTRAL | Sofa 250 cm

Fabric Thuy color 1 / Latte - Small cushions Fabric Dhogar color 23 / Ombra

BOULEVARD | Coffee Table, ø30x46h cm, matt lacquered finish color Oltremare





Aland

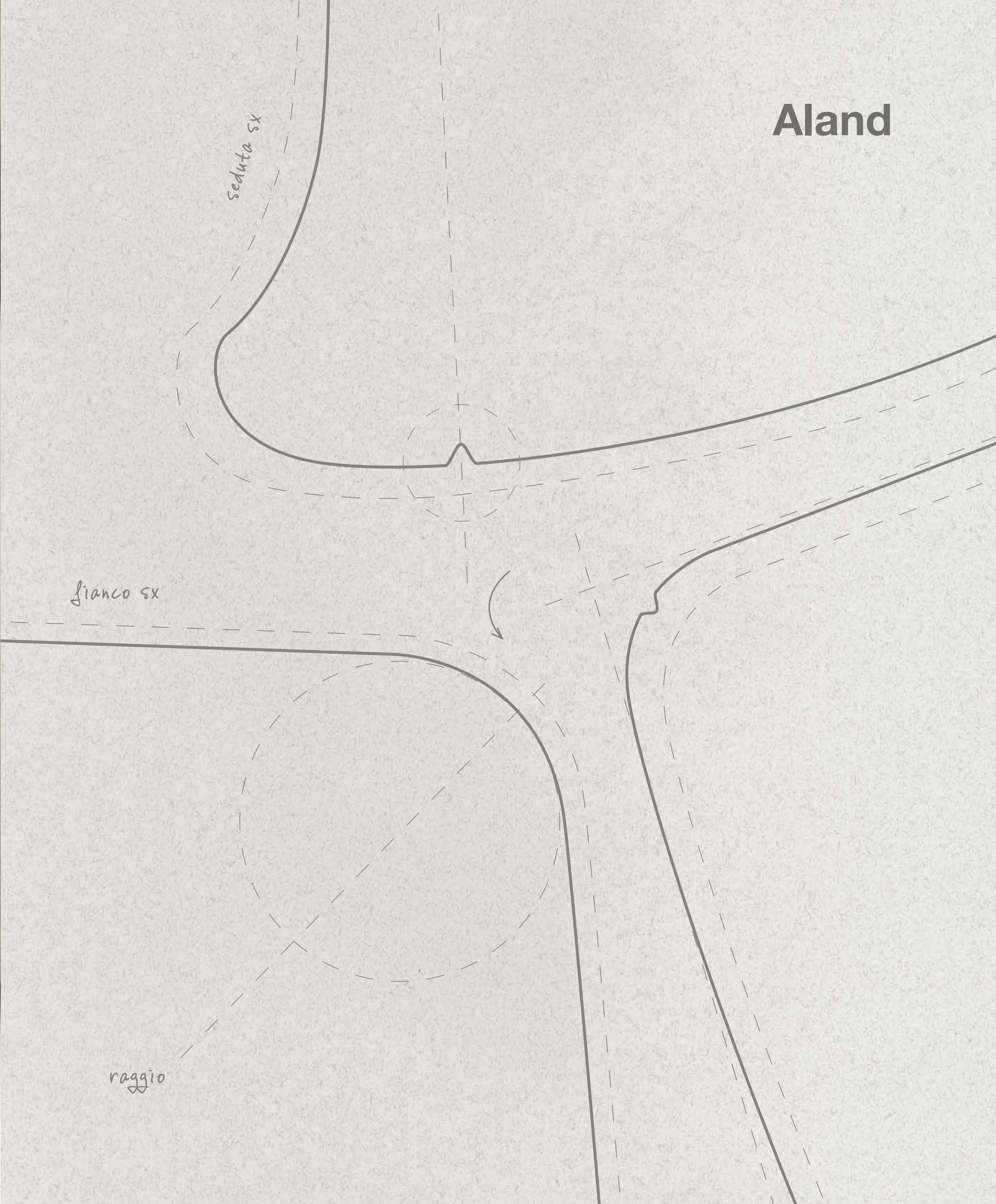



ALAND | Sofa 265 cm
Fabric Barnum color 8 / Giada
BUMPER | Swivel Armchair, Fabric Senky color 5 / Crusca and leather Siviglia color Ebanò
BOULEVARD | Coffee Table, 90x90x32 h cm, Lava Rock finish
MIK | Coffee Table, 32x32x35 h cm, gloss lacquered finish color Mattone



ALAND | Sofa 245 cm
Fabric Senky color 5 / Crusca - Small cushions Senky color 10 / Phard
MIK | Coffee Table, 32x32x45 h cm, gloss lacquered finish color Mattone



ALAND | Sofa 245 cm
Fabric Senky color 5 / Crusca - Small cushions Senky color 10 / Phard
ALAND | Armchair, Fabric Barnum color 8 / Giada
BOULEVARD | Coffee Table, 32x32x45 h cm, 90x90x32 h cm, Dark Grey Stone finish
MIK | Coffee Table, 32x32x45 h cm, gloss lacquered finish color Mattone





ALAND | Right element 185 cm and Chaise Longue 220 cm

Fabric Barnum color 2/ Corda - Small cushions Fabric Dhogar color 22/ Blu

BOULEVARD | Coffee Table, 90x90x32h cm, matt lacquered finish color Pepe and Ø30x46h cm Lava Rock finish
Console, 150x35x42h cm, Dark Grey Stone finish





Aland_Armchair



ALAND | Armchair, Fabric Thuy color 6 / Mattone

<ALAND | Armchair, Fabric Senky color 10 / Phard

<MIK | Coffee table, 32x32x45 h cm, matt lacquered finish color Pepe

Bumper



BUMPER | Swivel Armchair, Fabric Senky color 5 / Crusca and Leather Siviglia color Ebano

BUMPER | Swivel Armchair, Fabric Senky color 5 / Crusca

>BUMPER | Armchair, Fabric Senky color 5 / Crusca and Leather Siviglia color Ebano

>MIK | Coffee table, 32x32x45 h cm, matt lacquered finish color Mattone





Bumper_Lounge



BUMPER LOUNGE | Armchair, Fabric Paddy color 11 / Grigio

ELLIOT COLORS | Coffee Table, ø42x46 h cm, gloss lacquered finish color Mattone

<**BUMPER LOUNGE** | Armchair, Fabric Paddy color 9 / Grafite and leather Siviglia color Antracite

<**ELLIOT COLORS** | Coffee Table, ø42x46 h cm, gloss lacquered finish color Mattone

Dover



DOVER | Armchair, Fabric Dhogar color 3 / Polvere
>DOVER | Armchair, Fabric Barnum color 2 / Corda
>ISLAND | Coffee Table 130x100x20 cm, Oakwood, Walnut color finish
>BOULEVARD | Coffee Table, Ø30x46h cm Lava Rock finish





Island



ISLAND | Coffee Table, 130x100x20h cm, Oakwood, Walnut color finish with Top 130x50x12h cm and ø80x12h cm matt lacquered finish color Mattone and Pepe
<ISLAND | Coffee Table, 130x100x20h cm with Top ø80x12h cm matt lacquered finish color Mattone



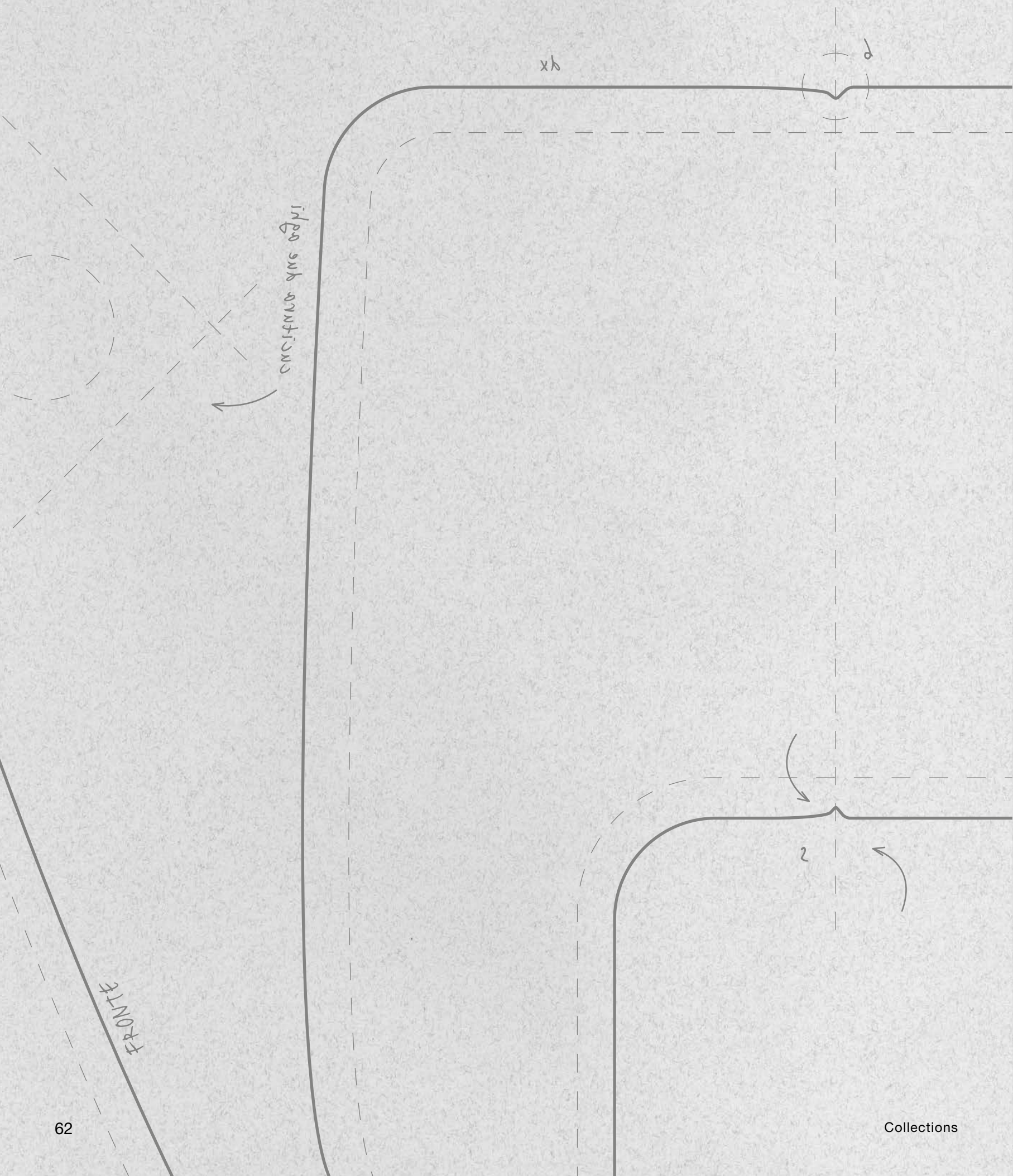

Technical data
Technische daten

Vittorio

Sofa



Design_Vittorio Marelli

STRUTTURA | legno di abete (Picea Abies) e multistrato, con cinghie elastiche.

IMBOTTITURA STRUTTURA | poliuretano espanso rivestito con fibra in poliestere resinata da 200 gr/m2 accoppiata a tessuto in poliestere elasticizzato.

SEDUTA | poliuretano espanso a densità differenziate rivestito con fibra in poliestere resinata da 200 gr/m2 accoppiata a tessuto in poliestere elasticizzato.

CUSCINI SCHIENALE | fodera in 100% cotone imbottita con microsere di poliestere "rollofil".

PIEDI | estrusione in alluminio, finitura color nikel nero oppure in legno massello di noce.

RIVESTIMENTO | completamente sfoderabile in tessuto, fisso in pelle.

FRAME | fir-wood (Picea Abies) and plywood with elastic straps.

FRAME PADDING | polyurethane foam covered with 200gr/m2 resin-bonded polyester coupled with elastic polyester fabric.

SEAT | polyurethane foam with different density layers covered with 200gr/m2 resin-bonded polyester coupled with elastic polyester fabric.

BACK CUSHIONS | 100% cotton cover padded with "rollofil" polyester.

FEET | aluminium extrusion with black nikel finish or solid walnut wood, natural finish.

COVERS | completely removable with fabric, fixed with leather.

GESTELL | Massive Fichte (Picea Abies) mit Multiplex, bespannt mit elastischen Gewebegurten.

AUFBAU | Polyurethanschaum in verschiedenen Raumgewichten, bezogen mit Polyestergewebe (200g/m2)

RÜCKENKISSEN | 100% Baumwollunterbezug mit "rollofil" Flocken.

FÜßE | Aluminium schwarzchrom oder Holz.

BEZUG | In Stoff komplett abziehbar, Leder festgepolstert.

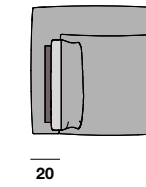
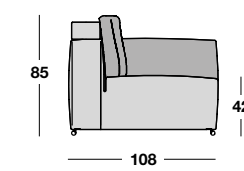

Sofas

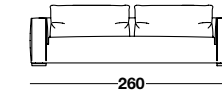
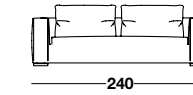
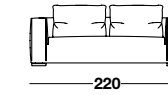
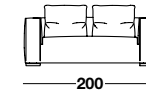

Left and Right elements

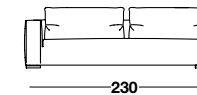
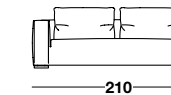
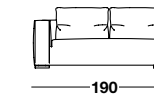
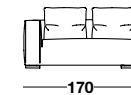

Central elements

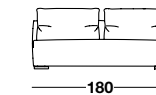
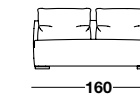
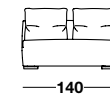

Left and Right open elements

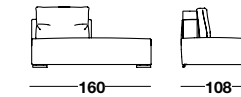
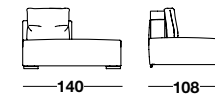

Chaise Longue

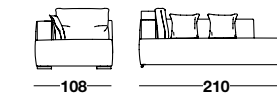
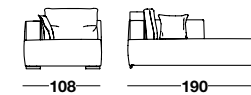

Corner

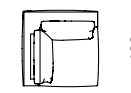

Long Corner

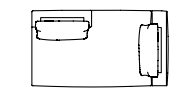
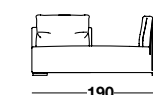
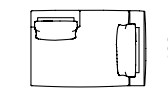
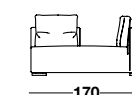

Pouf

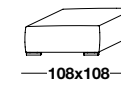
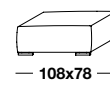

Cloud

Sofa



Design_Enrico Cesana

STRUTTURA | legno di abete (Picea Abies) e multistrato, con cinghie elastiche.

IMBOTTITURA STRUTTURA | poliuretano espanso a densità differenziate, rivestito con fodera in fibra di poliestere resinata da 100 gr/m2 accoppiata a tessuto in poliestere elasticizzato.

CUSCINI SEDUTA E SCHIENALE | topper realizzato con inserto in espanso e con microsfere di poliestere "rollofill".

RIVESTIMENTO | completamente sfoderabile in tessuto, fisso in pelle.

FRAME | fir-wood (Picea Abies) and plywood with elastic straps.

FRAME PADDING | polyurethane foam with different density layers, upholstered with 100 gr/m2 resin-bonded polyester coupled with elastic polyester fabric.

SEAT AND BACK CUSHIONS | topper crafted with soft foam and "rollofill" polyester.

COVER | fabric completely removable, fixed in leather.

GESTELL | Massive Fichte (Picea Abies) mit Multiplex, bespannt mit elastischen Gewebegurten.

AUFBAU | Polyurethanschaum in verschiedenen Raumgewichten, bezogen mit Polyestergewebe (100g/m2).

SITZ-RÜCKENAUFLAGE | Topper mit Schaumstoffeinlage und „rollofill“ – Flocken.

BEZUG | in Stoff komplett abziehbar, Leder festgepolstert.

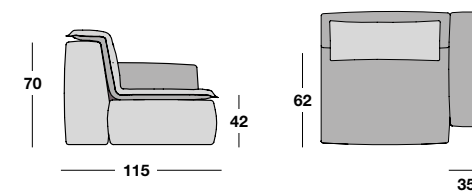

Sofas

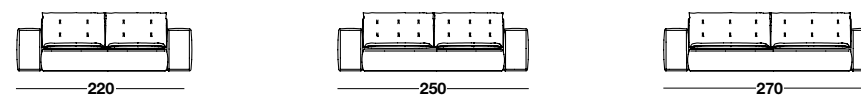

Left and Right elements

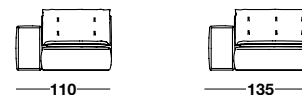

Central elements



Chaise Longue

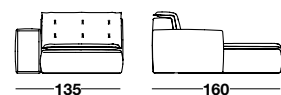

Dormeuse

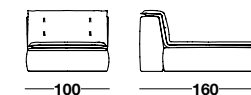

Corner



Long Corner

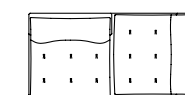
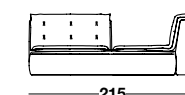

Pouf



Mistral

Sofa



Design_ Enrico Cesana

STRUTTURA | legno di abete (Picea Abies) e multistrato, con cinghie elastiche.

IMBOTTITURA STRUTTURA | poliuretano espanso a densità differenziate, rivestito con fodera in fibra di poliestere resinata da 100 gr/m2 accoppiata a tessuto in poliestere elasticizzato.

CUSCINI SCHIENALE | fodera in cotone 100% con microsfere di poliestere "rollofill".

RIVESTIMENTO | completamente sfoderabile in tessuto, fisso in pelle.

FRAME | fir-wood (Picea Abies) and plywood with elastic straps.

FRAME AND SEAT PADDING | polyurethane foam with different density layers, upholstered with 100 gr/m2 resin-bonded polyester coupled with fabric in elastic polyester.

BACK CUSHIONS | 100% cotton cover with "rollofill" polyester.

COVER | fabric completely removable, fixed in leather.

GESTELL | Massive Fichte (Picea Abies) mit Multiplex, bespannt mit elastischen Gewebegurten.

AUFBAU | Polyurethanschaum in verschiedenen Raumgewichten, bezogen mit Polyestergewebe (100g/m2)

RÜCKENKISSEN | 100% Baumwollunterbezug mit „ rollofil „ Flocken.

BEZUG | In Stoff komplett abziehbar, Leder festgepolstert.

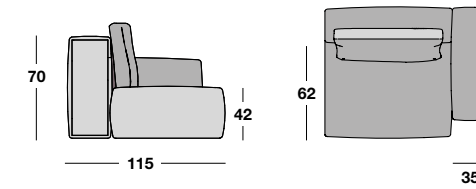

Sofas

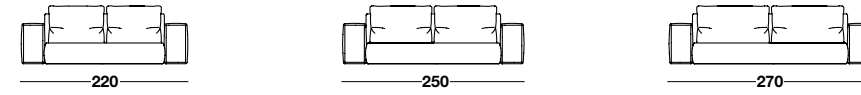

Left and Right elements

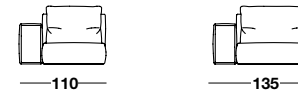

Central elements



Chaise Longue

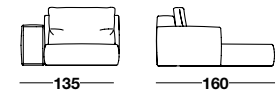

Dormeuse

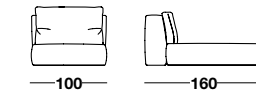

Corner



Long Corner

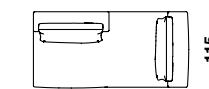
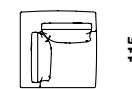
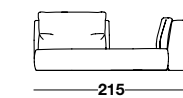

Pouf

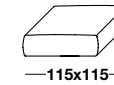
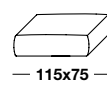

Aland

Sofa



Design_ Enrico Cesana

STRUTTURA | legno di abete (Picea Abies) e multistrato, con cinghie elastiche.

IMBOTTITURA STRUTTURA | poliuretano espanso a densità differenziate rivestito con fibra in poliestere resinata da 100 gr/mt2 accoppiata a tessuto in poliestere elasticizzato.

CUSCINI SEDUTA | poliuretano espanso, rivestito con fibra in poliestere resinata da 100 gr/mt2 accoppiata a tessuto in poliestere elasticizzato.

CUSCINI SCHIENALE | fodera in 100% cotone imbottita con microsfere di poliestere "rollofil".

PIEDI | metallo, finitura nickel nero.

RIVESTIMENTO | completamente sfoderabile in tessuto, fisso in pelle.

FRAME | fir-wood (Picea Abies) and plywood with elastic straps.

FRAME PADDING | polyurethane foam with different layers, covered with 100gr/M2 resin-bonded polyester coupled with elastic polyester fabric.

SEAT CUSHIONS | polyurethane foam covered with 100gr/M2 resin-bonded polyester coupled with elastic polyester fabric.

BACK CUSHIONS | 100% cotton cover, padded with "rollofil" polyester.

FEET | metal, black nickel finish.

COVERS | fabric completely removable, fixed with leather.

UNTERBAU | Gewebegurten auf Holzgestell mit Schichtholzverkleidung, bezogen mit Polyurethanschaum in verschiedenen Raumgewichten.

SITZKISSEN | Sandwichkissen in Polyurethanschaum und Baumwollbezug.

RÜCKENKISSEN | Rollofil-Füllung in Baumwollbezug.

METALLFÜßE | schwarzchrom.

BEZUG | In Stoff komplett abziehbar, Leder festgepolstert.

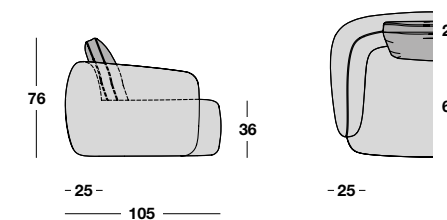

Sofas

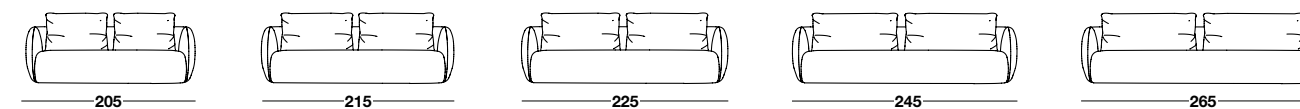

Left and Right elements



Central elements

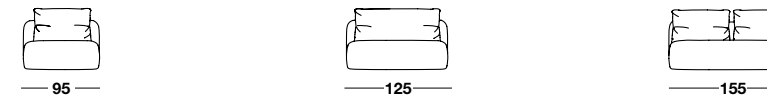

Left and Right open elements



Chaise Longue

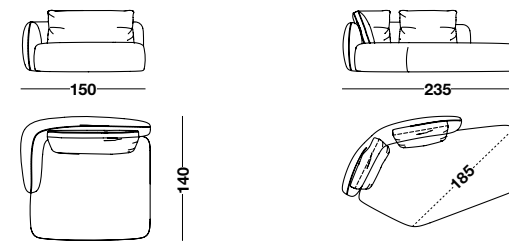

Corner

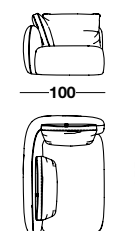

Aland_Armchair

Armchair

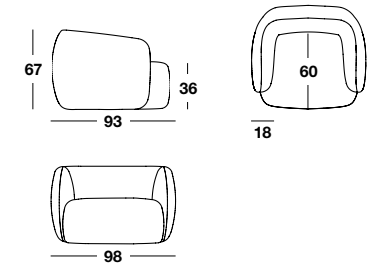

STRUTTURA | legno di abete (Picea Abies) e multistrato, con cinghie elastiche.

IMBOTTITURA STRUTTURA | poliuretano espanso a densità di erenziate, rivestito con fodera in bra di poliestere resinata da 100 gr/m2 accoppiat a a tessuto in poliestere elasticizzato. **BASE** | base girevole in metallo. **RIVESTIMENTO** | fisso in tessuto e in pelle.

FRAME | fir-wood (Picea Abies) and plywood with elastic straps.

FRAME PADDING | polyurethane foam, upholstered with 100 gr/m2resin-bonded polyester coupled with fabric in elastic polyester.

BASE | metal swivel base. **COVER** | fixed both in fabric and in leather.

UNTERBAU | Gewebegurten auf Holzgestell mit Schichtholzverkleidung bezogen mit Polyurethanschaum in verschiedenen Raumgewichten.

SITZKISSEN | Sandwichkissen mit Schaumkern 420gr/m2 und Watteabdeckung mit Baumwollbezug.

KISSEN | Gänsedaunen, abgekammert mit Baumwollbezug. **GESTEL** | Metallgestell, drehbar. **BEZUG** | Festgepolstert, sowohl in Stoff als auch in Leder.

Design_Enrico Cesana

Bumper

Armchair

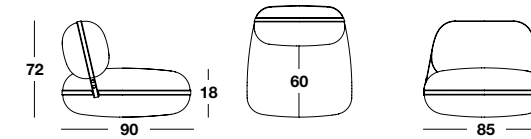

STRUTTURA | Legno di abete (Picea Abies) e multistrato, con cinghie elastiche.

IMBOTTITURA STRUTTURA | poliuretano espanso a densità differenziate, rivestito con fodera in fibra di poliestere resinata da 100 gr/m2 accoppiata a tessuto in poliestere elasticizzato. **RIVESTIMENTO** | fisso in tessuto e in pelle.

CINGHIE DECORATIVE | realizzate con tessuto di rivestimento della poltrona o in pelle Siviglia nei colori Ghiaia, Ebano, Antracite.

Versione Plus con base girevole in metallo.

FRAME | fir-wood (Picea Abies) and plywood with elastic straps.

PADDING | polyurethane foam, upholstered with 100 gr/m2resin-bonded polyester coupled with fabric in elastic polyester.

COVER | fixed both in fabric and in leather **DECORATIVE STRAP** | crafted with fabric used for armchair or in leather Siviglia, colors Ghiaia, Ebano, Antracite.

"Plus" Version, with metal swivel base.

GESTELL | Massive Fichte (Picea Abies) mit Multiplex, bespannt mit elastischen Gewebegurten.

AUFBAU | Polyurethanschaum in verschiedenen Raumgewichten, bezogen mit Polyestergewebe (100g/m2)

BEZUG | In Stoff und in Leder festgepolstert **DEKORATIVBÄNDER** | In Stoff des Sessels oder in Sviglia-Leder in den Farben: Ghiaia,Ebano,Antracite

"Plus" Version mit Drehfuß aus Metall.

Bumper_Lounge

Chaise Longue

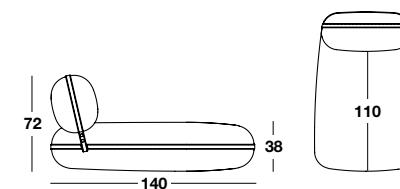

STRUTTURA | Legno di abete (Picea Abies) e multistrato, con cinghie elastiche.

IMBOTTITURA STRUTTURA | poliuretano espanso a densità differenziate, rivestito con fodera in fibra di poliestere resinata da 100 gr/m2 accoppiata a tessuto in poliestere elasticizzato.**RIVESTIMENTO** | fisso in tessuto e in pelle.

CINGHIE DECORATIVE | realizzate con tessuto di rivestimento della poltrona o in pelle Siviglia nei colori Ghiaia, Ebano, Antracite

FRAME | fir-wood (Picea Abies) and plywood with elastic straps.

PADDING | polyurethane foam, upholstered with 100 gr/m2resin-bonded polyester coupled with fabric in elastic polyester.

COVER | fixed both in fabric and in leather

DECORATIVE STRAP | crafted with fabric used for armchair or in leather Siviglia, colors Ghiaia, Ebano, Antracite

GESTELL | Massive Fichte (Picea Abies) mit Multiplex, bespannt mit elastischen Gewebegurten.

AUFBAU | Polyurethanschaum in verschiedenen Raumgewichten, bezogen mit Polyestergewebe (100g/m2)

BEZUG | In Stoff und in Leder festgepolstert

DEKORATIVBÄNDER | In Stoff des Sessels oder in Sviglia-Leder in den Farben: Ghiaia,Ebano,Antracite

Design_Enrico Cesana

Design_Enrico Cesana

Dover

Armchair

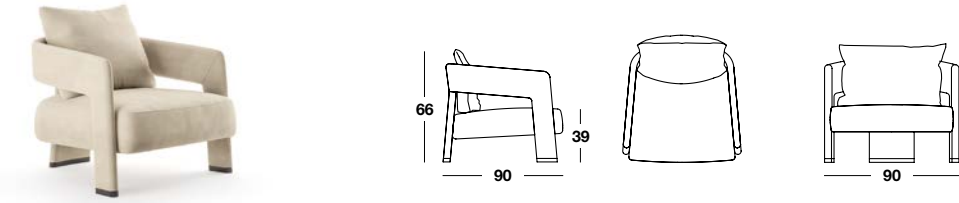

STRUTTURA | legno di abete e multistrato curvato **IMBOTTITURA STRUTTURA** | poliuretano espanso.

SEDUTA | poliuretano espanso a densità differenziate. **CUSCINO SCHIENALE** | fodera in 100% cotone imbottita con microsfere di poliestere "rollofil".

RIVESTIMENTO | fisso in tessuto ed in pelle.

FRAME | fir-wood (Picea Abies) and plywood. **FRAME PADDING** | polyurethane foam

SEAT CUSHION | polyurethane foam with different density layers. **BACK CUSHION** | 100% cotton cover, padded with "rollofil" polyester.

COVER | fixed both in fabric and leather

GESTELL | Massive Fichte (Picea Abies) mit gebogenem Multiplex und Polyurethan-Schaum.

SITZ | Polyurethanschaum in verschiedenen Raumgewichten, bezogen mit Polyestergewebe (100g/m²)

RÜCKENKISSEN | 100% Baumwollunterbezug mit "rollofil" Flocken.

BEZUG | In Stoff und Leder festgepolstert

Leslie

Swivel Armchair

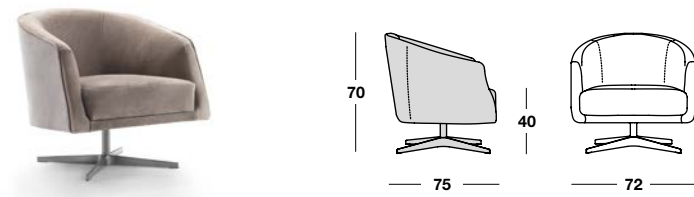

STRUTTURA | legno di abete (Picea Abies) e multistrato, con cinghie elastiche.

IMBOTTITURA STRUTTURA | poliuretano espanso a densità di erenziate, rivestito con fodera in bra di poliestere resinata da 100 gr/m² accoppiata a a tessuto in poliestere elasticizzato. **BASE** | base girevole in metallo. **RIVESTIMENTO** | fisso in tessuto e in pelle.

FRAME | fir-wood (Picea Abies) and plywood with elastic straps.

FRAME PADDING | polyurethane foam, upholstered with 100 gr/m²resin-bonded polyester coupled with fabric in elastic polyester.

BASE | metal swivel base. **COVER** | fixed both in fabric and in leather.

UNTERBAU | Gewebegurten auf Holzgestell mit Schichtholzverkleidung bezogen mit Polyurethanschaum in verschiedenen Raumgewichten.

SITZKISSEN | Sandwichkissen mit Schaumkern 420gr/m² und Watteabdeckung mit Baumwollbezug.

KISSEN | Gänsedaunen, abgekammert mit Baumwollbezug. **GESTEL** | Metallgestell, drehbar. **BEZUG** | Festgepolstert, sowohl in Stoff als auch in Leder.

Design_Enrico Cesana

Island

Coffee Tables



Coffee tables

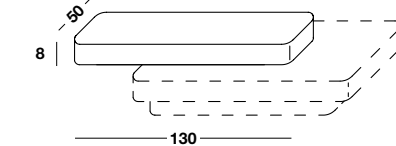
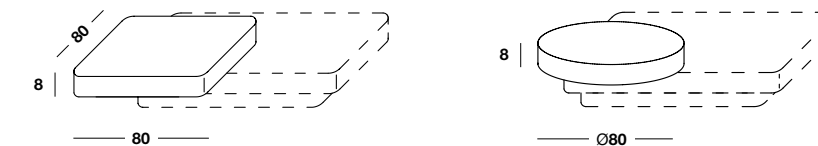
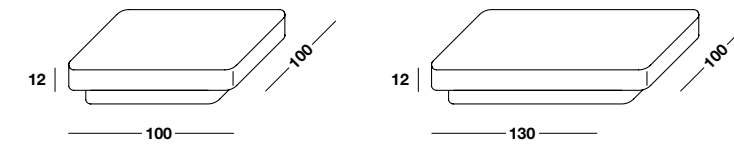

Collezione di tavolini in Rovere Naturale oppure laccati color Pepe, Mattone e Muschio.

Collection of coffee tables in Natural Oak or lacquered in Pepe, Mattone and Muschio colours.

Kollektion von Couchtischen in Eiche Natur oder lackiert in den Farben Pepe, Mattone und Muschio.



PEPE

MUSCHIO

MATTONE

Design_Marac Lab

Elliot & Elliot_Colours

Coffee Tables

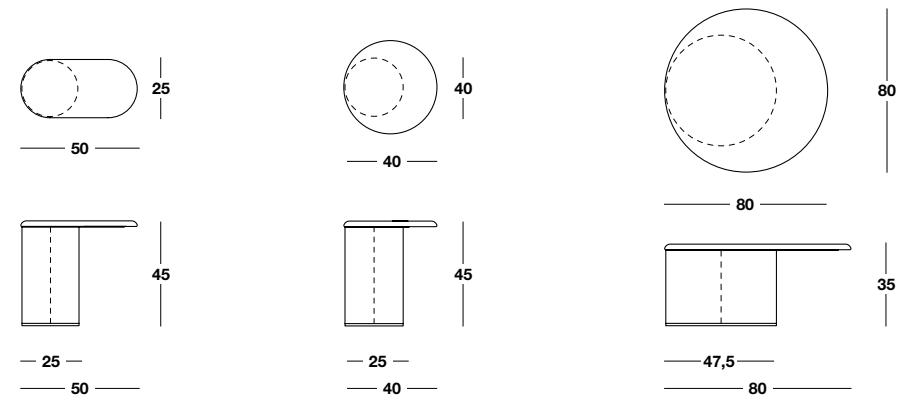

ELLIOT

Tavolini con base cilindrica realizzata con multistrato curvato e rivestito in cuoio, nei colori Grafite, Tortora e Caramello; top in marmo (spessore 20 mm) Calacatta Oro o Orobico Arabescato

Coffee tables with cylindrical base made with curved ply wood and covered with leather color Grafite, Tortora or Caramello; top with Calacatta Gold or Orobico Arabescato marble (20 mm thickness)

Couchtische mit zylindrischem Sockel aus gebogenem Multiplex, bezogen mit Kernleder in den Farben Grafite, Tortora oder Caramello; Platte aus Marmor Calacatta Gold oder Orobico Arabescato (20 mm Stärke)

ELLIOT_COLOURS

Tavolini con base cilindrica realizzata con multistrato curvato e con top in mdf, tutto completamente laccato con finitura opaca o lucida nei colori da campionario.

Coffee tables with cylindrical base made with curved plywood and top with mdf, lacquered with colours available from collection, matt or glossy finish.

Couchtische mit zylindrischem Sockel aus gebogenem Multiplex und Platte aus MDF, lackiert in den angebotenen Farben mit matter oder glänzender Oberfläche.



OLTREMARE PEPE MUSCHIO MATTONE PIOGGIA

Design_Enrico Cesana

Boulevard

Coffee Tables



Coffee tables

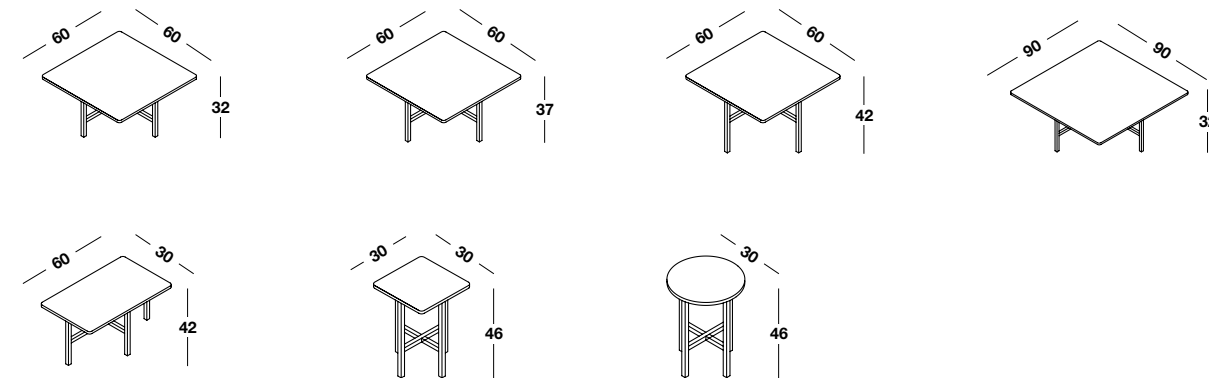

Consolle

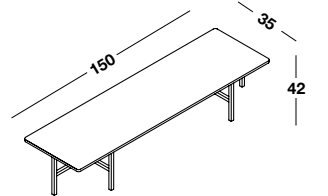

Tavolini e consolle con base in tubolare metallico Ø 10mm e top in mdf con varie finiture.

Finitura Pietra: granaglia di pietre e marmi spatolati manualmente nelle finiture Lava Rock, Dark Grey, Candoglia; base color Nero opaco.

Finitura Resina: resina colorata Rosso Oriente spatolata manualmente e poliestere; base color Nero opaco.

Finitura Laccata: laccatura opaca o lucida nei colori da campionario; base color Nero opaco o nei colori da campionario con finitura opaca.

Coffee table and consolle with Ø 10 mm metal base and top with mdf with variety of finishes.

Stone finish: granulated marbles and stones, spread by hand, in Lava Rock, Dark Grey, Candoglia finishes; Matt Black color for the base.

Resin finish: colored Rosso Oriente resin, spread by hand, and polyester; Matt Black color for the base.

Lacquered finish: matt or glossy lacquered colors available from collection; base with matt black or colors available from collection with matt finish

Couchtische und Konsolle mit Metallgestell Ø 10 mm in schwarz matt, Platte aus MDF in verschiedenen

Ausführung Stein: granulierter Marmor, in den Ausführungen Lava Rock, Dark Grey, Candoglia.

Ausführung Kunstharz-Finish: gefärbtes Harz Rosso Oriente, mit Polyester bezogen.

Lackierte Ausführung: lackiert in den angebotenen Farben mit matter oder glänzender Oberfläche, hier das Metallgestell in den Farben Schwarz oder in den angebotenen Farben mit matter Oberfläche.



OLTREMARE PEPE MUSCHIO MATTONE PIOGGIA ROSSO ORIENTE DARK GREY LAVA ROCK CANDOGLIA

Mik

Coffee Tables

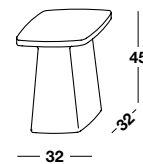
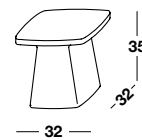

Tavolino in legno tornito, laccati con finitura opaca o lucida nei colori da campionario

Wooden small table, lacquered with matt or glossy finish, colors available from collection

Beistelltisch aus Holz, lackiert in matt oder hochglanz, Farben nach Muster.



OLTREMARE PEPE MUSCHIO MATTONE PIOGGIA

Design_Enrico Cesana

Lain

Pouf

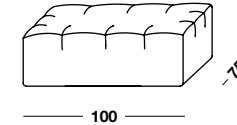
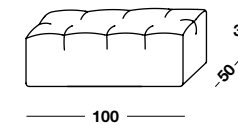
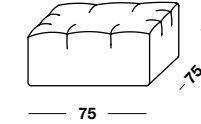
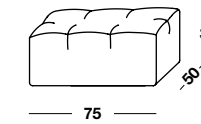

Pouf realizzato con struttura di poliuretano espanso ad alta densità, rivestito con poliestere resinato da 300gr/mt2 e fissato su basamento in multistrato da 15 mm. Rivestimento fisso.

Ottoman with frame made of high density polyurethane foam, covered with 300 gr/mt2 resin-bonded polyester, fixed on 15 mm thick plywood base. Fixed cover.

Hocker aus hochdichtem Polyurethanschaum, bezogen mit harzgebundenem Polyester von 300gr/m2, befestigt auf einer 15mm Sperrholzplatte. Bezug fest.

AD / Enrico Cesana

Graphic / CO3 Design Studio

Styling / Massimiliano Di Domenico

Render images / Virtual Design

Prepress / CD Cromo

Printing / Grafica Goia

Aprile 2023



Via Milano, 74
22063 Cantù (CO) Italy
T +39 031 711349
www.marac.it
info@marac.it

